

Lieferprogramm

Jansen-Economy 50 Fenster

Programme de livraison

Jansen-Economy 50 fenêtres

Sales range

Jansen-Economy 50 windows

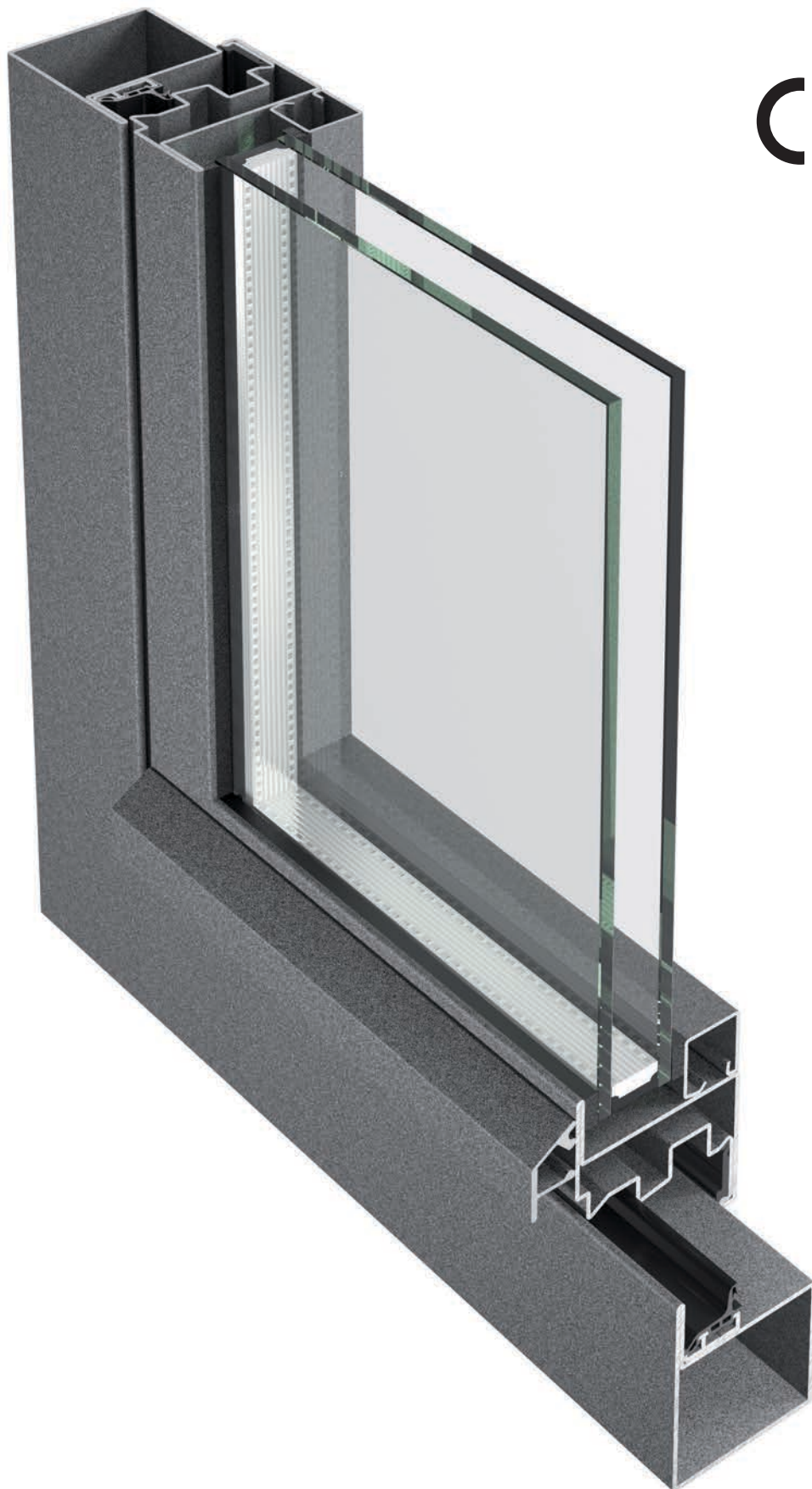

CE

Systemübersicht

Merkmale
Leistungseigenschaften
Typenübersicht

Sommaire du système

Caractéristiques
Caractéristiques de performance
Sommaire des types

Summary of system

Characteristics
Performance characteristics
Summary of types

2

Profilsortiment

Profilübersicht
Profile im Massstab 1:1
Glasleistenübersicht

Assortiment de profilé

Sommaire des profilés
Profilés à l'échelle 1:1
Sommaire des parclozes

Range of profiles

Summary of profiles
Profiles on scale 1:1
Summary of glazing beads

10

Zubehör

Zubehör
Beschlüge
Verarbeitungshilfen

Accessoires

Accessoires
Ferrures
Outils d'usinage

Accessories

Accessories
Fittings
Assembly tools

24

Beispiele

Schnittpunkte
Anwendungsbeispiele
Anschlüsse am Bau

Exemples

Coupes de détails
Exemples d'application
Raccords au mur

Examples

Section details
Examples of applications
Attachment to structure

121

Technische Hinweise**Conseils techniques****Technical data****135**

Alle Ausführungen dieser Dokumentation haben wir sorgfältig und nach bestem Wissen zusammengestellt. Wir können aber keine Verantwortung für die Benützung der vermittelten Vorschläge und Daten übernehmen. Wir behalten uns technische Änderungen ohne Vorankündigung vor.
Aktuelle Version auf www.jansen.com

Nous avons apporté le plus grand soin à l'élaboration de cette documentation. Cependant, nous déclinons toute responsabilité pour l'utilisation faite de nos propositions et de nos données.
Nous nous réservons le droit de procéder à des modifications techniques sans préavis.
Version actuelle sur www.jansen.com

All the information contained in this documentation is given to the best of our knowledge and ability. However, we decline all responsibility for the use made of these suggestions and data.
We reserve the right to effect technical modifications without prior warning.
Current version available at www.jansen.com

Merkmale

Caractéristiques

Characteristics

Jansen-Economy 50 Fenster

Jansen-Economy 50 fenêtres

Jansen-Economy 50 windows

Jansen-Economy 50 Fenster

- Stahlsystem für Fenster und Festverglasungen
- Bautiefe 50 mm, Fensterflügel 58,5 mm aussen flächenbündig
- Schmale Ansichtsbreiten: Sprossen 50 mm Rahmen inkl. Flügel ab 82 mm Stulppartie 103 mm
- Dreh- und Drehkippenfenster und Kippenfenster nach innen öffnend
- Systemlösungen für Bogen-, Segment- und Atelierfenster, Kipp vor Dreh und RFID-Überwachung
- Dreh- und Dreikipp-Fensterflügel bis 1475x2300 mm (BxH)
- Flügelgewichte: Standardbeschlag bis 150 kg Verdeckt liegender Beschlag bis 180 kg
- Füllelementstärken von 5 bis 35 mm, Glaseinbau mittels Nassverglasung
- Systemprüfungen nach Produktnorm EN 14351-1
- Stahlprofile blank oder bandverzinkt
- Geeignet für Pulver- und Nasslackbeschichtungen

Jansen-Economy 50 fenêtres

- Système en acier pour fenêtres et vitrages fixes
- Profondeur de montage 50 mm, vantail de fenêtre 58,5 mm montage à fleur à l'extérieur
- Fines largeurs de face: Meneau 50 mm Cadre avec vantail à partir de 82 mm Partie tête 103 mm
- Fenêtres ouvrant à la française et oscillo-battantes et fenêtres à soufflet à ouverture vers l'intérieur
- Systèmes pour fenêtres cintrées, à arc bombé et d'atelier, à ouverture inversée et surveillance RFID
- Vantaux à la française et oscillo-battants jusqu'à 1475x2300 mm (LxH)
- Poids de vantail: Ferrure standard jusqu'à 150 kg Ferrure de fenêtre non apparente jusqu'à 180 kg
- Éléments de remplissage de 5 à 35 mm d'épaisseur, montage du vitrage au silicone
- Contrôles des systèmes selon la norme produit EN 14351-1
- Profilés en acier brut ou galvanisé en continu
- Convient aux revêtements par poudre ou peinture liquide

Jansen-Economy 50 windows

- Steel system for windows and fixed glazing
- Basic depth 50 mm, window vent 58,5 mm flush-fitted on outside
- Narrow face widths: Sash bars 50 mm Frame including vent from 82 mm Double vent assembly 103 mm
- Side-hung and turn/tilt windows and bottom-hung windows, inward-opening
- System solutions for arched, segmented and studio windows, tilt-before-turn and RFID monitoring
- Side-hung and turn/tilt window vents up to 1475x2300 mm (WxH)
- Vent weights: Standard fittings up to 150 kg Concealed fittings up to 180 kg
- Infill unit thicknesses from 5 to 35 mm, glazing installed by means of wet glazing
- System tests in accordance with the product standard EN 14351-1
- Raw finish or pre-galvanised steel profiles
- Suitable for powder and wet paint coating

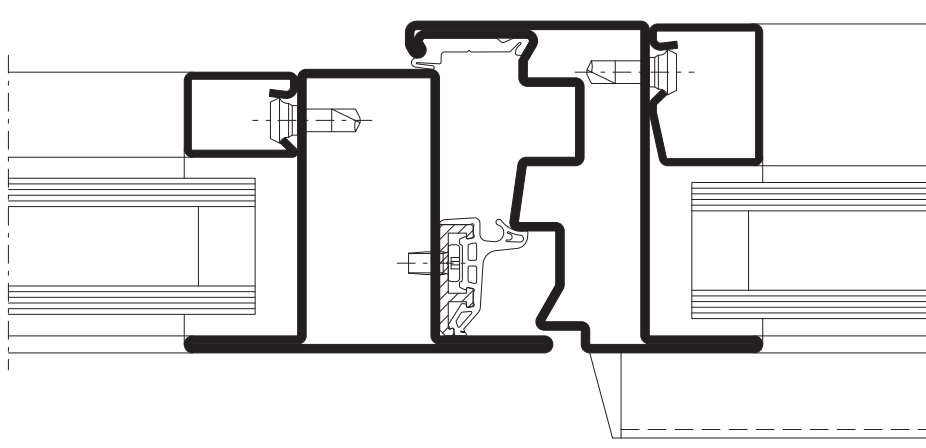



Isoliertes
Verre isolant
Insulating glass

Stahl-Glasleiste
Parclose en acier
Steel glazing bead

Distanzband/Versiegelung
Bande d'écartement/Scellement
Packing tape/Sealing

Distanzband/Versiegelung
Bande d'écartement/Scellement
Packing tape/Sealing

Flügelprofil
Profilé de vantail
Leaf profile

Anschlagdichtung
Joint de butée
Rebate weatherstrip

Wetterschenkel
Renvoi d'eau
Weatherbar

Mitteldichtung
Joint médian
Central weatherstrip

Aluminium-Zusatzprofil
Profilé complémentaire en aluminium
Aluminium additional profile

Rahmenprofil
Profilé de cadre
Frame profile

Jansen-Economy 50 Fenster Edelstahl

- Edelstahlsystem für Fenster und Festverglasungen
- Bautiefe 50 mm, Fensterflügel 58,5 mm aussen flächenbündig
- Schmale Ansichtsbreiten: Rahmen inkl. Flügel ab 82 mm
- Dreh- und Drehkippenfenster und Kippenfenster nach innen öffnend
- Systemlösungen für Bogen-, Segment- und Atelierfenster, Kipp vor Dreh und RFID-Überwachung
- Dreh- und Drehkippen-Fensterflügel bis 1475x2300 mm (BxH)
- Flügelgewichte: Standardbeschlag bis 150 kg Verdeckt liegender Beschlag bis 180 kg
- Füllelementstärken von 5 bis 32 mm, Glaseinbau mittels Nassverglasung
- Systemprüfungen nach Produktnorm EN 14351-1
- Edelstahlprofile aus Werkstoff 1.4404 (AISI 316L) und 1.4307 (AISI 304L) geeignet für Industriegebiete und Küstennähe
- Ausführung walzblank und geschliffen (Korn 220-240 ab Lager)

Jansen-Economy 50 fenêtres en acier Inox

- Système en acier inox pour fenêtres et vitrages fixes
- Profondeur de montage 50 mm, vantail de fenêtre 58,5 mm montage à fleur à l'extérieur
- Fines largeurs de face: Cadre avec vantail à partir de 82 mm
- Fenêtres ouvrant à la française et oscillo-battantes et fenêtres à soufflet à ouverture vers l'intérieur
- Systèmes pour fenêtres cintrées, à arc bombé et d'atelier, à ouverture inversée et surveillance RFID
- Vantaux à la française et oscillo-battants jusqu'à 1475x2300 mm (LxH)
- Poids de vantail: Ferrure standard jusqu'à 150 kg Ferrure de fenêtre non apparente jusqu'à 180 kg
- Éléments de remplissage de 5 à 32 mm d'épaisseur, montage du vitrage au silicone
- Contrôles des systèmes selon la norme produit EN 14351-1
- Profilés en acier inox en matériau 1.4404 (AISI 316L) et 1.4307 (AISI 304L), conviennent aux zones industrielles et à proximité des côtes
- Technique d'assemblage de profilés contrôlée selon EN 14024

Jansen-Economy 50 stainless steel windows

- Stainless steel system for windows and fixed glazing
- Basic depth 50 mm, window vent 58,5 mm flush-fitted on outside
- Narrow face widths: Frame including vent from 82 mm
- Side-hung and turn/tilt windows and bottom-hung windows, inward-opening
- System solutions for arched, segmented and studio windows, tilt-before-turn and RFID monitoring
- Side-hung and turn/tilt window vents up to 1475x2300 mm (WxH)
- Vent weights: Standard fittings up to 150 kg Concealed fittings up to 180 kg
- Infill unit thicknesses from 5 to 32 mm, glazing installed by means of wet glazing
- System tests in accordance with the product standard EN 14351-1
- Stainless steel profiles made from the material 1.4404 (AISI 316L) and 1.4307 (AISI 304L) suitable for industrial and coastal areas
- Sheet metal and polished finishes (grain 220-240 from the warehouse)

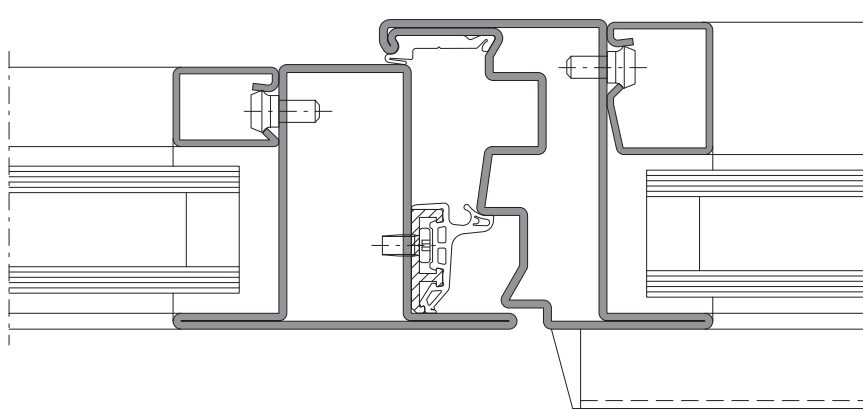



Isoliertes Glas
Verre isolant
Insulating glass

Edelstahl-Glasleiste
Parcloses en acier Inox
Stainless steel glazing bead

Distanzband/Versiegelung
Bande d'écartement/Scellement
Packing tape/Sealing

Distanzband/Versiegelung
Bande d'écartement/Scellement
Packing tape/Sealing

Flügelprofil
Profilé de vantail
Leaf profile









Anschlagdichtung
Joint de butée
Rebate weatherstrip

Wetterschenkel
Renvoi d'eau
Weatherbar

Mitteldichtung
Joint médian
Central weatherstrip

Aluminium-Zusatzprofil
Profilé complémentaire en aluminium
Aluminium additional profile

Rahmenprofil
Profilé de cadre
Frame profile

Norm	Eigenschaft Caractéristique Characteristic	Klassifizierung / Wert Classification / Valeur Classification / Value										
 EN 12210	Widerstandsfähigkeit gegen Windlast Résistance à la pression du vent Resistance to wind load	npd	C1 (400)	C2 (800)	C3 (1200)	C4 (1600)	C5 (2000)	Exxx (>2000)				
 EN 12208	Schlagregendichtheit Étanchéité à la pluie battante Watertightness	npd	1A (0)	2A (50)	3A (100)	4A (150)	5A (200)	6A (250)	7A (300)	8A (450)	9A (600)	Exxx (>600)
 EN ISO 140-3	Schallschutz R_w (C, C_{tr}) (dB) Isolation phonique R_w (C, C_{tr}) (dB) Sound insulation R_w (C, C_{tr}) (dB)	npd	bis R_w 43 dB (-2; -5) jusqu'à R_w 43 dB (-2; -5) up to R_w 43 dB (-2; -5)									
 EN ISO 10077-1	Wärmedurchgangskoeffizient U_w (W/(m²·K)) Transmission thermique U_w (W/(m²·K)) Thermal production U_w (W/(m²·K))	npd	ab 4,8 W/m ² ·K à partir de 4,8 W/m ² ·K from 4,8 W/m ² ·K									
 EN 12207	Luftdurchlässigkeit Perméabilité à l'air Air permeability	npd	1 (150)	2 (300)	3 (600)	4 (600)						
 EN 1522	Tragfähigkeit von Sicherheitsvorrichtungen Capacité portante des dispositifs de sécurité Load-bearing capacity of safety devices	Anforderung erfüllt Exigence remplie Requirement satisfied										
 EN 1522	Durchschusshemmung Résistance aux balles Bullet proofing	npd	FB1	FB2	FB3	FB4	FB5	FB6	FB7	FSG		
 EN 1627	Einbruchhemmung Anti-effraction Burglar resistance	npd	1	2	3	4	5	6				

npd = keine Leistung festgestellt
(no performance determined)

npd = Aucune performance déterminée
(no performance determined)

npd = no performance determined

Zur Erreichung der maximalen Leistungswerte sind die Gutachtlichen Stellungnahmen zu beachten.
(www.extranet.jansen.com)

Les prescriptions de l'avis d'expertise doivent être respectés pour obtenir les valeurs de performance maximales.
(www.extranet.jansen.com)

To achieve the maximum performance values, the provisions of appraisal report must be adhered to.
(www.extranet.jansen.com)

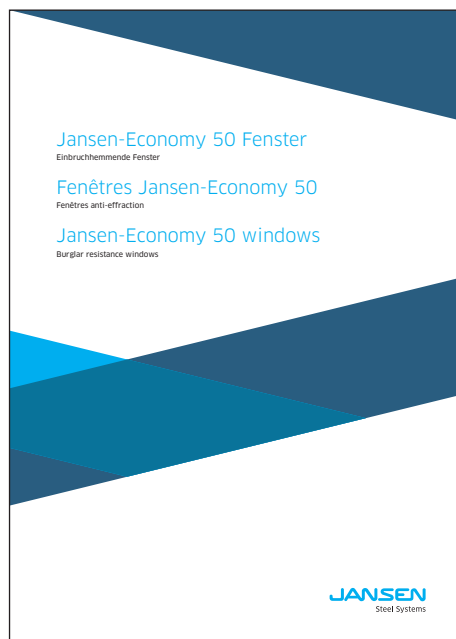

Einbruchhemmende Jansen-Economy 50 Fenster
Fenêtres Jansen-Economy 50 anti-effraction
Burglar resistance Jansen-Economy 50 windows

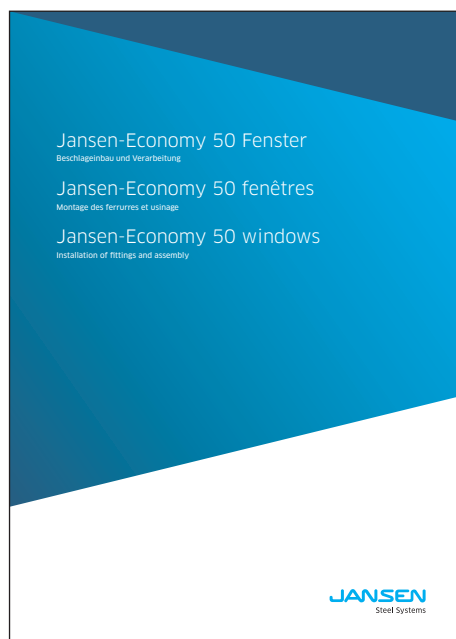

**Jansen-Economy 50 Fenster –
Beschlagenbau und Verarbeitung
(598.771)**

**Jansen-Economy 50 fenêtres –
Montage des ferrures et usinage
(598.771)**

**Jansen-Economy 50 windows –
Installation of fittings and assembly
(598.771)**



**Verarbeitung Jansen-Profilssysteme
(598.477)**

**Usinage systèmes de profilés Jansen
(598.491)**

**Fabrication of Jansen profile systems
(598.492)**



**Bedienungs-, Pflege- und
Wartungsanleitung (598.461)**

**Instructions d'emploi, d'entretien
et de maintenance (598.468)**

**Operating and maintenance
instructions (598.467)**

Online-Zugriff

extranet.jansen.com/bestellkatalog
Über diesen Link haben Sie direkten Zugriff auf die einzelnen Kapitel des Bestellkatalogs in Form von PDFs und können die darin verlinkten detaillierten CAD-Zeichnungen (DWG- und DXF-Dateien) gratis downloaden.

Voraussetzung ist Ihre Registrierung im Jansen Extranet.

Accès en ligne

extranet.jansen.com/catalogue
Ce lien vous donne un accès direct aux différents chapitres du catalogue de commande au format PDF et vous permet de télécharger gratuitement les dessins DAO (fichiers DWG et DXF) détaillés mis en lien qu'il contient.

Vous devez pour cela être enregistré dans l'Extranet Jansen.

Online access

extranet.jansen.com/ordercatalogue
Via this link, you can enjoy direct access to the individual chapters of the order manual in the form of PDFs and download the detailed CAD drawings linked to them (DWG and DXF files) free of charge.

To do so, you are required to register for the Jansen Extranet.

Erklärung

DXF

DWG

Sie können die Zeichnungen in den Formaten DXF und/oder DWG herunterladen. Klicken Sie auf das entsprechende Icon und der Download erfolgt.

Der Hinweis Artikelbibliothek bedeutet, dass Sie mit einem Klick die gesamte Artikelbibliothek des entsprechenden Systems herunterladen (Profile, Glasleisten, Zubehör etc.).

CAD-Beschlagsartikel finden Sie aufgrund der grossen Datenmenge per Klick auf einen separaten Link im Extranet.

Explication

DXF

DWG

Vous pouvez télécharger les dessins aux formats DXF et/ou DWG. Cliquez sur l'icône correspondante et le téléchargement s'effectuera.

L'indication Bibliothèque des articles signifie que vous téléchargez la totalité de la bibliothèque des articles du système donné (profilés, parclofes, accessoires etc.).

En raison de la grande quantité de données, vous trouverez les articles de ferrure DAO en cliquant sur un lien séparé de l'Extranet.

Explanation

DXF

DWG

You can download the drawings in DXF and/or DWG format. Click on the relevant icon to begin the download.

The item "Article library" means that you download the entire article library for the corresponding system with one click (profiles, glazing beads, accessories etc.).

Due to the large volume of data, you will find CAD fittings articles by clicking on a separate link in the Extranet.

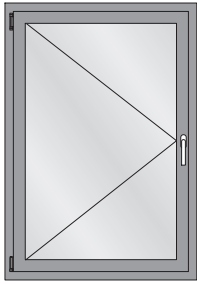

Drehflügel
 Fenêtre à la française
 Side-hung window

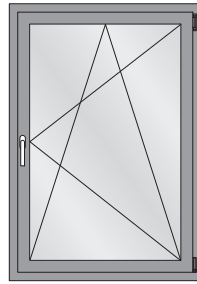

Drehkipp-Flügel
 Vantail oscillo-battant
 turn/tilt window

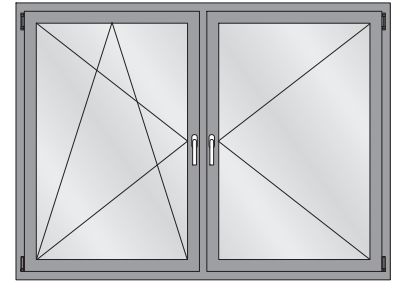

Drehkipp/Dreh-Flügel
 Vantail oscillo-battant/fenêtre à la française
 Side-hung/turn/tilt window

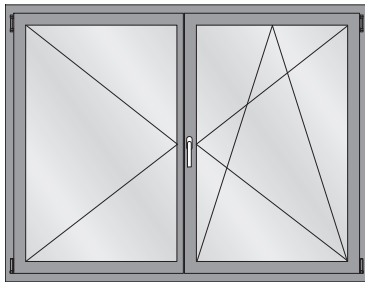

Stulpfenster
 Fenêtre à deux vantaux
 Double leaf window

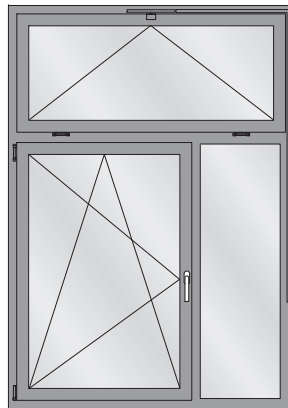

Fenster Drehkipp mit Festverglasung
 Vantail oscillo-battant avec vitrage fixe
 Window, turn/tilt with fixed lights

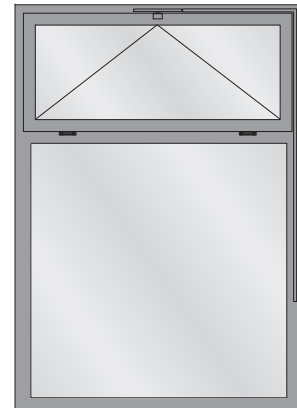

Festverglasung mit Oberlicht
 Vitrage fixe avec imposte
 Fixed lights with top light

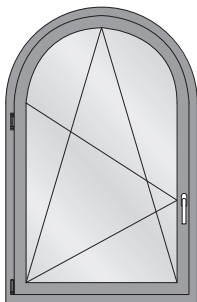

Einflügeliges Rundbogen-Fenster
 Fenêtre à un vantail à plein-cercle
 Single leaf round arched window

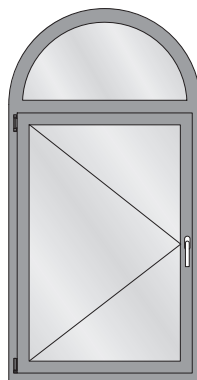

Einflügeliges Fenster mit Rundbogen-Oberlicht
 Fenêtre à la française avec imposte demi-rond
 Side hung window with round arched top light

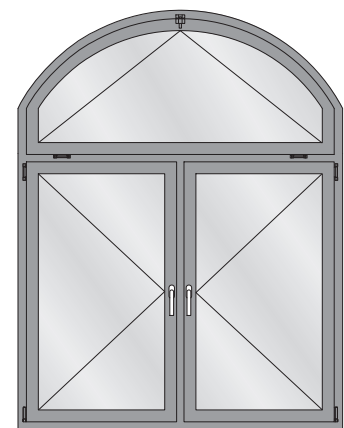

Zweiflügeliges Fenster mit Stichbogen-Oberlicht
 Fenêtre à deux vantaux avec imposte en arc bombé
 Double leaf window segmental arched top light

Profilübersicht

Sommaire des profilés

Summary of profiles

Jansen-Economy 50 Fenster

Jansen-Economy 50 fenêtres

Jansen-Economy 50 windows

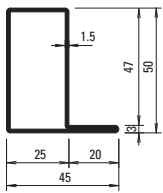

01.534
01.534 Z
01.534.01*
01.534.03*
01.534.05*
01.534.07*

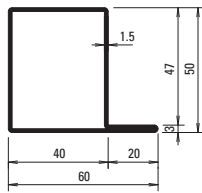

01.564
01.564 Z
01.564.01*
01.564.03*
01.564.05*
01.564.07*

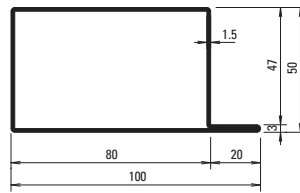

01.592
01.592 Z

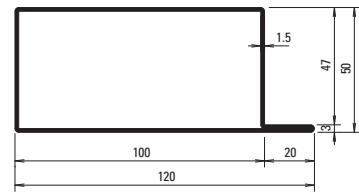

01.596
01.596 Z

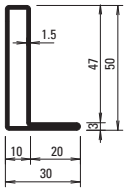

01.531
01.531 Z

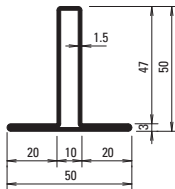

02.531
02.531 Z

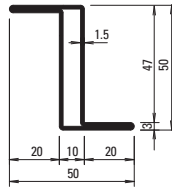

03.531
03.531 GV+GC

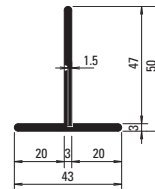

400.023
400.023 Z

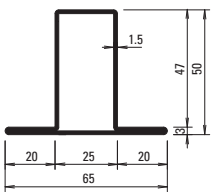

02.534
02.534 Z
02.534.01*
02.534.03*
02.534.05*
02.534.07*

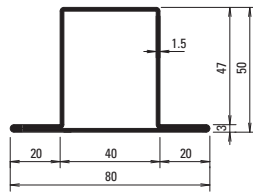

02.564
02.564 Z
02.564.01*
02.564.03*
02.564.05*
02.564.07*

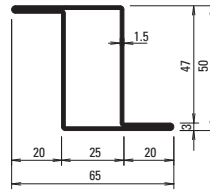

03.534
03.534 Z
03.534.01*
03.534.03*
03.534.05*
03.534.07*

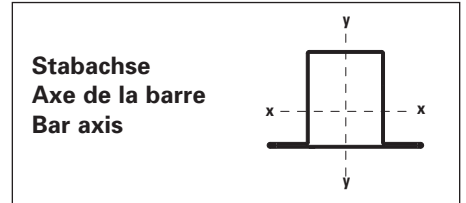

Profil-Nr.	G kg/m	F cm ²	I _x cm ⁴	W _x cm ³	I _y cm ⁴	W _y cm ³	U m ² /m
01.534	2,130	2,71	9,35	3,11	4,78	1,73	0,185
02.534	2,590	3,30	10,99	3,30	8,56	2,63	0,224
03.534	2,590	3,30	13,28	5,13	8,56	2,63	0,224
01.564	2,490	3,17	12,10	4,12	11,20	3,25	0,216
02.564	2,950	3,75	13,90	4,31	17,60	4,40	0,255
01.592	3,430	4,37	19,35	6,86	46,90	8,80	0,296
01.596	3,900	4,97	22,93	8,25	77,23	12,30	0,336

Profil-Nr.	G kg/m	F cm ²	I _x cm ⁴	W _x cm ³	I _y cm ⁴	W _y cm ³	U m ² /m
01.531	1,770	2,26	6,55	2,11	1,42	0,67	0,155
02.531	2,240	2,86	8,00	2,31	3,26	1,30	0,195
03.531	2,240	2,85	10,63	4,25	3,25	1,30	0,194
400.023	2,060	2,62	6,63	1,87	1,91	0,88	0,182
02.636	2,450	3,11	12,10	3,04	3,30	1,32	0,212
05.568	3,620	4,65	20,62	7,37	32,39	6,55	0,315
30.900	3,100	3,98	19,29	6,20	8,36	2,64	0,269
30.901	3,010	3,86	16,42	4,37	8,92	2,63	0,262
400.048	2,050	2,58	9,46	3,78	6,70	3,35	0,177

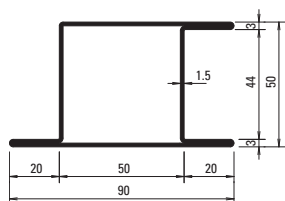

05.568
05.568 Z
 05.568.01*
 05.568.03*
 05.568.05*
 05.568.07*

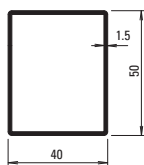

400.048
400.048 GV+GC

* Gewichte für Edelstahl-Profile
 * Poids pour profilés en acier Inox
 * Weights for stainless steel profiles

01.534.01 = 2,153 kg/m
02.534.01 = 2,622 kg/m
01.564.01 = 2,513 kg/m
02.564.01 = 2,975 kg/m
03.534.01 = 2,622 kg/m
05.568.01 = 3,672 kg/m
30.900.01 = 3,120 kg/m

01.534.05 = 2,126 kg/m
02.534.05 = 2,590 kg/m
01.564.05 = 2,481 kg/m
02.564.05 = 2,938 kg/m
03.534.05 = 2,590 kg/m
05.568.05 = 3,640 kg/m
30.900.05 = 3,081 kg/m

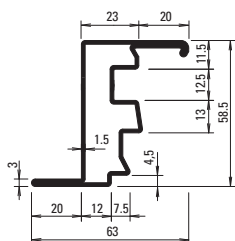

30.900
30.900 Z
 30.900.01*
 30.900.03*
 30.900.05*
 30.900.07*

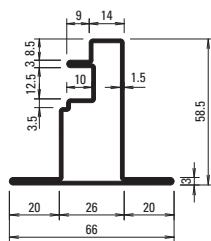

30.901
30.901 GV+GC

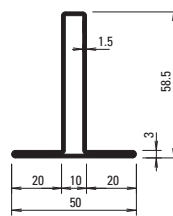

02.636
02.636 GV+GC

Artikelbibliothek
 Bibliothèque des articles
 Article library

DXF **DWG**

Oberfläche/Werkstoff

Artikel-Nr.
ohne Zusatz = blank
mit Z = Bandverzinkter Stahl
mit GV+GC = aussen galvanisch verzinkt und gelbchromatiert
mit 01 = Edelstahl, blank
 Werkstoff 1.4404 (AISI 316L)
mit 03 = Edelstahl geschliffen
 Korn 220-240
 Werkstoff 1.4404 (AISI 316L)
mit 05 = Edelstahl, blank
 Werkstoff 1.4307 (AISI 304L)
mit 07 = Edelstahl geschliffen
 Korn 220-240
 Werkstoff 1.4307 (AISI 304L)

Surface/Matériau

No. d'article
sans supplément = brut
avec Z = en bandes d'acier zinguées au feu
avec GV+GC = zingués galvanique à l'extérieur et chromatisé jaune
avec 01 = Acier Inox, brut
 matériau 1.4404 (AISI 316L)
avec 03 = Acier Inox, polies
 grain 220-240
 matériau 1.4404 (AISI 316L)
avec 05 = Acier Inox, brut
 matériau 1.4307 (AISI 304L)
avec 07 = Acier Inox, polies
 grain 220-240
 matériau 1.4307 (AISI 304L)

Surface/Material

Part no.
without addition = bright
with Z = made from hot-dip galvanised strip
with GV+GC = outside galvanised and yellow chromated
with 01 = Stainless steel, bright
 material 1.4404 (AISI 316L)
with 03 = Stainless steel
 polished, grain 220-240
 material 1.4404 (AISI 316L)
with 05 = Stainless steel, bright
 material 1.4307 (AISI 304L)
with 07 = Stainless steel
 polished, grain 220-240
 material 1.4307 (AISI 304L)

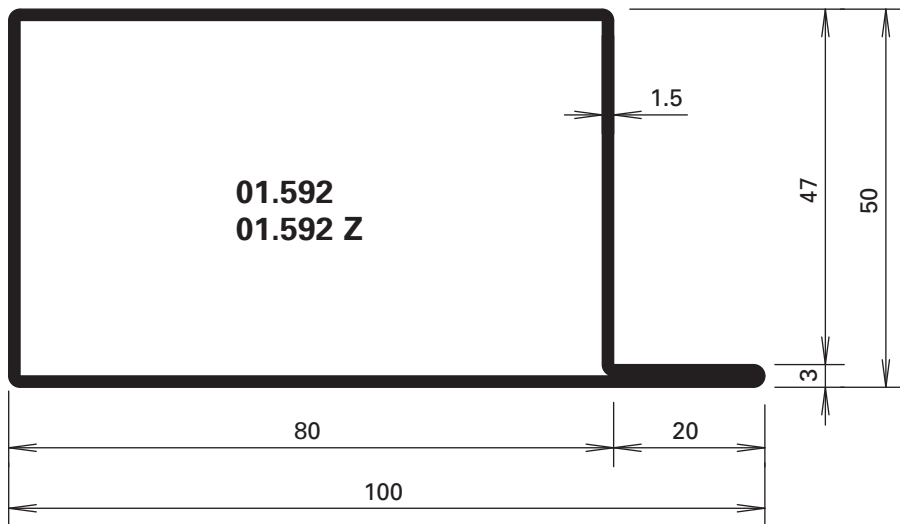
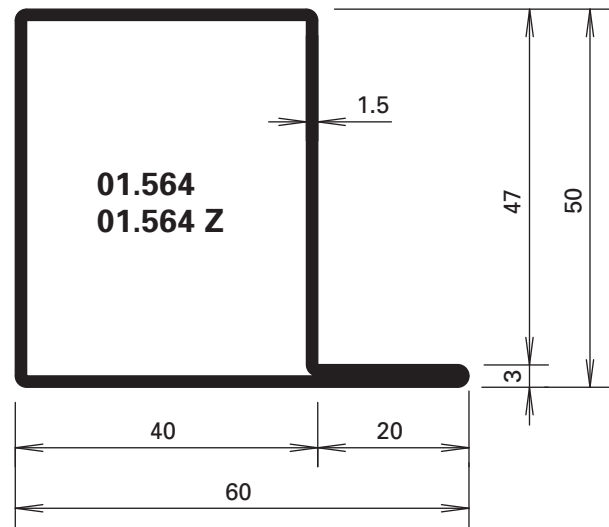
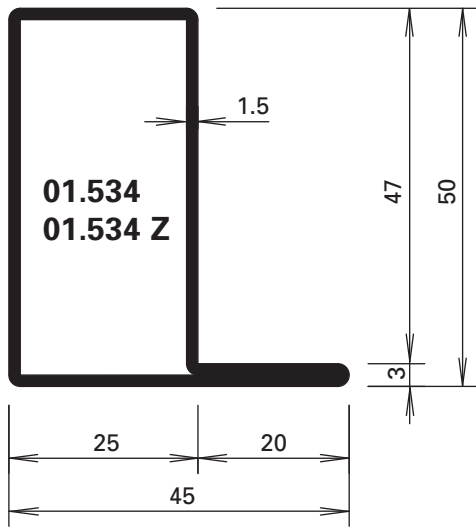

Z = Bandverzinkter Stahl, leicht eingeölt (Zinkauflage von 275 g/m² beidseitig = ca. 20 µm innen und aussen)

Z = Bandes d'acier zinguées au feu, légèrement huilées (couche de zinc 275 g/m² à deux côtés = env. 20 µm à l'intérieur et à l'extérieur)

Z = Hot-dip galvanised strip, lightly oiled (Zinc coating 275 g/m² approx. 20 µm inside and outside)

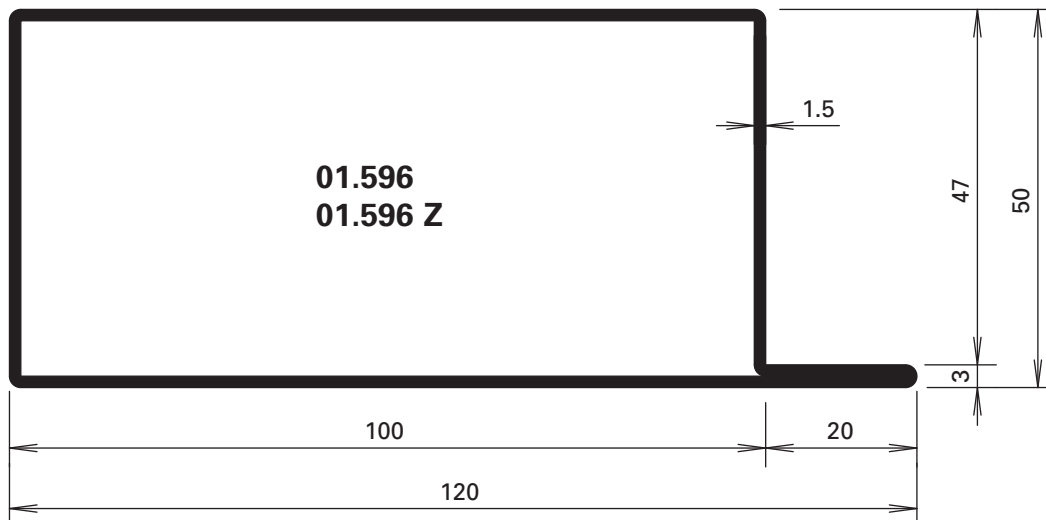

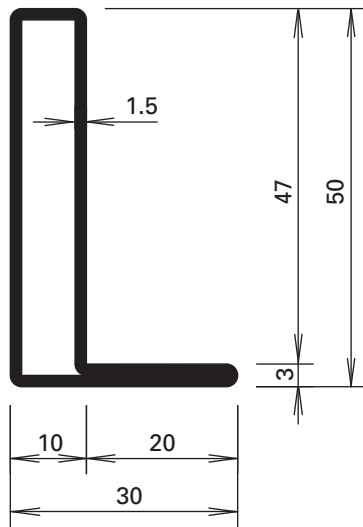

01.531
01.531 Z

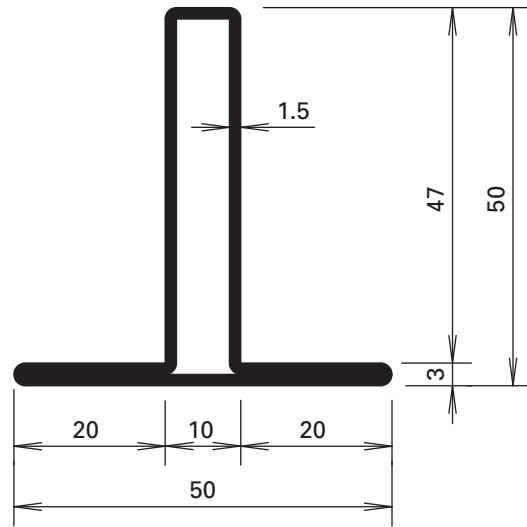

02.531
02.531 Z

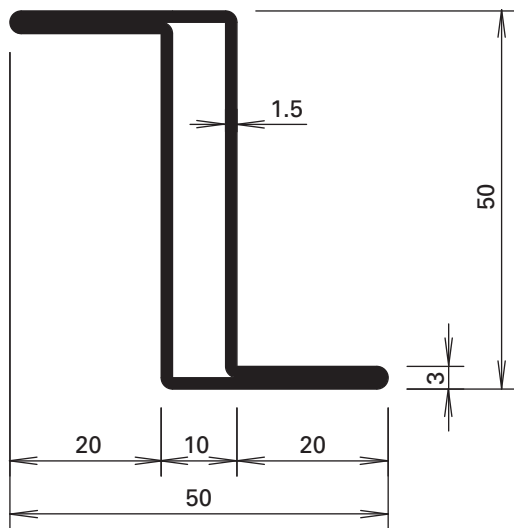

03.531
03.531 GV+GC

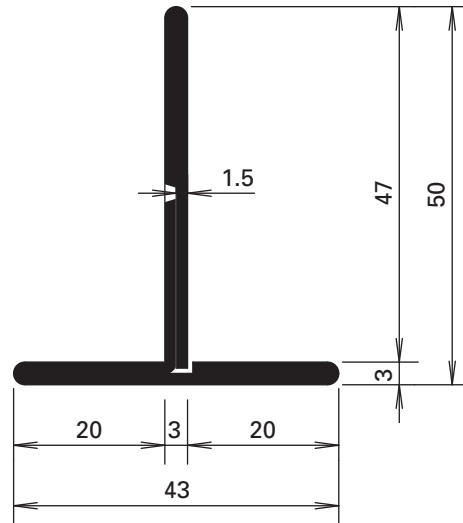

400.023
400.023 Z

GV+GC = aussen galvanisch verzinkt ca. 15 µm
 und gelbchromatiert

GV+GC = zingués galvanique env. 15 µm
 à l'extérieur et chromatisé jaune

GV+GC = outside galvanised approx. 15 µm
 and yellow chromated

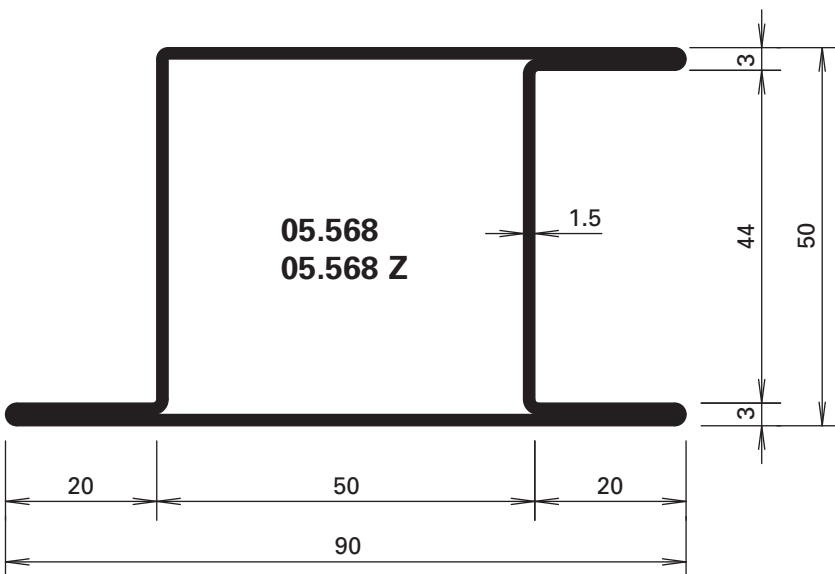
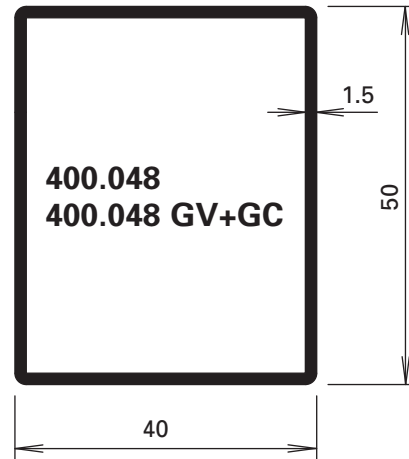
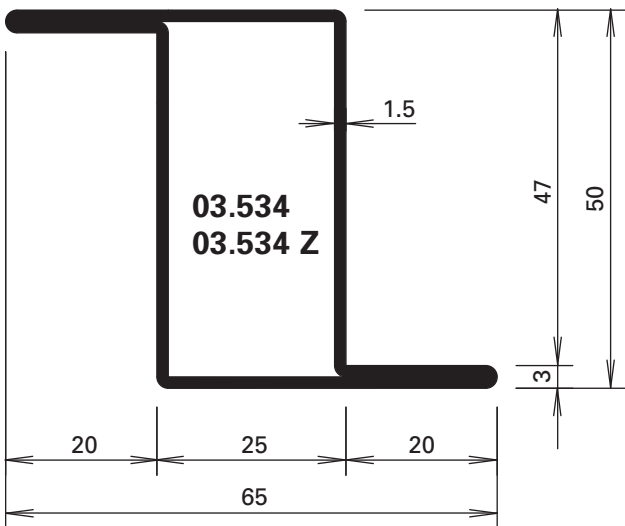
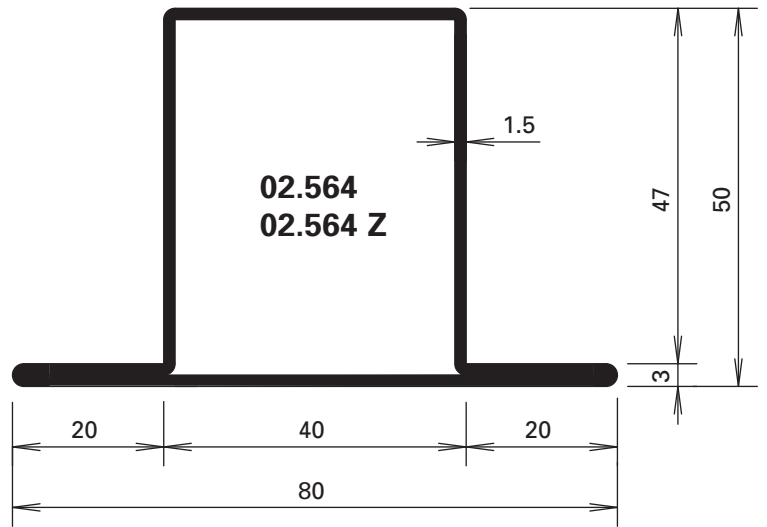
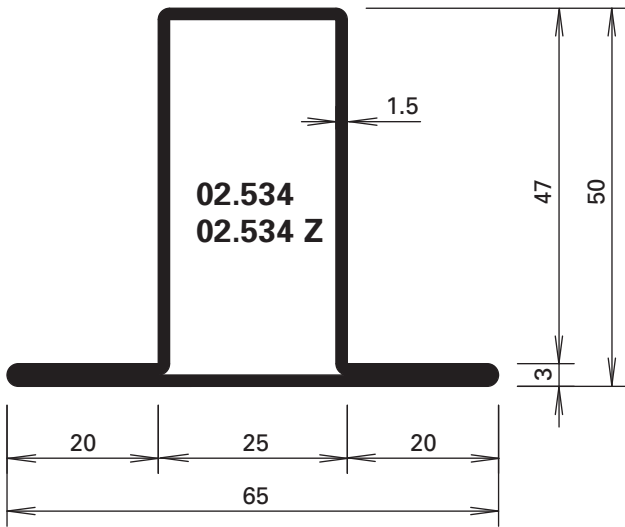

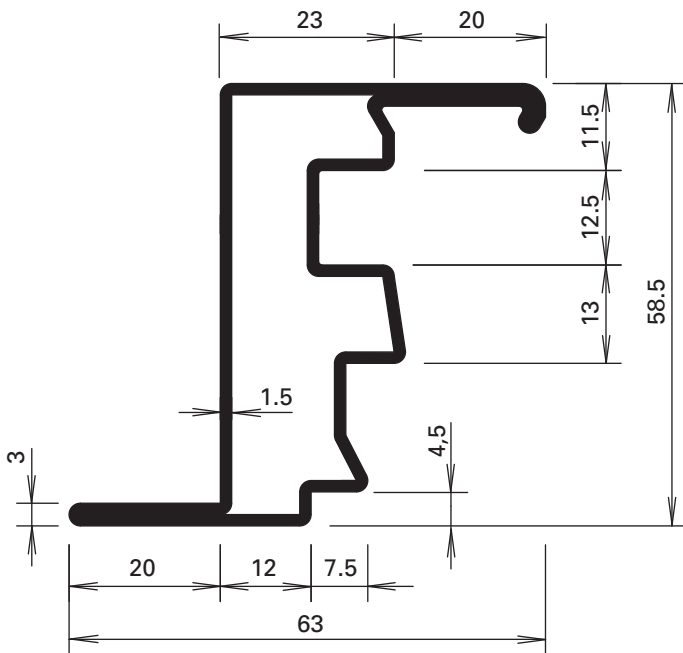

30.900
30.900 Z

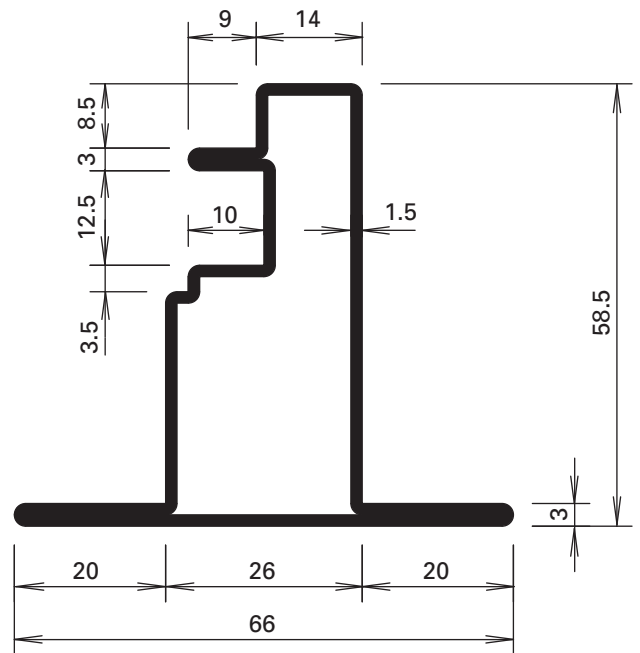

30.901
30.901 GV+GC

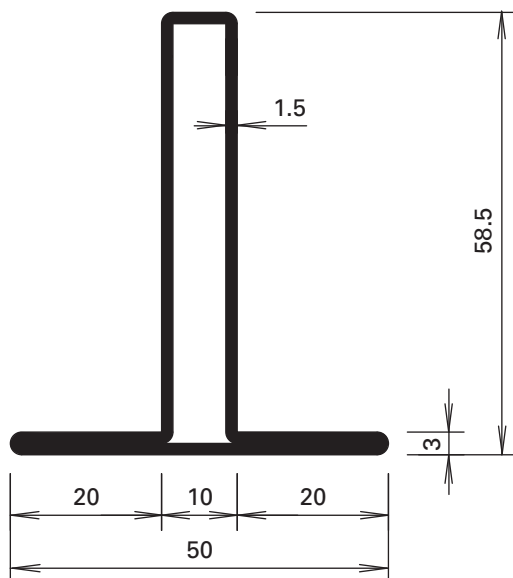

02.636
02.636 GV+GC

GV+GC = aussen galvanisch verzinkt ca. 15 µm und gelbchromatiert
 GV+GC = zingués galvanique env. 15 µm à l'extérieur et chromatisé jaune
 GV+GC = outside galvanised approx. 15 µm and yellow chromated

Z = Bandverzinkter Stahl, leicht eingeölt (Zinkauflage von 275 g/m² beidseitig = ca. 20 µm innen und aussen)

Z = Bandes d'acier zinguées au feu, légèrement huilées (couche de zinc 275 g/m² à deux côtés = env. 20 µm à l'intérieur et à l'extérieur)

Z = Hot-dip galvanised strip, lightly oiled (Zinc coating 275 g/m² approx. 20 µm inside and outside)

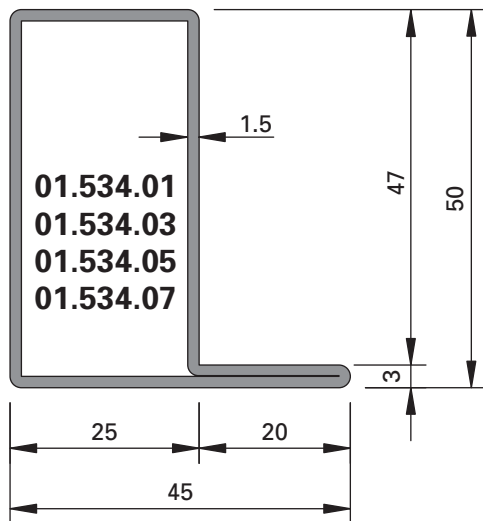

- 01 = Material:
 Edelstahl, Werkstoff 1.4404 (AISI 316L)
 Oberfläche: **blank**
- 03 = Material:
 Edelstahl, Werkstoff 1.4404 (AISI 316L)
 Oberfläche: **geschliffen**, Korn 220-240
- 05 = Material:
 Edelstahl, Werkstoff 1.4307 (AISI 304L)
 Oberfläche: **blank**
- 07 = Material:
 Edelstahl, Werkstoff 1.4307 (AISI 304L)
 Oberfläche: **geschliffen**, Korn 220-240

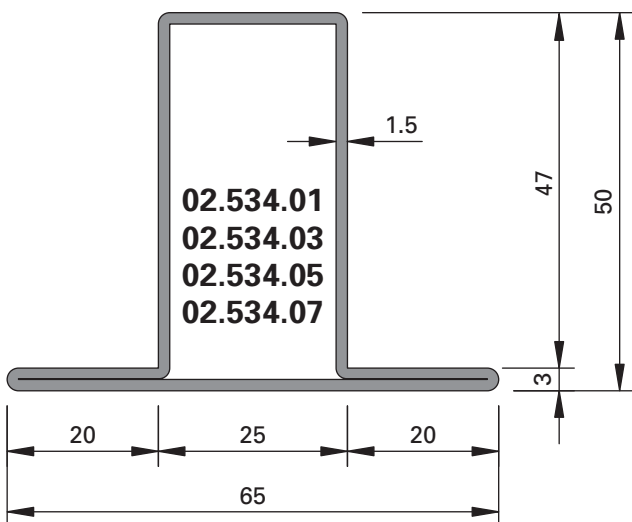

- 01 = Matériau:
 Acier inox, matériau 1.4404 (AISI 316L)
 Surface: **Brut**
- 03 = Matériau:
 Acier inox, matériau 1.4404 (AISI 316L)
 Surface: **polies**, grain 220-240
- 05 = Matériau:
 Acier inox, matériau 1.4307 (AISI 304L)
 Surface: **Brut**
- 07 = Matériau:
 Acier inox, matériau 1.4307 (AISI 304L)
 Surface: **polies**, grain 220-240

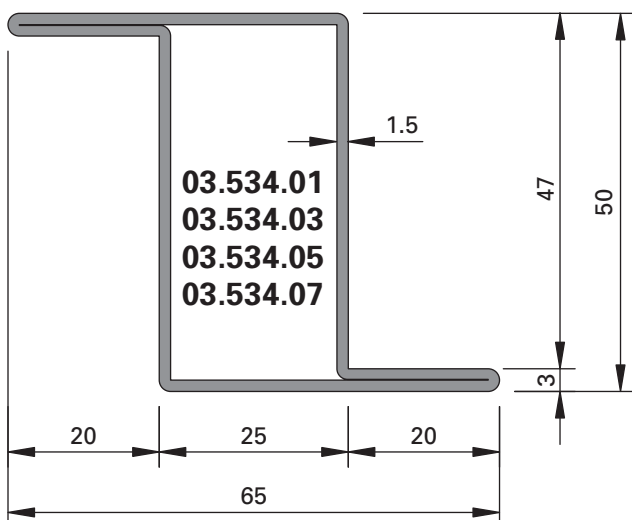

- 01 = Material:
 Stainless steel, material 1.4404 (AISI 316L)
 Surface: **bright**
- 03 = Material:
 Stainless steel, material 1.4404 (AISI 316L)
 Surface: **polished**, grain 220-240
- 05 = Material:
 Stainless steel, material 1.4307 (AISI 304L)
 Surface: **bright**
- 07 = Material:
 Stainless steel, material 1.4307 (AISI 304L)
 Surface: **polished**, grain 220-240

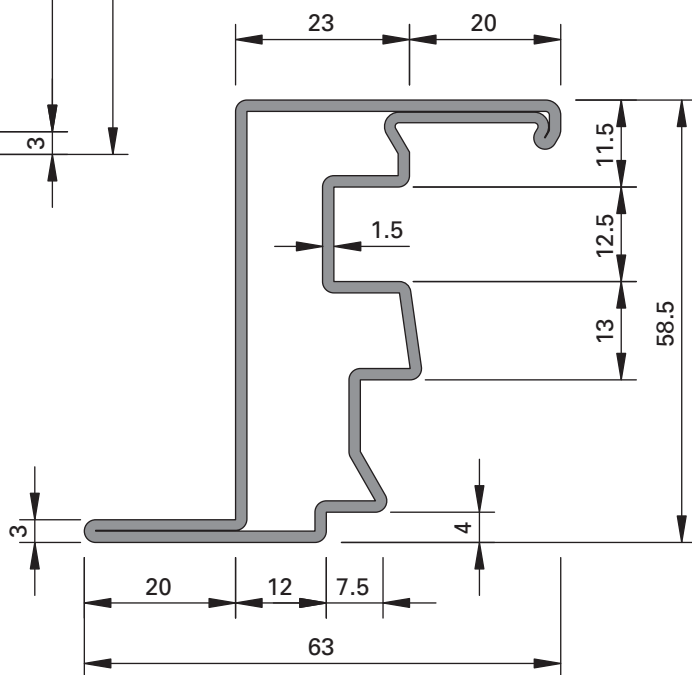
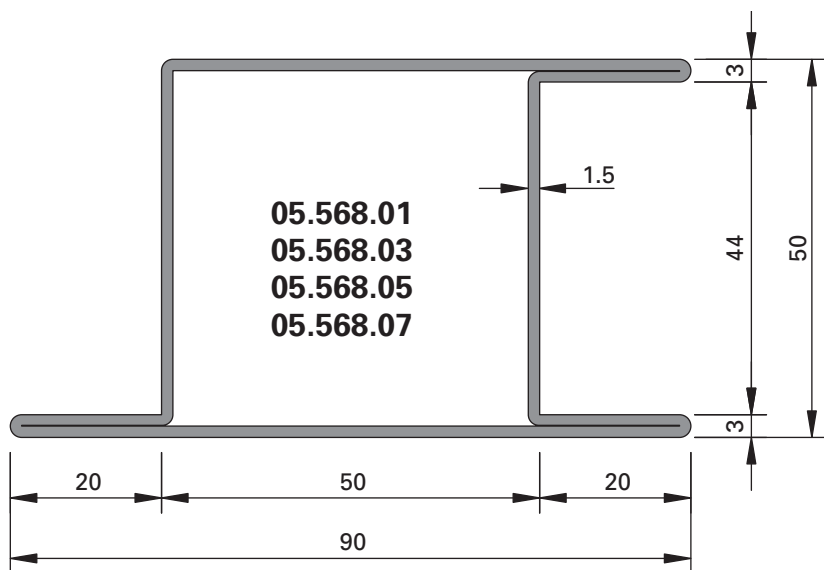
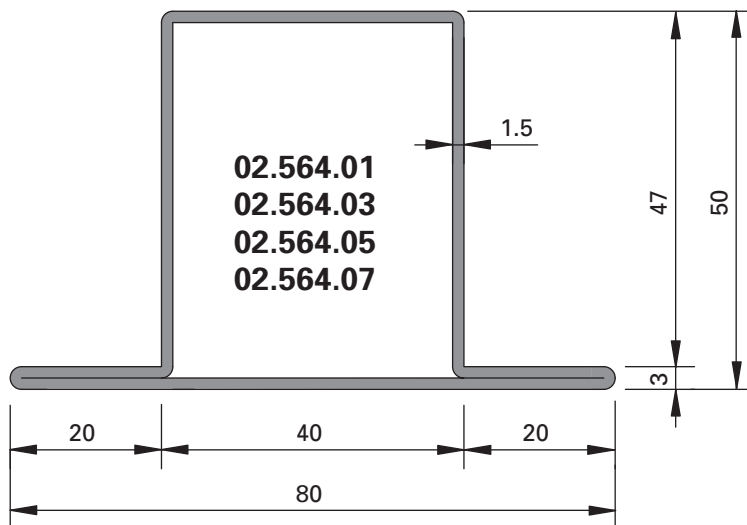
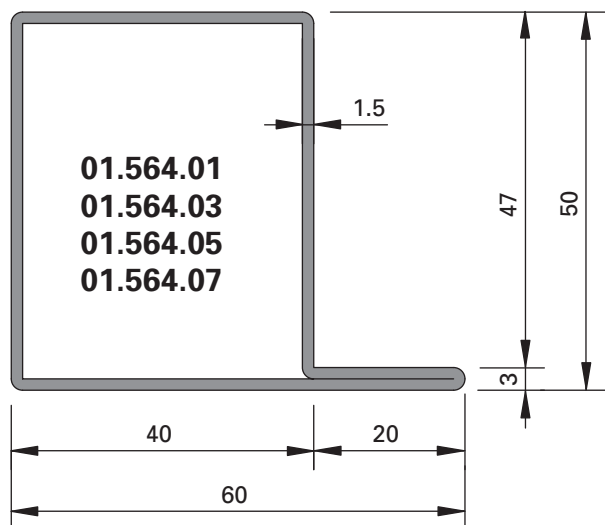

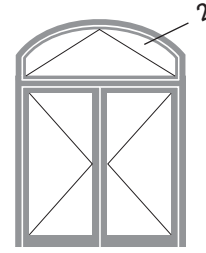
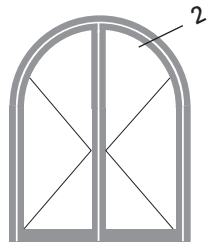
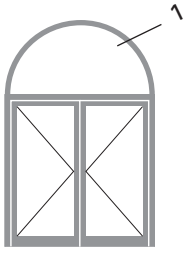

1.0

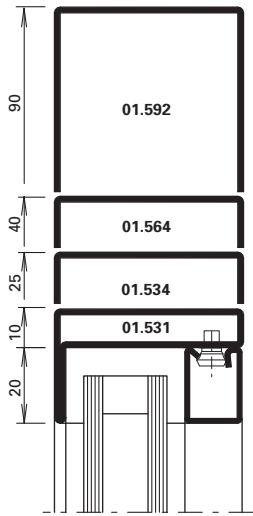

1.1

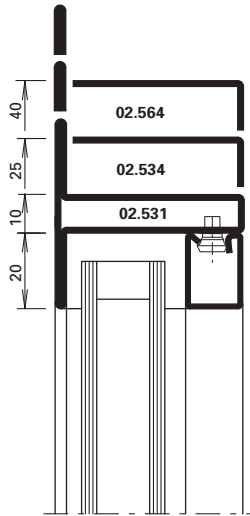

2.0

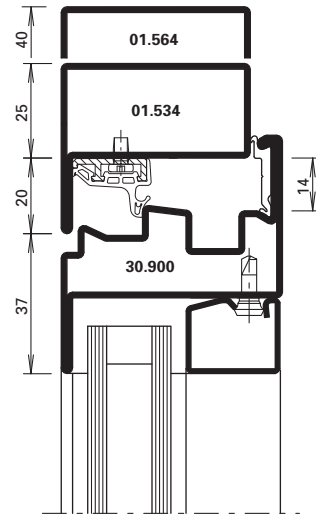

Halbrundbogen
 Arc semi-circulaire
 Semi-circular arch

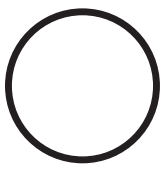

Rundbogen
 Arc en plein centre
 Round arch

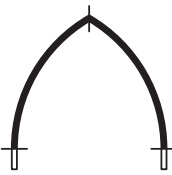

Spitzbogen
 Ogive
 Gothic arch



Stichbogen
 Arc bombé
 Segmented arch



Korbbogen
 Anse de panier
 Oval arch

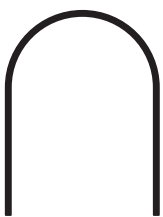

Halbrundbogen mit Schenkel
 Arc surhaussé
 Semi-circular arch with side extension

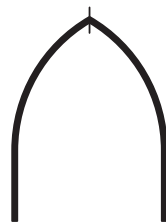

Spitzbogen mit Schenkel
 Arc en ogive
 Gothic arch with side extension

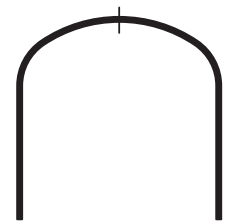



Korbbogen mit Schenkel
 Anse de panier prolongée
 Oval arch with side extension

Bogenfenster
Fenêtres cintrées
Arched windows

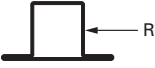
Jansen-Economy 50 Fenster
 Jansen-Economy 50 fenêtres
 Jansen-Economy 50 windows

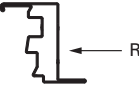
Profil Profilé Profile	Min. Radius Rayon min. Min. radius R	blank brut bright	verzinkt zinguées galvanised
		mm	mm
01.531	350		
01.534	400	800	
01.564	600	1000	
01.592	1000		
02.531	350	600	
02.534	400	800	
02.564	600	1000	
03.531	600		
03.534	500	800	
05.568	800	1200	
400.023		800	

			
30.900	550		

			
400.048*	500	500	

* GV+GC

Stahl-Glasleisten Parcloses en acier Steel glazing beads	Min. Radius Rayon min. Min. radius R
	
402.112 Z	650 mm
402.115 Z	500 mm
402.120 Z	600 mm
402.125 Z	750 mm
402.130 Z	800 mm
402.135 Z	1500 mm

Stahl-Glasleisten Parcloses en acier Steel glazing beads	Min. Radius Rayon min. Min. radius R
	
62.507 GV+GC	400 mm
62.508 GV+GC	500 mm
62.509 GV+GC	600 mm

Aluminium-Glasleisten Parcloses en aluminium Aluminium glazing beads	Min. Radius Rayon min. Min. radius R
	
404.109	400 mm
404.112	400 mm
404.115	400 mm
404.116	400 mm
404.119	400 mm
404.120	400 mm
404.125	400 mm
404.129	900 mm
404.130	500 mm
404.135	500 mm

	
405.103	500 mm
405.106	500 mm
405.110	500 mm
405.115	500 mm
405.120	500 mm
405.125	800 mm
405.130	1000 mm
405.135	1000 mm
406.903	500 mm
406.905	500 mm
406.907	500 mm
406.909	650 mm

Biegen von Edelstahl-Profilen auf Anfrage!

Die Radien-Angaben beziehen sich auf die langjährige Erfahrung und Fertigung im Hause Jansen.

Profilés acier Inox sur demande!

Les rayons indiqués se fondent sur la longue expérience et la fabrication au sein de la maison Jansen.

Stainless steel profiles on request!

The radii specifications are based on the many years of experience Jansen has in fabrication.

Glasleisten (Massstab 1:2)

Parcloses (échelle 1:2)

Glazing beads (scale 1:2)

Jansen-Economy 50 Fenster
Jansen-Economy 50 fenêtres
Jansen-Economy 50 windows

Stahl-Glasleisten aus bandverzinktem Stahl (Länge 6 m)

Parcloses en acier en bandes d'acier zinguées au feu (longueur 6 m)

Steel glazing beads made of hot-dip galvanised strip (length 6 m)

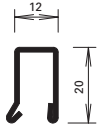

402.112 Z

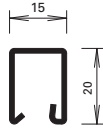

402.115 Z

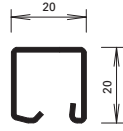

402.120 Z

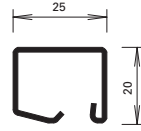

402.125 Z

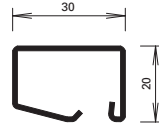

402.130 Z

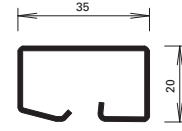

402.135 Z

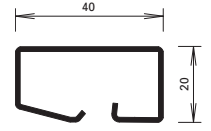

402.140 Z



450.007

Befestigungsknopf

VE = 50 Magazine à 10 Knöpfe

Bouton de fixation

UV = 50 magasins à 10 pièces

Fastening stud

PU = 50 magazines with 10 studs



450.008

Befestigungsknopf

VE = 400 Magazine à 10 Knöpfe

Bouton de fixation

UV = 400 magasins à 10 pièces

Fastening stud

PU = 400 magazines with 10 studs



450.006

Befestigungsknopf (kurz) SR1

Bohrdurchmesser \varnothing 3,5 mm

VE = 100 Stück

Bouton de fixation (court) SR1

Diamètre de perçage \varnothing 3,5 mm

UV = 100 pièces

Fastening stud (short) SR1

Hole diameter \varnothing 3,5 mm

PU = 100 pieces

Winkelkontur-Stahl-Glasleisten (Länge ca. 6 m)

Parcloses en acier à contour angulaire (longueur env. 6 m)

Angle contour steel glazing beads (length approx. 6 m)

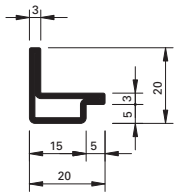

62.507 GV+GC

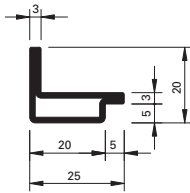

62.508 GV+GC

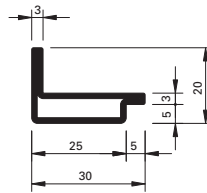

62.509 GV+GC

GV+GC = aussen galvanisch verzinkt
ca. 15 μ m und
gelbchromatiert
(EN 12329 – Fe//Zn15//C)

GV+GC = zingués galvanique
env. 15 μ m à l'extérieur
et chromatisé jaune
(EN 12329 – Fe//Zn15//C)

GV+GC = outside galvanised
approx. 15 μ m and
yellow chromated
(EN 12329 – Fe//Zn15//C)

Artikelbibliothek
Bibliothèque des articles
Article library

DXF

DWG

Aluminium-Glasleisten
 (Länge 6 m)

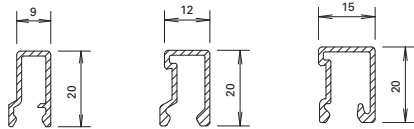

404.109** 404.112 404.115

Parcloses en aluminium
 (longueur 6 m)

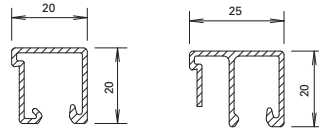

404.120 404.125 404.130

Aluminium glazing beads
 (length 6 m)

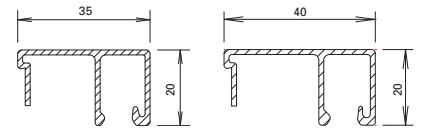

404.135 404.140

 **450.007**
Befestigungsknopf
 VE = 50 Magazine à 10 Knöpfe
Bouton de fixation
 UV = 50 magasins à 10 pièces
Fastening stud
 PU = 50 magazines with 10 studs

 **450.008**
Befestigungsknopf
 VE = 400 Magazine à 10 Knöpfe
Bouton de fixation
 UV = 400 magasins à 10 pièces
Fastening stud
 PU = 400 magazines with 10 studs

 **450.006**
Befestigungsknopf (kurz) SR1
 Bohrdurchmesser \varnothing 3,5 mm
 VE = 100 Stück
Bouton de fixation (court) SR1
 Diamètre de perçage \varnothing 3,5 mm
 UV = 100 pièces
Fastening stud (short) SR1
 Hole diameter \varnothing 3,5 mm
 PU = 100 pieces

** nur für Paneele geeignet
 ** uniquement pour panneaux
 ** only suitable for panels

Aluminium-Glasleisten
 (Länge 6 m)

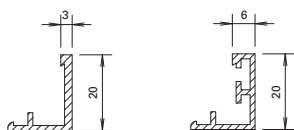

405.103 405.106

Parcloses en aluminium
 (longueur 6 m)

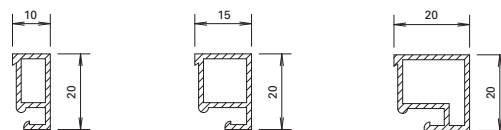

405.110 405.115 405.120

Aluminium glazing beads
 (length 6 m)

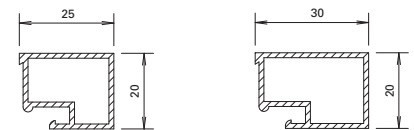

405.125 405.130

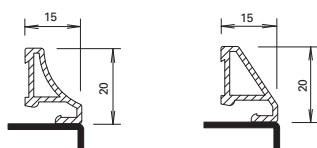

406.905 406.907

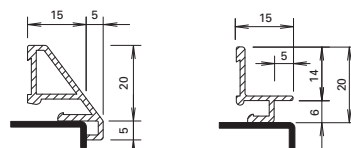

406.901 406.903

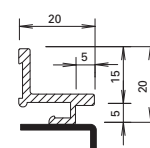

406.909 406.996

 **450.022**
Befestigungsfeder
 Edelstahl, inkl. Schraube,
 Bohrdurchmesser \varnothing 3,5 mm
 VE = 100 Stück
Ressort de fixation
 acier Inox, vis inclus,
 diamètre de perçage \varnothing 3,5 mm
 UV = 100 pièces
Fixing spring
 stainless steel, incl. screw,
 hole diameter \varnothing 3,5 mm
 PU = 100 pieces

 **450.020**
Befestigungsknopf
 Kunststoff
 VE = 100 Stück
Bouton de fixation
 matière plastique
 UV = 100 pièces
Fastening stud
 plastic
 PU = 100 pieces

 **450.021**
Schraube M3x12
 Stahl verzinkt,
 Bohrdurchmesser \varnothing 2,8 mm
 VE = 100 Stück
Vis M3x12
 acier zingué,
 diamètre de perçage \varnothing 2,8 mm
 UV = 100 pièces
Screw M3x12
 galvanised steel,
 hole diameter \varnothing 2,8 mm
 PU = 100 pieces

Glasleisten (Massstab 1:2)
Parcloses (échelle 1:2)
Glazing beads (scale 1:2)

Jansen-Economy 50 Fenster
 Jansen-Economy 50 fenêtres
 Jansen-Economy 50 windows

Edelstahl-Glasleisten
(1.4401 / 1.4301)
Länge 6 m

Parcloses en acier Inox
(AISI 316 / AISI 304)
Longueur 6 m

Stainless steel glazing beads
(AISI 316 / AISI 304)
Length 6 m

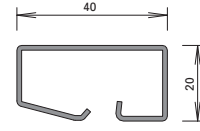
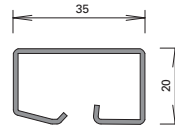
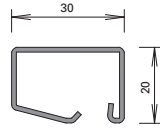
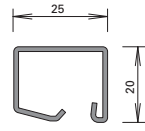
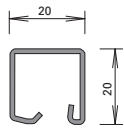
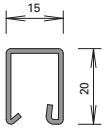

402.515
402.515.03
 402.415
 402.415.07

402.520
402.520.03
 402.420
 402.420.07

402.525
402.525.03
 402.425
 402.425.07

402.530
402.530.03
 402.430
 402.430.07

402.535
402.535.03

402.540
402.540.03

Oberfläche:
03/07: geschliffen, Korn 220

Surface:
03/07: polies, grain 220

Surface:
03/07: polished, grain 220



450.025

Befestigungsknopf
 Edelstahl, gewindeformend,
 mit SR1-Angriff,
 Bohrdurchmesser 3,5 mm
 VE = 100 Stück

450.025

Bouton de fixation
 en acier inox, formant le taraudage,
 avec empreinte SR1,
 diamètre de perçage 3,5 mm
 UV = 100 pièces

450.025

Fastening stud
 stainless steel, self-tapping,
 with SR1 head,
 hole diameter 3,5 mm
 PU = 100 pieces



499.001

Befestigungsset
 zum Versetzen der
 magazinierten Befestigungs-
 Knöpfe 450.007/008

VE = 1 Set komplett inkl. Koffer
 3 Kreuzschlitz-
 Schraubklingen

499.001

**Machine à poser les boutons
 de parcloses**
 pour le déplacement des
 boutons de fixations 450.007/008
 emmagasinés

UV = 1 set complet, valise incl.
 3 mèches cruciforme

499.001

Fastening set
 for placing magazine fixing
 studs 450.007/008

PU = 1 set complete, incl. case
 3 Phillips screwdriver
 blades

Artikelbibliothek
 Bibliothèque des articles
 Article library

DXF

DWG

Glasleisten
Parcloses
Glazing beads

Jansen-Economy 50 Fenster
 Jansen-Economy 50 fenêtres
 Jansen-Economy 50 windows

Artikel-Nr.	G kg/m	B m ² /m
402.112 Z	0,550	0,062
402.115 Z	0,600	0,066
402.120 Z	0,670	0,074
402.125 Z	0,740	0,083
402.130 Z	0,844	0,092
402.135 Z	0,960	0,103
402.140 Z	1,045	0,112

Artikel-Nr.	G kg/m	U m ² /m	P m ² /m
404.109	0,180	0,102	0,029
404.112	0,202	0,110	0,032
404.115	0,226	0,117	0,035
404.120	0,252	0,148	0,040
404.125	0,310	0,178	0,045
404.130	0,330	0,188	0,050
404.135	0,350	0,198	0,055
404.140	0,370	0,208	0,060

Artikel-Nr.	G kg/m	U m ² /m	P m ² /m
405.103	0,197	0,082	0,023
405.106	0,212	0,109	0,026
405.110	0,204	0,074	0,030
405.115	0,240	0,084	0,035
405.120	0,295	0,093	0,040
405.125	0,330	0,103	0,045
405.130	0,365	0,113	0,050
406.901	0,280	0,104	0,040
406.903	0,157	0,082	0,039
406.905	0,211	0,075	0,029
406.907	0,217	0,075	0,029
406.909	0,252	0,094	0,045
406.996	0,246	0,119	0,039

Artikel-Nr.	G kg/m	P m ² /m
402.515 / 415	0,590	0,035
402.520 / 420	0,680	0,040
402.525 / 425	0,760	0,045
402.530 / 430	0,850	0,050
402.535	0,960	0,055
402.540	1,060	0,060

Artikel-Nr.	G kg/m	B m ² /m
62.507	0,840	0,076
62.508	0,960	0,086
62.509	1,090	0,096

G = Gewicht
 B = Beschichtungsfläche
 U = Abwicklung umlaufend
 P = Polierabwicklung

G = Poids
 B = Surface à traiter
 U = Périmètre extérieur
 P = Périmètre à polir

G = Weight
 B = Coated surface
 U = Circumferential development
 P = Circumferential polishing

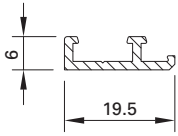

407.120

Aluminium-Zusatzprofil
für Mitteldichtung 455.441,
0,130 kg/m
U = 0,066 m²/m
Einbau mit Schraube 555.486

Länge 6 m

407.120

**Profilé complémentaire
en aluminium**
pour joint médian 455.441
0,130 kg/m
U = 0,066 m²/m
Montage avec vis 555.486

Longueur 6 m

407.120

Additional profile, aluminium
for central weatherstrip 455.441
0,130 kg/m
U = 0,066 m²/m
Installation with screw 555.486

Length 6 m

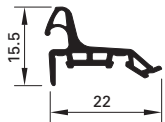

455.441

Mitteldichtung
EPDM, schwarz, zum
Aufstecken auf das Aluminium-
Zusatzprofil 407.120

VE = 100 m

455.441

Joint médian
EPDM, noir, à ficher sur le
profilé supplémentaire en
aluminium 407.120

UV = 100 m

455.441

Central weatherstrip
EPDM, black, for attaching to
the aluminium supplementary
profile 407.120

PU = 100 m



455.442

Dichtungsecken
vulkanisiert, EPDM, schwarz,
für Dichtung 455.441,
Schenkellänge ca. 55 mm

VE = 4 Stück

455.442

Joint d'angles
vulcanisés, EPDM, noir,
pour joint 455.441,
longueur env. 55 mm

UV = 4 pièces

455.442

Weatherstrip corners
vulcanised, EPDM, black,
for weatherstrip 455.441,
length approx. 55 mm per side

PU = 4 pieces



455.410

Anschlagdichtung
EPDM, schwarz

VE = 100 m

455.410

Joint de butée
EPDM, noir

UV = 100 m

455.410

Rebate weatherstrip
EPDM, black

PU = 100 m

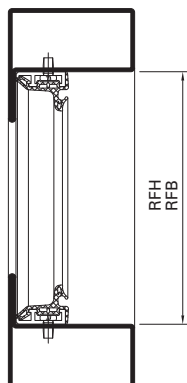

455.444

Dichtungsrahmen
EPDM. Über Sonderbe-
stellung (ab 10 VE) liefern wir
vulkanisierte Dichtungsrahmen
der Mitteldichtung 455.441

Mit Ihrer Bestellung benötigen
wir folgende Angaben:

- Anzahl Rahmen
- RFB in mm
- RFH in mm

455.444

Cadres vulcanisés
EPDM. Sur commande
spéciale (dès 10 UV), nous
livrons des cadres vulcanisés
du joint médian 455.441

Votre commande devrait
contenir:

- Nombre de cadre
- RFB en mm
- RFH en mm

455.444

Weatherstrip frame
EPDM. By special order
(from 10 PU), we also supply
vulcanised weatherstrip frames
made from the central
weatherstrip 455.441

With your order,
please state:

- Number of frames
- RFB in mm
- RFH in mm



455.443

Stulpdichtung

EPDM, schwarz, für unteren und oberen Abschluss der Mitteldichtung 455.441 im Stulpbereich

VE = 1 Paar (links und rechts)

455.443

Embout deux-vantaux

EPDM, noir, pour les terminaisons inférieure et supérieure du joint médian 455.441

UV = 1 pair (gauche et droite)

455.443

Double-vent weatherstrip

EPDM, black, for attaching the centre weatherstrip 455.441 at the top and bottom in the meeting stile area

PU = 1 pair (left and right)



455.404

Stulpblende

Kunststoff schwarz, als Abschlussstück im Stulpbereich

Einbau mit Anschlagdichtung 455.410

VE = 1 Paar

455.404

Cache deux-vantaux

matière plastique noire, comme pièce de terminaison dans la zone de battement

Montage avec joint de butée 455.410

UV = 1 paire

455.404

Double-casement window facing

plastic, black, as end closer in the meeting stile area

Installation with rebate weatherstrip 455.410

PU = 1 pair



555.486

Schraube M4x7

Stahl, Edelstahl-Look, SR1-Angriff, selbstgewindend, für die Befestigung der Aluminium-Zusatzprofile 407.120

Bohrdurchmesser 3,6 mm

VE = 100 Stück

555.486

Vis M4x7

acier, surface acier Inox, empreinte SR1, autotaraudeuse, pour fixer les profilés supplémentaires en aluminium 407.120

Diamètre de perçage 3,6 mm

UV = 100 pièces

555.486

Screw M4x7

steel, stainless steel surface, SR1 head, self-tapping, for fixing the aluminium additional profiles 407.120

Hole diameter 3.6 mm

PU = 100 pieces



450.047

Entwässerungstülle

Zink-Druckguss,
Bohrdurchmesser 12 mm

Einbau mit Bohrlehre 499.319,
Kegelsenker 499.339 und
Montagewerkzeug 499.318

VE = 50 Stück

450.047

Douille d'évacuation d'eau

fonte de zinc injectée,
diamètre de perçage 12 mm

Montage avec gabarit de perçage
499.319, fraise conique 499.339 et
outil de montage 499.318

UV = 50 pièces

450.047

Drain pipe

zinc diecasting,
drilling diameter 12 mm

Installation with drilling jig
499.319, countersink 499.339
and fitting tool 499.318

PU = 50 pieces



450.049

Entwässerungstülle

Edelstahl 1.4401,
Bohrdurchmesser 12 mm

Einbau mit Bohrlehre 499.319,
Kegelsenker 499.339 und
Montagewerkzeug 499.318

VE = 10 Stück

450.049

Douille d'évacuation d'eau

acier Inox qualité 1.4401,
diamètre de perçage 12 mm

Montage avec gabarit de
perçage 499.319, fraise 499.339
et outil de montage 499.318

UV = 10 pièces

450.049

Drain pipe

stainless steel 1.4401,
drilling diameter 12 mm

Installation with drilling jig
499.319, countersink 499.339
and fitting tool 499.318

PU = 10 pieces



450.055

Abdeckkappe

Kunststoff, schwarz, für die
Abdeckung der Entwässerungs-
tüllen 450.047/049

VE = 10 Stück

450.055

Capuchon

matière plastique, noire, pour
couvrir les douilles d'évacuation
d'eau 450.047/049

UV = 10 pièces

450.055

Cover caps

plastic, black, for covering
drain pipes 450.047/049

PU = 10 pieces



450.080

Entspannungsröhrchen

Kunststoff, schwarz, für die
verdecktliegende Glasfalz-
belüftung

VE = 10 Stück

450.080

Tubulure de décompression

matière plastique, noir, pour
l'aération de feuillure à verre
non apparente

UV = 10 pièces

450.080

Stress relieving tube

plastic, black, for the concealed
rebate ventilation

PU = 10 pieces

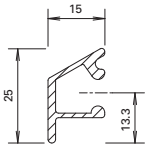

407.001

Aluminium-Wetterschenkel
roh, Gewicht 0,266 kg/m
U = 0,100 m²/m
P = 0,034 m²/m

Länge 6 m

Befestigungsknopf 450.006/007
Endstück 450.050

407.001

Renvoi d'eau en aluminium
brut, poids 0,266 kg/m
U = 0,100 m²/m
P = 0,034 m²/m

Longueur 6 m

Bouton de fixation 450.006/007
Embout 450.050

407.001

Aluminium weatherbar
mill finish, weight 0,266 kg/m
U = 0,100 m²/m
P = 0,034 m²/m

Length 6 m

Fixing stud 450.006/007
End piece 450.050

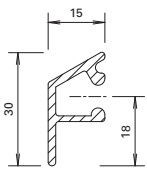

407.002

Aluminium-Wetterschenkel
roh, Gewicht 0,290 kg/m
U = 0,114 m²/m
P = 0,040 m²/m

Länge 6 m

Befestigungsknopf 450.006/007
Endstück 450.051

407.002

Renvoi d'eau en aluminium
brut, poids 0,290 kg/m
U = 0,114 m²/m
P = 0,040 m²/m

Longueur 6 m

Bouton de fixation 450.006/007
Embout 450.051

407.002

Aluminium weatherbar
mill finish, weight 0,290 kg/m
U = 0,114 m²/m
P = 0,040 m²/m

Length 6 m

Fixing stud 450.006/007
End piece 450.051

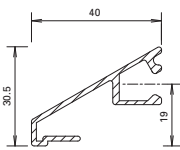

407.003

Aluminium-Wetterschenkel
roh, Gewicht 0,434 kg/m
U = 0,190 m²/m
P = 0,059 m²/m

Länge 6 m

Befestigungsknopf 450.006/007

407.003

Renvoi d'eau en aluminium
brut, poids 0,434 kg/m
U = 0,190 m²/m
P = 0,059 m²/m

Longueur 6 m

Bouton de fixation 450.006/007

407.003

Aluminium weatherbar
mill finish, weight 0,434 kg/m
U = 0,190 m²/m
P = 0,059 m²/m

Length 6 m

Fixing stud 450.006/007

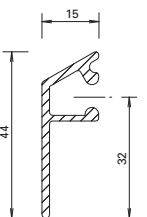

407.004

Aluminium-Wetterschenkel
roh, Gewicht 0,360 kg/m
U = 0,142 m²/m
P = 0,054 m²/m

Länge 6 m

Befestigungsknopf 450.006/007

407.004

Renvoi d'eau en aluminium
brut, poids 0,360 kg/m
U = 0,142 m²/m
P = 0,054 m²/m

Longueur 6 m

Bouton de fixation 450.006/007

407.004

Aluminium weatherbar
mill finish, weight 0,360 kg/m
U = 0,142 m²/m
P = 0,054 m²/m

Length 6 m

Fixing stud 450.006/007

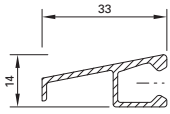

407.008

Aluminium-Wetterschenkel
roh, Gewicht 0,261 kg/m
U = 0,127 m²/m
P = 0,040 m²/m

Länge 6 m

Befestigungsknopf 450.006

407.008

Renvoi d'eau en aluminium
brut, poids 0,261 kg/m
U = 0,127 m²/m
P = 0,040 m²/m

Longueur 6 m

Bouton de fixation 450.006

407.008

Aluminium weatherbar
mill finish, weight 0,261 kg/m
U = 0,127 m²/m
P = 0,040 m²/m

Length 6 m

Fixing stud 450.006

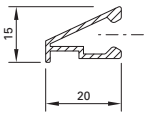

407.009

Aluminium-Wetterschenkel
roh, Gewicht 0,185 kg/m
U = 0,100 m²/m
P = 0,028 m²/m

Länge 6 m

Befestigungsknopf 450.006
Endstück 450.070

407.009

Renvoi d'eau en aluminium
brut, poids 0,185 kg/m
U = 0,100 m²/m
P = 0,028 m²/m

Longueur 6 m

Bouton de fixation 450.006
Embout 450.070

407.009

Aluminium weatherbar
mill finish, weight 0,185 kg/m
U = 0,100 m²/m
P = 0,028 m²/m

Length 6 m

Fixing stud 450.006
End piece 450.070

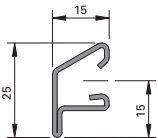

400.859

Edelstahl-Wetterschenkel
Werkstoff 1.4401 (AISI 316)
0,628 kg/m
P = 0,031 m²/m

Länge 6 m

Oberfläche:
walzblank, auf Wunsch
Sichtflächen geschliffen

Befestigungsknopf 450.025
Endstück 450.050

400.859

Renvoi d'eau en acier Inox
matériau 1.4401 (AISI 316)
0,628 kg/m
P = 0,031 m²/m

Longueur 6 m

Surface:
laminé brut, sur demande
surfaces visibles polies.

Bouton de fixation 450.025
Embout 450.050

400.859

Stainless steel weatherbar
material 1.4401 (AISI 316)
0,628 kg/m
P = 0,031 m²/m

Length 6 m

Surface:
Bright rolled, visual surfaces
polished on request

Fixing stud 450.025
End piece 450.050



450.050

Endstück
Kunststoff, schwarz, für
Wetterschenkel 407.001 und
400.859

VE = je 10 Stück
(links und rechts)

450.051

Endstück
Kunststoff, schwarz,
für Wetterschenkel 407.002

VE = je 10 Stück
(links und rechts)

450.050

Embout
matière plastique, noire,
pour renvoi d'eau 407.001 et
400.859

UV = 10 paires
(gauche et droite)

450.051

Embout
matière plastique, noire,
pour renvoi d'eau 407.002

UV = 10 paires
(gauche et droite)

450.050

End piece
plastic, black, for weatherbar
407.001 and 400.859

PU = 10 pieces each
(left and right)

450.051

End piece
black, plastic,
for weatherbar 407.002

PU = 10 pieces each
(left and right)



450.070
Endstück
Kunststoff, schwarz,
für Wetterschenkel 407.009

VE = je 5 Stück
(links und rechts)

450.070
Embout
matière plastique, noire,
pour renvoi d'eau 407.009

UV = 5 paires
(gauche et droite)

450.070
End piece
black, plastic,
for weatherbar 407.009

PU = 5 pieces each
(left and right)



450.030 9 x 4 mm
450.031 9 x 5 mm
450.032 9 x 6 mm
450.034 9 x 8 mm

Distanzband
aus Zellpolyethylen,
geschlossen, weiss,
selbstklebend

Einsatz siehe Seiten 32-37

VE = 50 m

450.030 9 x 4 mm
450.031 9 x 5 mm
450.032 9 x 6 mm
450.034 9 x 8 mm

Bande d'écartement
en polyéthylène cellulaire,
à cellules fermées, blanche,
auto-adhésive

Utilisation voir pages 32-37

UV = 50 m

450.030 9 x 4 mm
450.031 9 x 5 mm
450.032 9 x 6 mm
450.034 9 x 8 mm

Packing tape
closed cell polyethylene,
white, self-adhesive

Application see pages 32-37

PU = 50 m



450.060 9 x 4 mm
450.061 9 x 5 mm
450.062 9 x 6 mm
450.064 9 x 8 mm

Distanzband
aus Zellpolyethylen,
geschlossen, schwarz,
selbstklebend

Einsatz siehe Seiten 32-37

VE = 50 m

450.060 9 x 4 mm
450.061 9 x 5 mm
450.062 9 x 6 mm
450.064 9 x 8 mm

Bande d'écartement
en polyéthylène cellulaire,
à cellules fermées, noire,
auto-adhésive

Utilisation voir pages 32-37

UV = 50 m

450.060 9 x 4 mm
450.061 9 x 5 mm
450.062 9 x 6 mm
450.064 9 x 8 mm

Packing tape
closed cell polyethylene,
black, self-adhesive

Application see pages 32-37

PU = 50 m

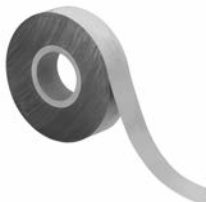

451.051 Breite 40 mm
451.052 Breite 50 mm
451.053 Breite 70 mm
451.054 Breite 95 mm

Schutzfolie
zum Schützen der Sichtflächen
bei Edelstahlprofilen

VE = 1 Rolle à 100 m

451.051 Largeur 40 mm
451.052 Largeur 50 mm
451.053 Largeur 70 mm
451.054 Largeur 95 mm

Film de protection
protège les faces visibles des
profilés en acier Inox

UV = 1 rouleau à 100 m

451.051 Width 40 mm
451.052 Width 50 mm
451.053 Width 70 mm
451.054 Width 95 mm

Protective film
for protecting the sealing surface
of the stainless steel profiles

PU = 1 roll, 100 m each



455.435

Blech-Stoss-Dichtung
EPDM, schwarz,
Blechstärke 2 mm

VE = 50 m

455.435

Joint de dilatation
EPDM, noir,
pour tôle épaisse de 2 mm

UV = 50 m

455.435

Sheet attachment insert gasket
EPDM, black,
plate 2 mm thick

PU = 50 m

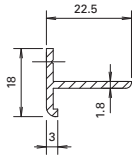

407.304

Aluminium-Zusatzprofil
roh, Gewicht 0,189 kg/m
U = 0,081 m²/m

Länge 6 m

407.304

**Profilé complémentaire
en aluminium**
brut, poids 0,189 kg/m
U = 0,081 m²/m

Longueur 6 m

407.304

Additional profile, aluminium
mill finish, weight 0,189 kg/m
U = 0,081 m²/m

Length 6 m

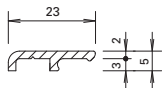

407.099

Aluminium-Zusatzprofil
roh, Gewicht 0,170 kg/m
U = 0,062 m²/m

Länge 6 m

407.099

**Profilé complémentaire
en aluminium**
brut, poids 0,170 kg/m
U = 0,062 m²/m

Longueur 6 m

407.099

Additional profile, aluminium
mill finish, weight 0,170 kg/m
U = 0,062 m²/m

Length 6 m



450.089

Spezialkleber

farblos, schnell härtend, klebt
Kunststoffe und Gummi

VE = 1 Dose à 20 g

450.089

Colle spéciale

incolor, à durcissement rapide,
pour matières plastiques et
caoutchouc

UV = 1 boîte à 20 g

450.089

Special adhesive

colourless, fast-curing, bonds
plastics and rubber

PU = 1 x 20 g can



450.091

Reiniger

zur Reinigung aller Teile vor
dem Anbringen der Kleb- und
Dichtmasse 450.092

VE = 1 Liter

450.091

Nettoyant

Pour nettoyer toutes les pièces
avant d'appliquer la pâte à coller
et à étancher 450.092

UV = 1 litre

450.091

Cleaner

for cleaning all components
before applying the sealing and
bonding compound 450.092

PU = 1 litre



450.092

Kleb- und Dichtmasse

schwarz, für das Abdichten
der Dichtungs-Stösse und
-Durchbrüche

VE = 1 Kartusche 290 ml

Wichtig:

**Ohne Vorbehandlung mit
Reiniger 450.091 ist die Klebe-
haftung nicht gewährleistet.**

450.092

Pâte à coller et à étancher

noire, pour étancher les
raccordements et les points de
raccords des joints intérieurs

UV = 1 cartouche 290 ml

Important:

**Sans traitement préliminaire
avec un nettoyant 450.091,
l'adhésion n'est pas garantie.**

450.092

Sealing and bonding compound

Black, for sealing the joints and
holes in the weatherstrip

PU = 1 cartridge 290 ml

Important:

**Adhesion cannot be guaranteed
unless cleaner 450.091 has been
used as a pre-treatment.**



450.095

Schmalfugen-Dichtmasse

zum Abdichten von schmalen
Fugen, transparent, universell
einsetzbar

VE = 2 Dosen à 375 ml
2 Ersatzdeckel
2 Rundflaschen

Gefahrenstoff:

Warnung auf Packung beachten

450.095

Mastic d'étanchéité pour joints étroits

pour l'étanchéité des joints
étroits, transparent, universel

UV = 2 boîtes à 375 ml
2 couvercles de réserve
2 bouteilles rondes vides

Matière dangereux:

**Observer la mise en garde sur
chaque emballage unitaire**

450.095

Narrow joint sealant

For sealing narrow joints,
transparent, suitable for
universal use



PU = 2 tins at 375 ml
2 replacement lids
2 round bottles

Hazardous substance:

Note warning on packet

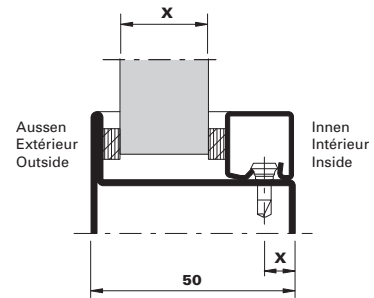
Verglasungstabelle mit Distanzband (Nassverglasung)
Tableau de vitrage avec bande d'écartement (vitrage à mastic)
Glazing table with packing tape (glazing with sealing)

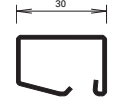
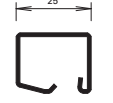
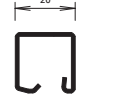
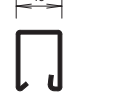

Fugenbreite (mm) Largeur du joint (mm) Width of joint (mm)	Aussen Extérieur Outside	Innen Intérieur Inside	Aussen Extérieur Outside	Innen Intérieur Inside	Aussen Extérieur Outside	Innen Intérieur Inside	Aussen Extérieur Outside	Innen Intérieur Inside	Aussen Extérieur Outside	Innen Intérieur Inside	X	Glasleiste Parclose Glazing bead
	450.032 450.062	450.032 450.062	450.032 450.062	450.031 450.061	450.031 450.061	450.031 450.061	450.031 450.061	450.031 450.061	450.030 450.060	450.030 450.060		
	6	6	6	5	5	5	5	5	4	4		
Verglasung F Vitrage F Glazing F	5		6		7		8		9		9	 402.130 Z 402.430 402.530
	10		11		12		13		14		9	 402.125 Z 402.425 402.525
	15		16		17		18		19		9	 402.120 Z 402.420 402.520
	20		21		22		23		24		9	 402.115 Z 402.415 402.515
					25		26		27		7	 402.112 Z

Hinweise Verglasungsvarianten
siehe Seite 38

Remarques variantes de vitrage
voir page 38

Notices alternative glazings
see page 38

Verglasungstabelle mit Distanzband (Nassverglasung)
 Tableau de vitrage avec bande d'écartement (vitrage à mastic)
 Glazing table with packing tape (glazing with sealing)

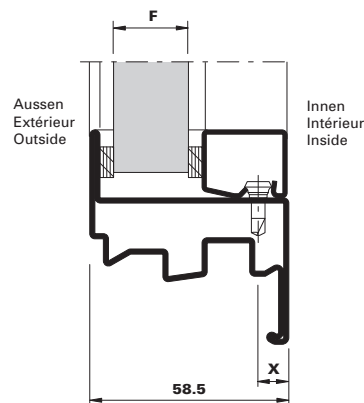

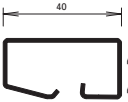
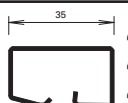
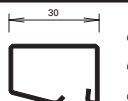
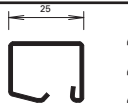
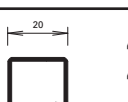
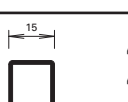
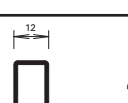
Fugenbreite (mm) Largeur du joint (mm) Width of joint (mm)	Aussen Extérieur Outside	Innen Intérieur Inside	Aussen Extérieur Outside	Innen Intérieur Inside	Aussen Extérieur Outside	Innen Intérieur Inside	Aussen Extérieur Outside	Innen Intérieur Inside	Aussen Extérieur Outside	Innen Intérieur Inside	X	Glasleiste Parclose Glazing bead
	450.032 450.062	450.032 450.062	450.032 450.062	450.031 450.061	450.031 450.061	450.031 450.061	450.031 450.061	450.031 450.061	450.030 450.060	450.030 450.060		
	6	6	6	5	5	5	5	4	4	4		
Verglasung F Vitrage F Glazing F					5		6		7		18	 402.140 Z 402.540
	8	9	10	11	12	18	 402.135 Z 402.435 402.535					
	13	14	15	16	17	9	 402.130 Z 402.430 402.530					
	18	19	20	21	22	9	 402.125 Z 402.425 402.525					
	23	24	25	26	27	9	 402.120 Z 402.420 402.520					
	28	29	30	31	32	9	 402.115 Z 402.415 402.515					
			33	34	35	7	 402.112 Z					

Hinweise Verglasungsvarianten
 siehe Seite 38

Remarques variantes de vitrage
 voir page 38

Notices alternative glazings
 see page 38

Verglasungstabelle mit Distanzband (Nassverglasung)
 Tableau de vitrage avec bande d'écartement (vitrage à mastic)
 Glazing table with packing tape (glazing with sealing)

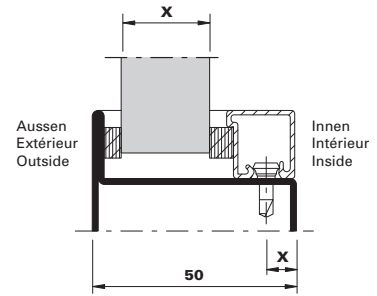

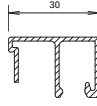
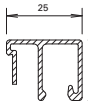
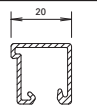
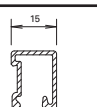
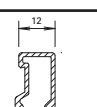
Fugenbreite (mm) Largeur du joint (mm) Width of joint (mm)	Aussen Extérieur Outside	Innen Intérieur Inside	Aussen Extérieur Outside	Innen Intérieur Inside	Aussen Extérieur Outside	Innen Intérieur Inside	Aussen Extérieur Outside	Innen Intérieur Inside	Aussen Extérieur Outside	Innen Intérieur Inside	X	Glasleiste Parclose Glazing bead
		450.032 450.062	450.034 450.064	450.031 450.061	450.034 450.064	450.032 450.062	450.032 450.062	450.031 450.061	450.032 450.062	450.030 450.060		
	6	6	5	6	6	4	5	4	4	4		
Verglasung F Vitrage F Glazing F	5		6		7		8		9		9	 404.130
	10		11		12		13		14		9	 404.125
	15		16		17		18		19		9	 404.120
	20		21		22		23		24		9	 404.115
					25		26		27		7	 404.112

Hinweise Verglasungsvarianten
 siehe Seite 38

Remarques variantes de vitrage
 voir page 38

Notices alternative glazings
 see page 38

Verglasungstabelle mit Distanzband (Nassverglasung)
 Tableau de vitrage avec bande d'écartement (vitrage à mastic)
 Glazing table with packing tape (glazing with sealing)

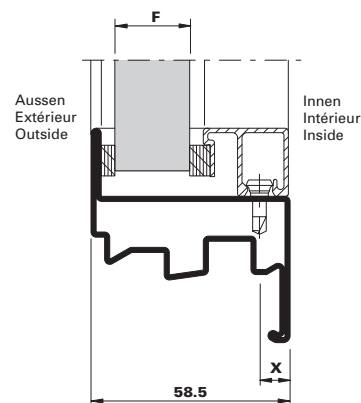

Fugenbreite (mm) Largeur du joint (mm) Width of joint (mm)	Aussen Extérieur Outside	Innen Intérieur Inside	Aussen Extérieur Outside	Innen Intérieur Inside	Aussen Extérieur Outside	Innen Intérieur Inside	Aussen Extérieur Outside	Innen Intérieur Inside	Aussen Extérieur Outside	Innen Intérieur Inside	X	Glasleiste Parclose Glazing bead
	450.032 450.062	450.034 450.064	450.031 450.061	450.034 450.064	450.032 450.062	450.032 450.062	450.031 450.061	450.032 450.062	450.030 450.060	450.032 450.062		
	6	6	5	6	6	4	5	4	4	4		
Verglasung F Vitrage F Glazing F					5		6		7		9	404.140
	8		9		10		11		12		9	404.135
	13		14		15		16		17		9	404.130
	18		19		20		21		22		9	404.125
	23		24		25		26		27		9	404.120
	28		29		30		31		32		9	404.115
					33		34		35		9	404.112

Hinweise Verglasungsvarianten
 siehe Seite 38

Remarques variantes de vitrage
 voir page 38





Notices alternative glazings
 see page 38

Verglasungstabelle mit Distanzband
 (Nassverglasung)

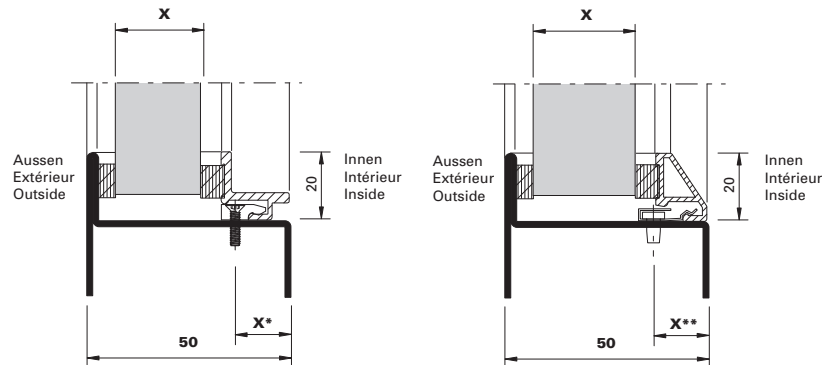
Tableau de vitrage avec bande d'écartement
 (vitrage à mastic)

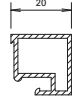
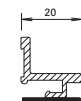
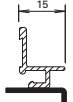
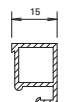
Glazing table with packing tape
 (glazing with sealing)

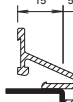

Fugenbreite (mm) Largeur du joint (mm) Width of joint (mm)	Aussen Extérieur Outside	Innen Intérieur Inside	Aussen Extérieur Outside	Innen Intérieur Inside	Aussen Extérieur Outside	Innen Intérieur Inside	Aussen Extérieur Outside	Innen Intérieur Inside	Aussen Extérieur Outside	Innen Intérieur Inside	X	Glasleiste Parclose Glazing bead
	450.031 450.061	450.034 450.064	450.032 450.062	450.032 450.062	450.031 450.061	450.031 450.061	450.031 450.061	450.031 450.061	450.030 450.060	450.031 450.061		
	5	7	6	5	5	5	5	4	4	4		
Verglasung F Vitrage F Glazing F	15		16		17		18		19		16* 21**	 405.120  406.909
											16* 21**	 406.903
	20		21		22		23		24			 405.115
											11* 16**	 406.905  406.907
												 406.996  406.901

* Bohrabstand für Knopf 450.020
 ** Bohrabstand für Feder 450.022

* Distance de perçage pour bouton 450.020
 ** Distance de perçage pour ressort 450.022

* Drilling distance for stud 450.020
 ** Drilling distance for spring 450.022

Diese Glasleisten sind nur in Verbindung mit Nassverglasung (Silikon-Versiegelung) geeignet.

Ces parclose ne conviennent que dans le cas d'un vitrage à mastic.



These glazing beads are suitable only for use with glazing with sealing.

Verglasungstabelle mit Distanzband
 (Nassverglasung)

Tableau de vitrage avec bande d'écartement
 (vitrage à mastic)

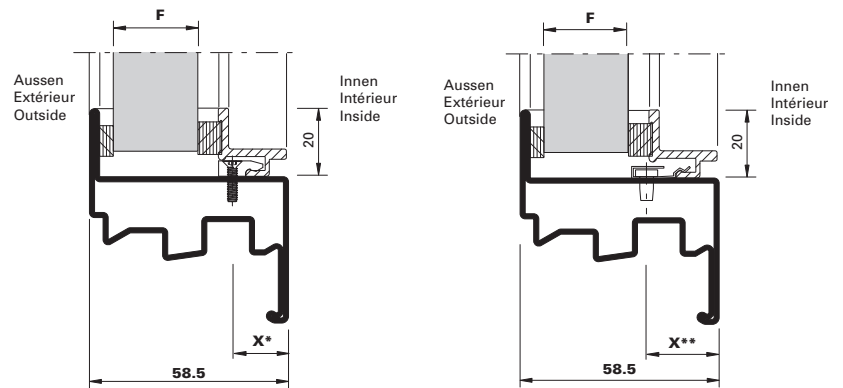
Glazing table with packing tape
 (glazing with sealing)

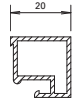
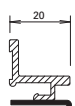
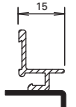
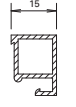

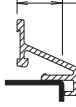
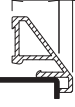
Fugenbreite (mm) Largeur du joint (mm) Width of joint (mm)	Aussen Extérieur Outside	Innen Intérieur Inside	Aussen Extérieur Outside	Innen Intérieur Inside	Aussen Extérieur Outside	Innen Intérieur Inside	Aussen Extérieur Outside	Innen Intérieur Inside	Aussen Extérieur Outside	Innen Intérieur Inside	X	Glasleiste Parclose Glazing bead	
	450.031 450.061	450.034 450.064	450.032 450.062	450.032 450.062	450.031 450.061	450.032 450.062	450.031 450.061	450.031 450.061	450.030 450.060	450.031 450.061			
Verglasung F Vitrage F Glazing F	23		24		25		26		27		16* 21**	 405.120	 406.909
	28		29		30		31		32			16* 21**	 406.903
	28		29		30		31		32		11* 16**	 405.115	
	28		29		30		31		32			 406.905	 406.907
	28		29		30		31		32			 406.996	 406.901
	28		29		30		31		32				

* Bohrabstand für Knopf 450.020
 ** Bohrabstand für Feder 450.022

* Distance de perçage pour bouton 450.020
 ** Distance de perçage pour ressort 450.022

* Drilling distance for stud 450.020
 ** Drilling distance for spring 450.022

Diese Glasleisten sind nur in Verbindung mit Nassverglasung (Silikon-Versiegelung) geeignet.

Ces parcloles ne conviennent que dans le cas d'un vitrage à mastic.

These glazing beads are suitable only for use with glazing with sealing.

**Wichtiger Hinweis:
Nassverglasung**

Grundlage der Verglasungstabelle sind die Nennmasse der Profile und Füllelemente. Bedingt durch verschiedene Toleranzen (Profile, Glasleisten, Anordnung Befestigungsknöpfe und Glaselemente) empfehlen wir, die Wahl der inneren Distanzbänder vorgängig an einem Element zu prüfen. Gegebenenfalls kommt die nächst kleinere oder grössere Glasleiste/Distanzband zur Anwendung.

Die Masse entsprechen ungefähr einer rahmenbündigen Glasleisten-Montage.

Wir empfehlen, die Glasleisten nur auf der Raumseite anzuwenden.

Betreffend Fugendimensionierung und Fugenausbildung verweisen wir auf die Richtlinien der Glashersteller.

**Remarque importante:
Vitrage à mastic**

Les cotes nominales des profilés et des éléments de remplissage sont la base du tableau de vitrage. A cause des différentes tolérances (profilés, parcloles, disposition boutons de fixation et éléments vitrés) nous recommandons d'effectuer un essai préalable avec la bande d'écartement choisie sur un élément. Le cas échéant, utiliser la parclose / la bande d'écartement de la taille inférieure ou supérieure.

Les distances correspondent à peu près au montage des parcloles à fleur du cadre.

Nous recommandons de n'utiliser les parcloles que du côté intérieur.

En ce qui concerne le dimensionnement et la formation des joints nous renvoyons aux directives du fabricant de verre.







**Important notice:
Glazing with sealing**

The glazing table is based on the nominal dimensions of the profiles and infill panels. Owing to variations in the tolerances (profiled sections, glazing beads, layout of fastening studs and glazing) it is advisable to check your choice of inside packing tapes on an infill panel beforehand. If necessary the next smaller or larger size glazing bead/packing tape can be used.

Distances correspond approximately to glazing beads mounted flush to the frame.

We recommend fitting the glazing beads on the room-side only.

Referring to joint dimensioning and joint form we refer you to the guidelines of glass manufacturer.

	Inhaltsverzeichnis	Sommaire	Content	
	Beschläge	Ferrures	Fittings	40
Standard-Fensterbeschlag				
	Standard-Fensterbeschlag	Ferrure de fenêtre Standard	Standard window fitting	
	Technische Daten	Données techniques	Technical data	48
	Drehkipp- und Drehbeschlag	Ferrure oscillo-battante et à la française	Turn/tilt and side-hung fitting	50
	Stulp-Beschlag	Ferrure pour fenêtre à deux vantaux	Double leaf window fitting	58
	Kipp-Beschlag	Ferrure à soufflet	Bottom-hung fitting	67
Verdeckt liegender Fensterbeschlag				
	Verdeckt liegender Fensterbeschlag	Ferrure de fenêtre non apparente	Concealed window fitting	
	Technische Daten	Données techniques	Technical data	76
	Verdeckt liegender Drehkipp- und Drehbeschlag	Ferrure oscillo-battante et à la française non apparente	Concealed turn/tilt and side-hung fitting	78
	Verdeckt liegender Stulp-Beschlag	Ferrure pour fenêtre à deux vantaux non apparente	Concealed double leaf window fitting	86
Sondergeometrien				
	Sondergeometrien	Géométrie spéciale	Special geometry	94
Oberlichtöffner				
	Oberlichtöffner	Ferrure d'imposte	Top light opener	102
Verarbeitungshilfen				
	Verarbeitungshilfen	Outils d'usinage	Assembly tools	111



557.200

Fenstergriff Aluminium (silber)

mit Vierkantdorn 7 mm, inkl.
2 Befestigungsschrauben M5x30

Höhe: ca. 130 mm

Tiefe: ca. 50 mm

VE = 1 Stück

557.200

Poignée en aluminium (argenté)

avec tige carrée 7 mm, 2 vis
de fixation M5x30 incluses

Hauteur: env. 130 mm

Profondeur: env. 50 mm

UV = 1 pièce

557.200

Handle, aluminium (silver)

with square spindle 7 mm,
incl. 2 fixing screws M5x30

Height: approx. 130 mm

Depth: approx. 50 mm

PU = 1 piece



557.201

Fenstergriff Aluminium (silber)

abschliessbar

mit Vierkantdorn 7 mm, inkl.
2 Befestigungsschrauben M5x30

Höhe: ca. 140 mm

Tiefe: ca. 50 mm

VE = 1 Stück

557.201

Poignée en aluminium (argenté)

fermant à clé

avec tige carrée 7 mm, 2 vis
de fixation M5x30 incluses

Hauteur: env. 140 mm

Profondeur: env. 50 mm

UV = 1 pièce

557.201

Handle, aluminium (silver)

lockable

with square spindle 7 mm, incl.
2 fixing screws M5x30

Height: approx. 140 mm

Depth: approx. 50 mm

PU = 1 piece



557.202

Steckgriff Aluminium (silber)

mit Vierkantdorn 7 mm

Höhe: ca. 130 mm

Tiefe: ca. 50 mm

VE = 1 Stück

Einsatz:
mit Abdeckrosette 557.203

557.202

Poignée amovible en aluminium (argenté)

avec tige carrée 7 mm

Hauteur: env. 130 mm

Profondeur: env. 50 mm

UV = 1 pièce

Utilisation:
avec capot-rosace 557.203

557.202

Slot-in handle, aluminium (silver)

with square spindle 7 mm

Height: approx. 130 mm

Depth: approx. 50 mm

PU = 1 piece

Application:
with covering rose 557.203



557.204

Edelstahl-Griff

matt gebürstet, mit Vierkantdorn
7 mm, inkl. 2 Befestigungs-
schrauben M5x30

Höhe: ca. 125 mm

Tiefe: ca. 58 mm

VE = 1 Stück

557.204

Poignée en acier Inox

brossée mat, avec tige
carrée 7 mm, 2 vis de fixation
M5x30 incluses

Hauteur: env. 125 mm

Profondeur: env. 58 mm

UV = 1 pièce

557.204

Handle, stainless steel

matt brushed, with square
spindle 7 mm, incl. 2 fixing
screws M5x30

Height: approx. 125 mm

Depth: approx. 58 mm

PU = 1 piece



557.203

Abdeckrosette Aluminium (silber)
inkl. 2 Befestigungsschrauben M5x30

VE = 1 Stück

Einsatz:
mit Steckgriff 557.202

557.203

Capot-rose en aluminium (argenté)
2 vis de fixation M5x30 incluses

UV = 1 pièce

Utilisation:
avec pognée amovible 557.202

557.203

Covering rose, aluminium (silver)
incl. 2 fixing screws M5x30

PU = 1 piece

Application:
with slot-in handle 557.202



557.210 silber
557.211 weiss

Abdeckkappen oben
für Abdeckung der Scherenlager, Scherenbänder, Drehbänder und Kippbänder

VE = 20 Scherenbandkappen
20 Scherenlagerkappen

Einsatz:
Standard-Fensterbeschlag

557.210 argenté
557.211 blanc

Capuchon haut
pour couvrir les charnières supérieures du ciseaux, charnières-compas, charnières à la françaises et charnières à soufflet

UV = 20 capuchons pour charnières
20 capuchons pour pivots

Utilisation:
Ferrure de fenêtre Standard

557.210 silver
557.211 white

Cover caps top
for covering the scissor stay, scissor hinge, side-hung hinges and bottom-hung hinges

PU = 20 cover caps for scissor hinges
20 cover caps for scissor stays

Application:
Standard window fitting



557.212 silber DIN links
557.213 weiss DIN links
557.214 silber DIN rechts
557.215 weiss DIN rechts

Abdeckkappen unten
für Abdeckung der Flügellager und Ecklager

VE = 20 Flügellagerkappen
20 Ecklagerkappen

Einsatz:
Standard-Fensterbeschlag

557.212 argenté DIN gauche
557.213 blanc DIN gauche
557.214 argenté DIN droite
557.215 blanc DIN droite

Capuchon bas
pour couvrir les fiches d'angle du vantail et charnières inférieures d'angle

UV = 20 capuchons pour fiches d'angle du vantail
20 capuchons pour charnières inférieures d'angle

Utilisation:
Ferrure de fenêtre Standard

557.212 silver DIN left
557.213 white DIN left
557.214 silver DIN right
557.215 white DIN right

Cover caps bottom
for covering leaf hinges and corner hinges

PU = 20 cover caps for leaf hinges
20 cover caps for corner hinges

Application:
Standard window fitting



599.400

Anschlagplatte

Stahl, Silberlook-Oberfläche,
Einsatz als Kippsperre für
Drehflügel

VE = 1 Stück

Einsatz:
Standard- und verdeckt
liegender Fensterbeschlag

599.400

Plaque butée

acier, surface argentée, utilisée
comme blocage de position
soufflet pour fenêtre à la
française

UV = 1 pièce

Utilisation:
Ferrure de fenêtre Standard
et non-apparente

599.400

Stop plate

steel, silver-look surface finish,
use as tilt lock for side-hung
window

PU = 1 piece

Application:
Standard and concealed
window fitting



599.481

Zuschlagsicherung

Kunststoff, Einsatz
bei Drehkipfenster in
Oberschiene

VE = 1 Stück

Einsatz:
Standard-Fensterbeschlag

599.481

Sécurité fermeture brusque

matière plastique, pour
les fenêtres oscillo-battantes,
montable dans la tringle
supérieure

UV = 1 pièce

Utilisation:
Ferrure de fenêtre Standard

599.481

Extra security device

plastic, used in top rail of
turn/tilt window

PU = 1 piece

Application:
Standard window fitting



599.431 DIN links

599.432 DIN rechts

**Mehrfachspaltlüftung
Standard**

Stahl, Silberlook-Oberfläche,
für den Einsatz in Oberschiene,
ab FFB 600 mm, erlaubt
zusätzliche Lüftungsstufen,
über Fenstergriff einstellbar.

VE = 1 Stück

Einsatz:
Standard-Fensterbeschlag

599.431 DIN gauche

599.432 DIN droite

**Limiteur d'aérations multiples
Standard**

acier, surface argentée, pour
utilisation dans la tringle
supérieure, dès FFB 600 mm,
permet de ventilation
supplémentaires, réglable par
l'intermédiaire de la poignée.

UV = 1 pièce

Utilisation:
Ferrure de fenêtre Standard

599.431 DIN LH

599.432 DIN RH

**Multi-point ventilation
Standard**

steel, silverlook surface,
plated for use in top rail,
from FFB 600 mm, allows
ventilation levels, adjustable
over window handle.

PU = 1 piece

Application:
Standard window fitting



599.401

Balkontürschnäpper

Stahl, Silberlook-Oberfläche,
Einsatz bei Balkontüre

Einsatz:

- Balkontüre 1-flügelig
vertikal (Getriebeseite)
- Balkontüre 2-flügelig
horizontal unten

VE = 1 Stück

Schraubenbedarf:
2 x M4x12 (aus 557.046)

Einsatz:
Standard- und verdeckt
liegender Fensterbeschlag

599.401

Loqueteau pour porte de balcon

acier, surface argentée,
pour porte de balcon

Utilisation:

- Porte de balcon 1 vantail
vertical (côté crémone)
- Porte de balcon 2 vantaux
horizontal inférieur

UV = 1 pièce

Vis nécessaires:
2 x M4x12 (de 557.046)

Utilisation:
Ferrure de fenêtre Standard
et non-apparente

599.401

Balcony door catch

steel, silverlook surface,
for balcony doors

Application:

- balcony door single-leaf
vertical (mechanism side)
- balcony door double-leaf
horizontal bottom

PU = 1 piece

Screws usage:
2 x M4x12 (of 557.046)

Application:
Standard and concealed
window fitting



599.419

Schnäpperbolzen

Stahl, Silberlook-Oberfläche,
Einsatz bei ein- oder zwei-
flügeliger Balkontüre,
Standflügel (horizontal unten)

VE = 1 Stück

Schraubenbedarf:
2 x M4x20 (aus 557.045)

Einsatz:
Standard- und verdeckt
liegender Fensterbeschlag

599.419

Goujon d'encliquetage

acier, surface argentée,
pour porte de balcon à un
ou deux vantaux, vantail
semi-fixe (horizontal inférieur)

UV = 1 pièce

Vis nécessaires:
2 x M4x20 (de 557.045)

Utilisation:
Ferrure de fenêtre Standard
et non-apparente

599.419

Bolt for spring-loaded catch

steel, silverlook surface,
for single- or double-leaf
balcony doors, secondary leaf
(horizontal bottom)

PU = 1 piece

Screws usage:
2 x M4x20 (of 557.045)

Application:
Standard and concealed
window fitting

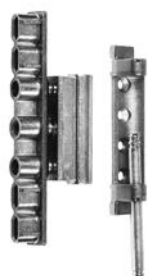

557.216

Kippflügelband Standard

Silberlook-Oberfläche,
für Kippflügel

Passende Abdeckkappen:
557.210 silber
557.211 weiss

VE = 1 Kippband
1 Scherenlager
1 Unterlage

Schraubenbedarf:
4 x M4x12 (aus 557.046)
4 x M4x20 (aus 557.045)

Einsatz:
Standard-Fensterbeschlag

557.216

Charnière d'imposte Standard

surface argentée,
pour vantail à soufflet

Capuchons correspondants:
557.210 argenté
557.211 blanc

UV = 1 charnière à soufflet
1 charnière supérieur
du ciseaux
1 cale

Vis nécessaires:
4 x M4x12 (de 557.046)
4 x M4x20 (de 557.045)

Utilisation:
Ferrure de fenêtre Standard

557.216

Bottom-hung hinge Standard

silverlook surface,
for bottom-hung window

Matching cover caps:
557.210 silver
557.211 white

PU = 1 bottom-hung hinge
1 scissor hinge part
1 support

Screws usage:
4 x M4x12 (of 557.046)
4 x M4x20 (of 557.045)

Application:
Standard window fitting



599.480

Öffnungsbegrenzer mit Drehbremse

Stahl, Silberlook-Oberfläche, einsetzbar ab FFB 480 mm, Bremskraft einstellbar, Öffnungswinkel 70° – 90°

VE = 1 Stück

Schraubenbedarf:

1 x M4x20 (aus 557.045)

5 x M4x12 (aus 557.046)

Einsatz:

Standard-Fensterbeschlag

599.480

Compas de limitation d'ouverture avec frein

acier, surface argentée, utilisable dès FFB 480 mm, Force de freinage réglable, angle d'ouverture 70° à 90°

UV = 1 pièce

Vis nécessaires:

1 x M4x20 (de 557.045)

5 x M4x12 (de 557.046)

Utilisation:

Ferrure de fenêtre Standard

599.480

Opening limiter with swivel brake

steel, silverlook surface, suitable from FFB 480 mm, Braking force can be adjusted, opening angle 70 – 90 degrees

PU = 1 piece

Screws usage:

1 x M4x20 (of 557.045)

5 x M4x12 (of 557.046)

Application:

Standard window fitting



557.220

Sicherungsschere 300

Stahl, schwarz und Silberlook-Oberfläche, für Kippflügel mit Hub 327 mm

VE = 2 Sicherungsscheren
2 Flügelunterlagen

Schraubenbedarf:

3 x M4x12 (aus 557.046)

2 x M4x20 (aus 557.045)

Einsatz:

Bei Kippflügeln, die nur mit einem Verriegelungspunkt gehalten werden.

557.220

Compas de sécurité 300

Acier, surface noire et argentée, pour vantaux à soufflets avec course de 327 mm

UV = 2 compas de sécurité
2 cales de vantail

Vis nécessaires:

3 x M4x12 (de 557.046)

2 x M4x20 (de 557.045)

Utilisation:

Pour les vantaux à soufflets qui ne sont maintenus que par un point de verrouillage.

557.220

Security stay 300

Steel, black and silver-look surface finish, for bottom-hung vents with a length of travel of 327 mm

PU = 2 security stays
2 vent supports

Screws usage:

3 x M4x12 (of 557.046)

2 x M4x20 (of 557.045)

Application:

For bottom-hung vents, which are only held in place by one locking point.

557.221

Sicherungsschere 600

wie 557.220, jedoch für Hub 600 mm

Einsatz:

Bei Kippflügeln, die nur mit einem Verriegelungspunkt gehalten werden.

557.221

Compas de sécurité 600

comme 557.220, mais pour une course de 600 mm

Utilisation:

Pour les vantaux à soufflets qui ne sont maintenus que par un point de verrouillage.

557.221

Security stay 600

As 557.220, except for a length of travel of 600 mm

Application:

For bottom-hung vents, which are only held in place by one locking point.



557.219

Kippschere

Stahl, Silberlook-Oberfläche,
für Kippflügel

VE = 1 Falzschere
1 Unterfütterung

Schraubenbedarf:

3 x M4x12 (aus 557.046)
2 x M4x20 (aus 557.045)

Einsatz:
Standard- und verdeckt
liegender Fensterbeschlag

557.219

Compas d'imposte

acier, surface argentée,
pour vantail à soufflet

UV = 1 compas d'arrêt
1 cale

Vis nécessaires:

3 x M4x12 (de 557.046)
2 x M4x20 (de 557.045)

Utilisation:
Ferrure de fenêtre Standard et
non-apparente

557.219

Tilt scissor

steel, silverlook surface,
for bottom-hung vents

PU = 1 rebate stay
1 support

Screws usage:

3 x M4x12 (of 557.046)
2 x M4x20 (of 557.045)

Application:
Standard and concealed
window fitting



557.010

Aluminium-Schnäpper

eloxiert EV1, komplett,
inkl. Befestigungsmaterial

VE = 1 Schnäpper
1 Fangteil

557.010

Loqueteau d'imposte

éloxé naturel EV1, complet,
matériel de fixation inclus

UV = 1 loqueteau
1 pièce de réception

557.010

Aluminium catch

anodised EV1, complete,
incl. fixing material

PU = 1 catch
1 locking plate



550.319

Ziehgriff

Aluminium, EV1 eloxiert,
inkl. Befestigungsmaterial

VE = 1 Ziehgriff

550.319

Poignée de tirage

aluminium, anodisé EV1,
matériel de fixation inclus

UV = 1 poignée de tirage

550.319

Pull handle

anodised aluminium EV1,
incl. fixing material

PU = 1 pull handle

Historisches Museum, Casa padellás, Barcelona/ES (Architekt: Josep Llinás, Barcelona/ES)



Standard-Fensterbeschlag

- Einhandbeschlag für Dreh-, Drehkipp-, Stulp- und Kippfenster
- Fensterbeschlag mit Pilzkopfverriegelung für erhöhte Einbruch-Sicherheit
- Anpressdruck verstellbar
- Flügel seitlich und in der Höhe regulierbar
- Keine Ausnehmungen für Bauteile erforderlich
- Rationeller Einbau dank praktischer Verarbeitungs-Hilfsmitteln
- optional Mehrfachspaltlüftung
- optional Zuschlagsicherung
- Korrosionsbeständigkeit nach EN ISO 9227-NS Klasse 4 nach EN 1670

Ferrure de fenêtre Standard

- Ferrure une main pour fenêtres à la française, oscillo-battantes, pour fenêtres à deux vantaux et à soufflet
- Ferrure de fenêtre avec verrouillage champignon pour une meilleure sécurité anti-effraction
- Pression d'appui réglable
- Vantaux réglables sur le côté et en hauteur
- Aucun évidement nécessaire pour les éléments de paumelle
- Montage rationnel grâce aux outils d'usinage pratiques
- en option limiteur d'aération multiple
- en option sécurité fermeture brusque
- Résistance à la corrosion selon EN ISO 9227-NS classe 4 selon EN 1670

Standard window fitting

- Single-handed fitting for tilt, turn/tilt, double leaf and bottom-hung window
- Window fitting with mushroom closure for enhanced anti-burglar security
- Contact pressure adjustable
- Leaf can be regulated on the side and vertically
- No recesses necessary for hinge parts
- Efficient installation thanks to practical assembly tools
- Optional multi-point ventilation
- Optional anti-slam fitting
- Corrosion resistance in accordance with EN ISO 9227-NS Class 4 in accordance with EN 1670



Folgende technische Rahmenbedingungen müssen beachtet werden:

Allgemein:

Max. Gewicht:	bis 150 kg
Max. Fläche:	3.0 m ²
Max. Seitenverhältnis FFB/FFH:	≤ 2:1
G-Mass min.:	288 mm

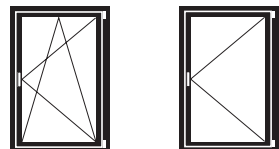

Flügelgrößen Drehkipp- und Drehfenster:

Max.	FFH = 2300 mm FFB = 1475 mm
Min.	FFH = 575 mm FFB = 370 mm

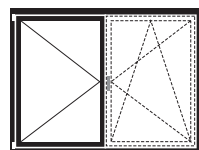

Flügelgröße Stulp-Fenster:

Max.	FFH = 2300 mm FFB = 1475 mm
Min.	Stulpflügel-Getriebe: FFH = 575 mm FFB = 370 mm

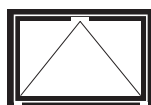

Flügelgröße Kipp-Fenster:

Max.	FFH = 2300 mm FFB = 2300 mm
Min.	FFH = 370 mm FFB = 575 mm
Max. Gewicht:	120 kg (3 Bänder) 80 kg (2 Bänder)

Bei FFB/FFH ≤ 500 mm Flügelrahmen um 1 mm im Minus zuschneiden!

Sondergeometrien siehe Seite 94

Les conditions cadres techniques suivantes doivent être observées:

Généralités:

Poids max.:	jusqu'à 150 kg
Surface max.:	3.0 m ²
Rapport latéral max. largeur/hauteur FFB/FFH:	≤ 2:1
Mesure G min.:	288 mm

Grandeurs du vantail fenêtre oscillo-battante et à la française:

Max.	FFH = 2300 mm FFB = 1475 mm
Min.	FFH = 575 mm FFB = 370 mm

Grandeur du vantail fenêtre à deux vantaux:

Max.	FFH = 2300 mm FFB = 1475 mm
Min.	Mécanisme de vantail semi-fixe: FFH = 575 mm FFB = 370 mm

Grandeur du vantail fenêtre à soufflet:

Max.	FFH = 2300 mm FFB = 2300 mm
Min.	FFH = 370 mm FFB = 575 mm
Poids max.:	120 kg (3 paumelles) 80 kg (2 paumelles)

Si FFB/FFH ≤ 500 mm, le cadre de vantail doit être coupé d'un millimètre de moins que la longueur théorique!

Géométrie spéciale voir page 94

The following technical limiting conditions must be duly considered:

General:

Max. weight:	to 150 kg
Max. surface:	3.0 m ²
Max. ratio width/height FFB/FFH:	≤ 2:1
G-measurement min.:	288 mm

Size of leafs turn/tilt and side-hung windows:

Max.	FFH = 2300 mm FFB = 1475 mm
Min.	FFH = 575 mm FFB = 370 mm

Size of leaf double-leaf window:

Max.	FFH = 2300 mm FFB = 1475 mm
Min.	Double-leaf operating mechanism: FFH = 575 mm FFB = 370 mm

Size of leaf bottom-hung window:

Max.	FFH = 2300 mm FFB = 2300 mm
Min.	FFH = 370 mm FFB = 575 mm
Max. weight:	120 kg (3 hinges) 80 kg (2 hinges)

If FFB/FFH ≤ 500 mm, cut the leaf frame to 1 mm less than the nominal length!

Special geometry see page 94

Max. Gewicht für Dreh- und Drehkipp-Fenster in Abhängigkeit Verhältnis Flügelfalzbreite (FFB) / Flügelfalzhöhe (FFH)

Poids maximal pour les fenêtres à la française et oscillo-battantes en fonction du rapport largeur de feuillure du vantail (FFB) / hauteur de feuillure du vantail (FFH)

Max. weight for side-hung and turn/tilt windows dependent on the relationship between leaf rebate width (FFB) / leaf rebate height (FFH)

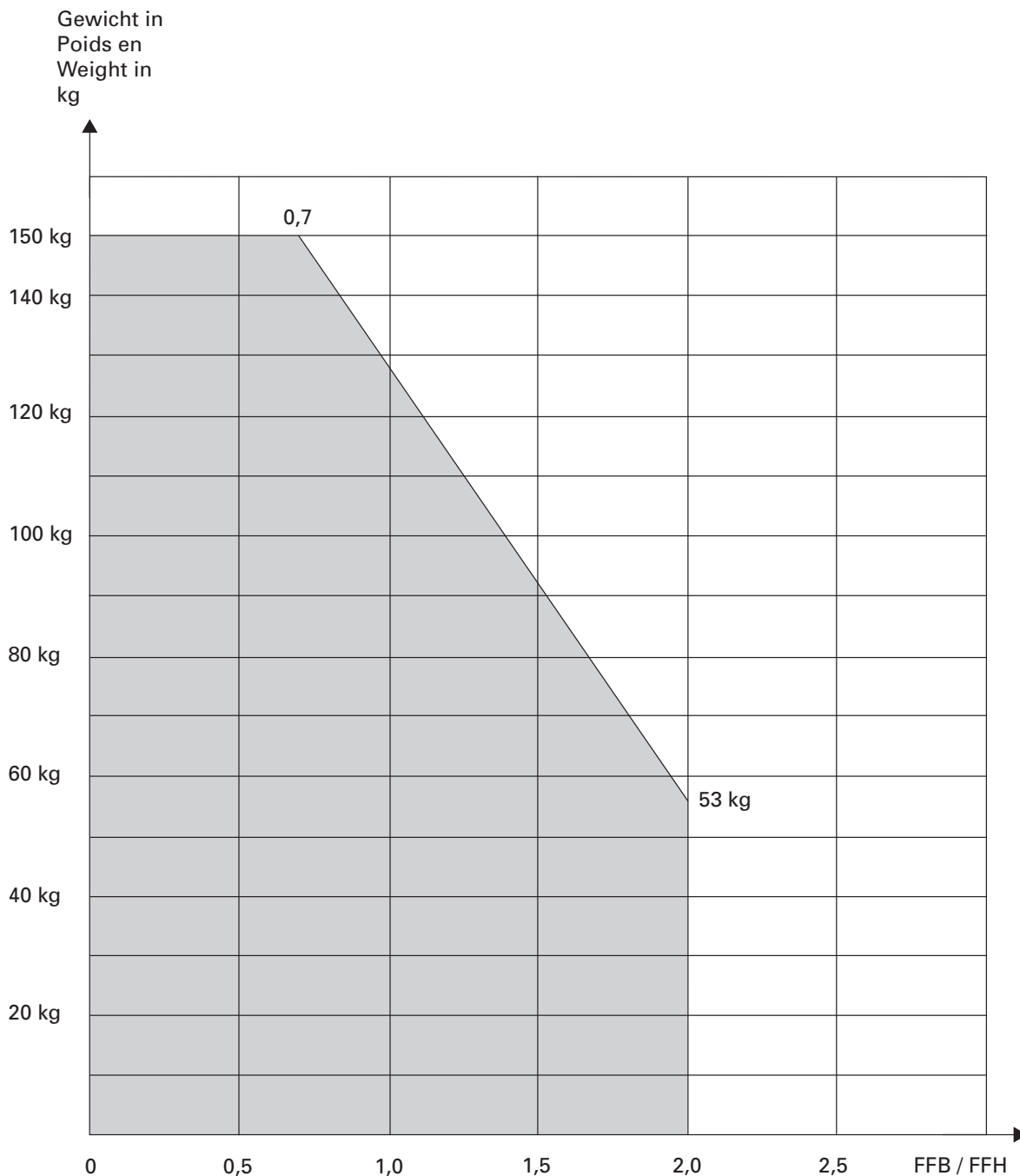

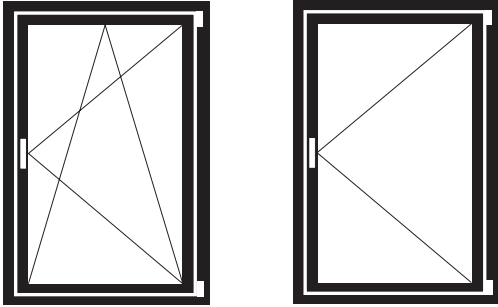

Drehkipp- und Drehbeschlag

Ferrure oscillo-battante et à la française

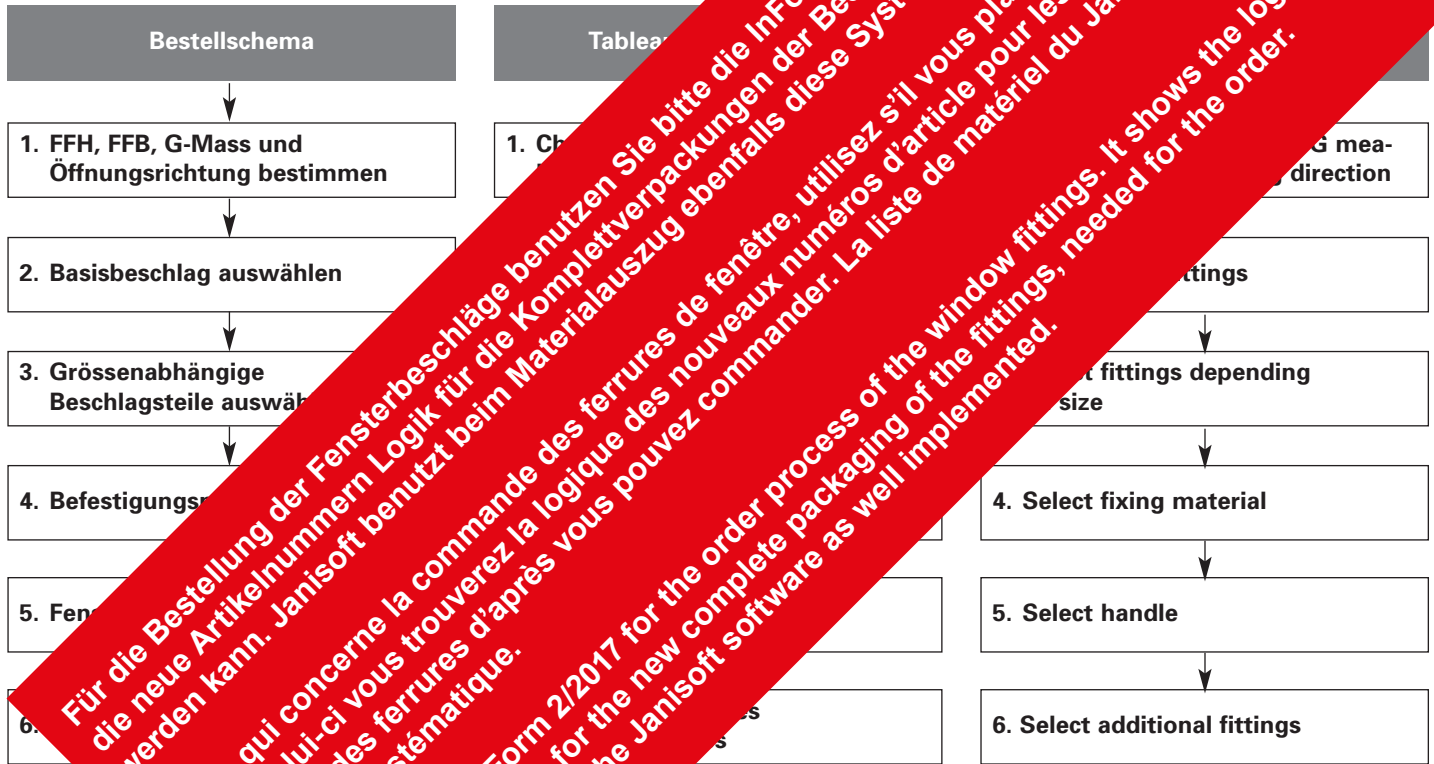

Zusätzlich bestellen:
 - Beim Drehflügel zu Drehkippbeschlag Art. 599.400 bestellen

Commander séparément:
 - Commander une plaque-butée 599.400 en plus de la ferrure oscillo-battante pour l'ouvrant à la française

Order separately:
 - For side-hung vents, order stop plate 599.400 in addition to the turn/tilt fitting

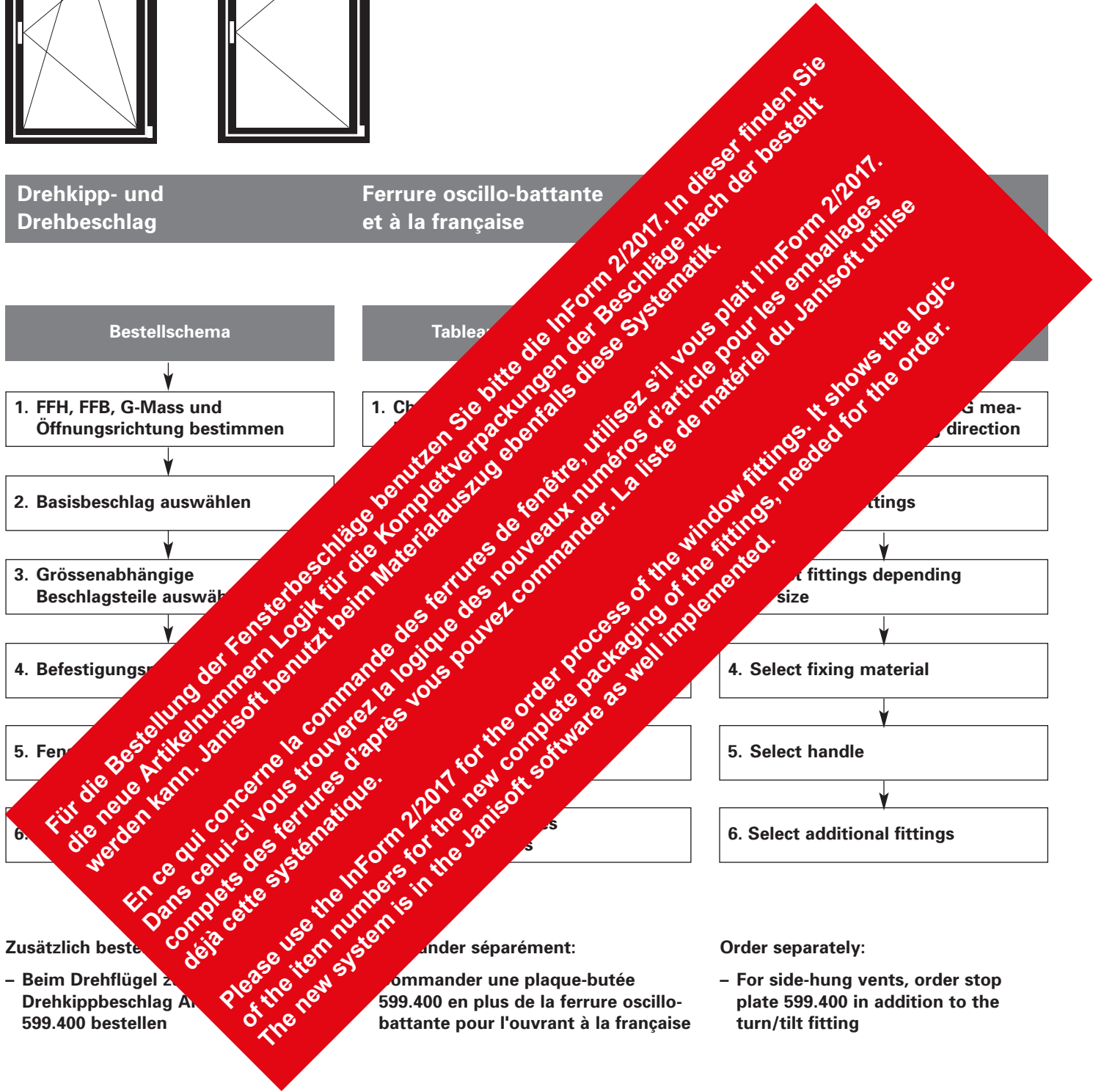

1. FFH, FFB, G-Mass und
 Öffnungsrichtung
 bestimmen

1. Choisir FFH, FFB,
 la mesure G et
 l'orientation de l'ouverture

1. Determine the vent rebate
 height (FFH), vent rebate
 width (FFB),
 G measurement and
 opening direction

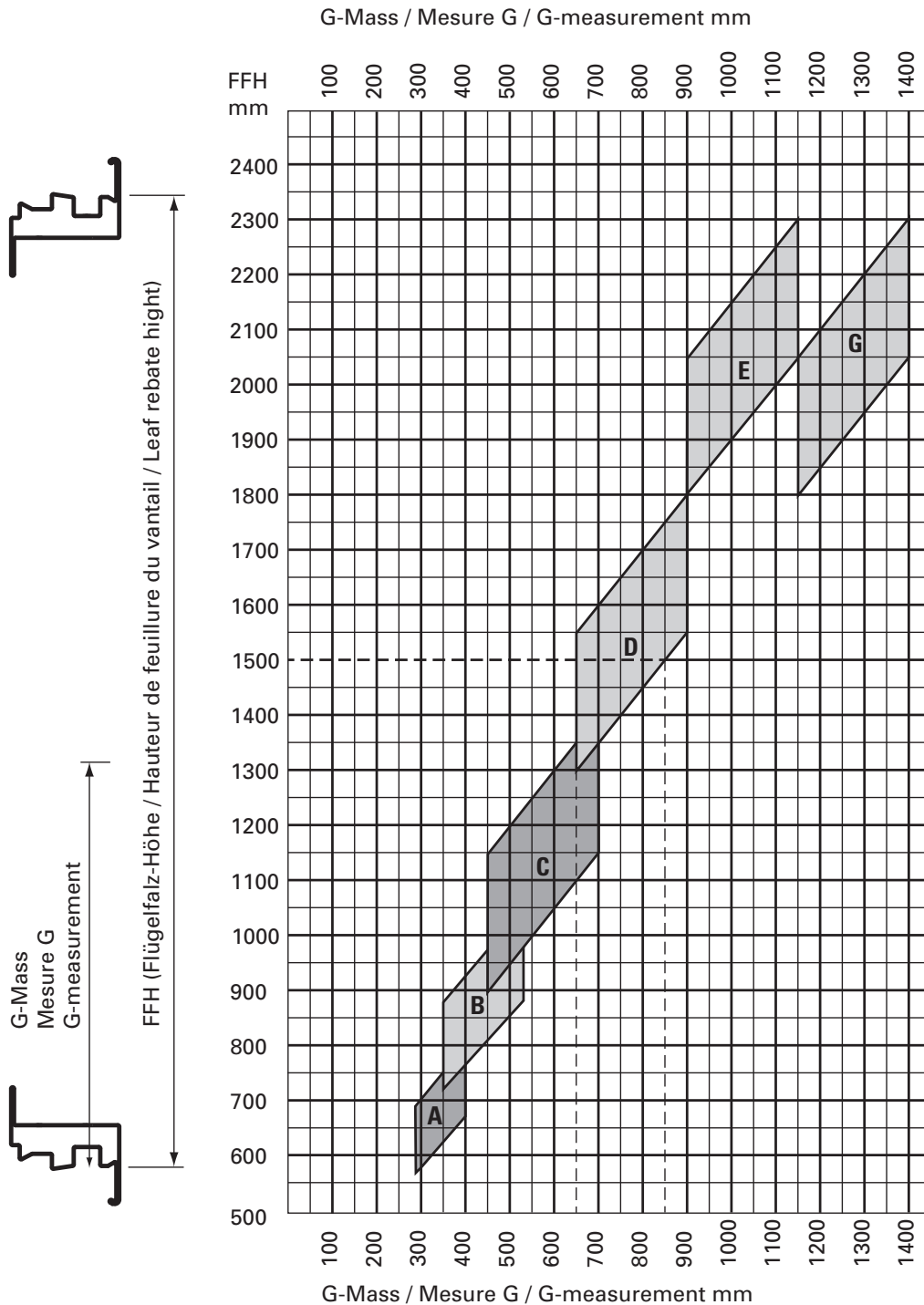

Beispiel:
 FFH 1500 mm
 G-Mass
 von 650 mm bis 850 mm

Exemple:
 FFH 1500 mm
 Mesure G de 650 mm à
 850 mm

Example:
 FFH 1500 mm
 G measurement from
 650 mm to 850 mm

- A Einbau Fehlschalt-
sicherung nicht möglich
- A Montage anti-fausse
manoeuvre pas possible
- A Installation fool-proof
mechanism not possible

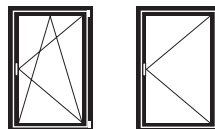
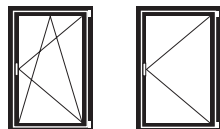
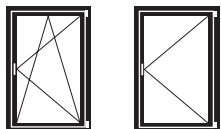

2. Basisbeschlag auswählen

2. Choisir paquet de base

2. Select basic kit

558.000

Basisbeschlag
Drehkipp-Beschlag Standard,
DIN links

VE = 1 Garnitur bestehend aus:

2 Eckumlenkung E1	599.402
1 Kippschliessblech SBK.S.9-18.J	599.484
2 Sicherheits-Schliessblech links SBS.S.9-18.J.LS	599.482
3 Stulpplatten ER J SL	599.425
1 Ecklager ESV 6-3-16 SL	599.428
1 Flügellager links FWSB 18-9 J LS SL	599.429
1 Flügellagerstopfen FWV SL	599.433
1 Scherenlager SL.K.3-6.130	599.443
1 Fehlschaltsicherung FSA	599.406
1 Auflauf	599.479
1 Mittenverriegelung MK.PA.250-1	599.417
1 Unterlage Ecklager	599.533

558.000

Paquet de base
Ferrure oscillo-battant Standard,
DIN gauche

UV = 1 garniture comprenant:

2 Renvoi d'angle E1	599.402
1 Gâche oscillo-battant SBK.S.9-18.J	599.484
2 Gâches de sécurité à gauche SBS.S.9-18.J.LS	599.482
3 Plaques ER J SL	599.425
1 Charnière inférieure d'angle ESV 6-3-16 SL	599.428
1 Fiche d'angle du vantail à gauche FWSB 18-9 J LS SL	599.429
1 Bouchon FWV SL	599.433
1 Charnière supérieur du ciseaux SL.K.3-6.130	599.443
1 Anti-fausse manoeuvre FSA	599.406
1 Appui	599.479
1 Verrouillage central MK.PA.250-1	599.417
1 Cale charnière d'angle	599.533

558.000

Basic kit
Standard turn/tilt fitting,
left-hand opening

PU = 1 set consisting of:

2 Corner guide E1	599.402
1 Tilt striking plate SBK.S.9-18.J	599.484
2 Security strike plate left SBS.S.9-18.J.LS	599.482
3 Connecting pieces ER J SL	599.425
1 Corner hinge part ESV 6-3-16 SL	599.428
1 Leaf hinge part left FWSB 18-9 J LS SL	599.429
1 Vent bearing stoppers FWV SL	599.433
1 Scissor hinge part SL.K.3-6.130	599.443
1 Fool-proof mechanism FSA	599.406
1 Lock staple	599.479
1 Central lock MK.PA.250-1	599.417
1 Support for corner pivot	599.533

Ansicht von innen (Bandseite)
Vue de l'intérieur (côté paumelle)
View from inside (hinge side)

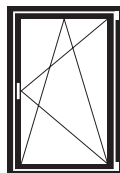
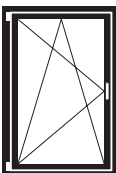

DIN links/gauche/left

DIN rechts/droite/right

558.001

Basisbeschlag
Drehkipp-Beschlag Standard,
DIN rechts

VE = 1 Garnitur bestehend aus:

2 Eckumlenkung E1	599.402
1 Kippschliessblech SBK.S.9-18.J	599.484
2 Sicherheits-Schliessblech rechts SBS.S.9-18.J.RS	599.483
3 Stulpplatten ER J SL	599.425
1 Ecklager ESV 6-3-16 SL	599.428
1 Flügellager rechts FWSB 18-9 J RS SL	599.430
1 Flügellagerstopfen FWV SL	599.433
1 Scherenlager SL.K.3-6.130	599.443
1 Fehlschaltsicherung FSA	599.406
1 Auflauf	599.479
1 Mittenverriegelung MK.PA.250-1	599.417
1 Unterlage Ecklager	599.533

558.001

Paquet de base
Ferrure oscillo-battante Standard,
DIN droite

UV = 1 garniture comprenant:

2 Renvoi d'angle E1	599.402
1 Gâche oscillo-battant SBK.S.9-18.J	599.484
2 Gâches de sécurité à droite SBS.S.9-18.J.RS	599.483
3 Plaques ER J SL	599.425
1 Charnière inférieure d'angle ESV 6-3-16 SL	599.428
1 Fiche d'angle du vantail à droite FWSB 18-9 J RS SL	599.430
1 Bouchon FWV SL	599.433
1 Charnière supérieur du ciseaux SL.K.3-6.130	599.443
1 Anti-fausse manoeuvre FSA	599.406
1 Appui	599.479
1 Verrouillage central MK.PA.250-1	599.417
1 Cale charnière d'angle	599.533

558.001

Basic kit
Standard turn/tilt fitting,
right-hand opening

PU = 1 set consisting of:

2 Corner guide E1	599.402
1 Tilt striking plate SBK.S.9-18.J	599.484
2 Security strike plate right SBS.S.9-18.J.RS	599.483
3 Connecting pieces ER J SL	599.425
1 Corner hinge part ESV 6-3-16 SL	599.428
1 Leaf hinge part right FWSB 18-9 J RS SL	599.430
1 Vent bearing stoppers FWV SL	599.433
1 Scissor hinge part SL.K.3-6.130	599.443
1 Fool-proof mechanism FSA	599.406
1 Lock staple	599.479
1 Central lock MK.PA.250-1	599.417
1 Support for corner pivot	599.533

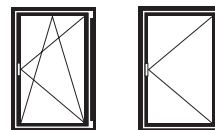
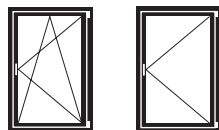
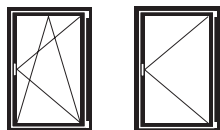

**3. Grössenabhängige
 Beschlagteile auswählen**

**3. Choisir les ferrures en
 fonction de la dimension**

**3. Select fittings
 depending on size**

Breite

Largeur

Width

FFB mm	Oberschiene Tringle supérieure Top rod	Eckumlenkung Renvoi d'angle Corner guide	Mittenverriegelung unten Verrouillage central inférieur Central lock bottom	Schliessblech Gâche Strike plate	Schere Compas Stay
370 - 600	1 x 599.434 OS1.600	1 x 599.404 E3			1 x 599.439*/440** SK1.18-9.xx
600 - 775	1 x 599.435 OS2.800	1 x 599.403 E2			1 x 599.441*/442** SK2.18-9.xx
776 - 1025	1 x 599.436 OS2.1025-1	1 x 599.403 E2		1 x 599.482*/483** SBS.S.9-18.J.xx	1 x 599.441*/442** SK2.18-9.xx
1026 - 1250	1 x 599.437 OS2.1250-1	1 x 599.403 E2		1 x 599.482*/483** SBS.S.9-18.J.xx	1 x 599.441*/442** SK2.18-9.xx
1251 - 1475	1 x 599.438 OS2.1475-1	1 x 599.403 E2	1 x 599.416 MK.750-1	2 x 599.482*/483** SBS.S.9-18.J.xx	1 x 599.441*/442** SK2.18-9.xx

Höhe Getriebeseite

Hauteur côté crémons

Height mechanism side

FFH mm		Getriebe Crémone Mechanism	G-Mass Mesure G G-measurement mm	Mittenverriegelung unten Verrouillage central inférieur Central lock bottom	Schliessblech Gâche Strike plate
575 - 800	A	1 x 599.407 GAM.800.D7,5	288 - 400		
711 - 1050	B	1 x 599.408 GAM.1050-1.D7,5	355 - 525		1 x 599.482*/483** SBS.S.9-18.J.xx
901 - 1400	C	1 x 599.409 GAM.1400-1.D7,5	450 - 700		1 x 599.482*/483** SBS.S.9-18.J.xx
1301 - 1800	D	1 x 599.410 GAM.1800-2.D7,5	650 - 900		2 x 599.482*/483** SBS.S.9-18.J.xx
1801 - 2300	E	1 x 599.411 GAM.2300-3.D7,5	900 - 1150		3 x 599.482*/483** SBS.S.9-18.J.xx
1801 - 2300	G	1 x 599.410 GAM1800-2.D7,5	1150 - 1400	1 x 599.414 MK.500-0	2 x 599.482*/483** SBS.S.9-18.J.xx

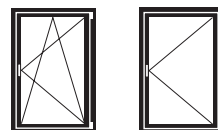
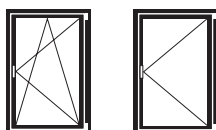
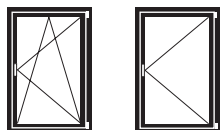

Höhe Bandseite

Hauteur côté paumelle

Height hinge side

FFH mm	Mittenverriegelung Verrouillage central Central lock	Schliessblech Gâche Strike plate
1301 - 2000	1 x 599.416 MK.750-1	1 x 599.482*/483** SBS.S.9-18.J.xx
2001 - 2300	2 x 599.416 MK.750-1	2 x 599.482*/483** SBS.S.9-18.J.xx

* links / ** rechts

* à gauche / ** à droite

* left / ** right

4. Befestigungsmaterial auswählen

4. Choisir le matériel de fixation

4. Select fixing material

Schraubenbedarf

Ungefähre Anzahl Schrauben pro Flügel:

557.045 ca. 60 Schrauben
557.046 ca. 10 Schrauben

Besoins en vis

Nombre approximatif de vis par vantail:

557.045 env. 60 vis
557.046 env. 10 vis

Screws required

Approximate number of screws per vent:

557.045 approx. 60 screws
557.046 approx. 10 screws

Beschlagsunterlagen

557.050 ca. 20 Stück

Cale

557.050 env. 20 pièces

Mechanism support

557.050 approx. 20 pieces

5. Fenstergriffe auswählen

siehe Seite 40

5. Choisir la poignée

voir page 40

5. Select handle

see page 40

6. Zusätzliche Beschläge auswählen

siehe Seite 42

6. Choisir des ferrures supplémentaires

voir page 42

6. Select additional fittings

see page 42

Legende Dreh- und
 Drehkippbeschlag Standard

Légende ferrure oscillo-battante
 et à la française Standard

Key to Standard turn/tilt and
 side-hung fitting

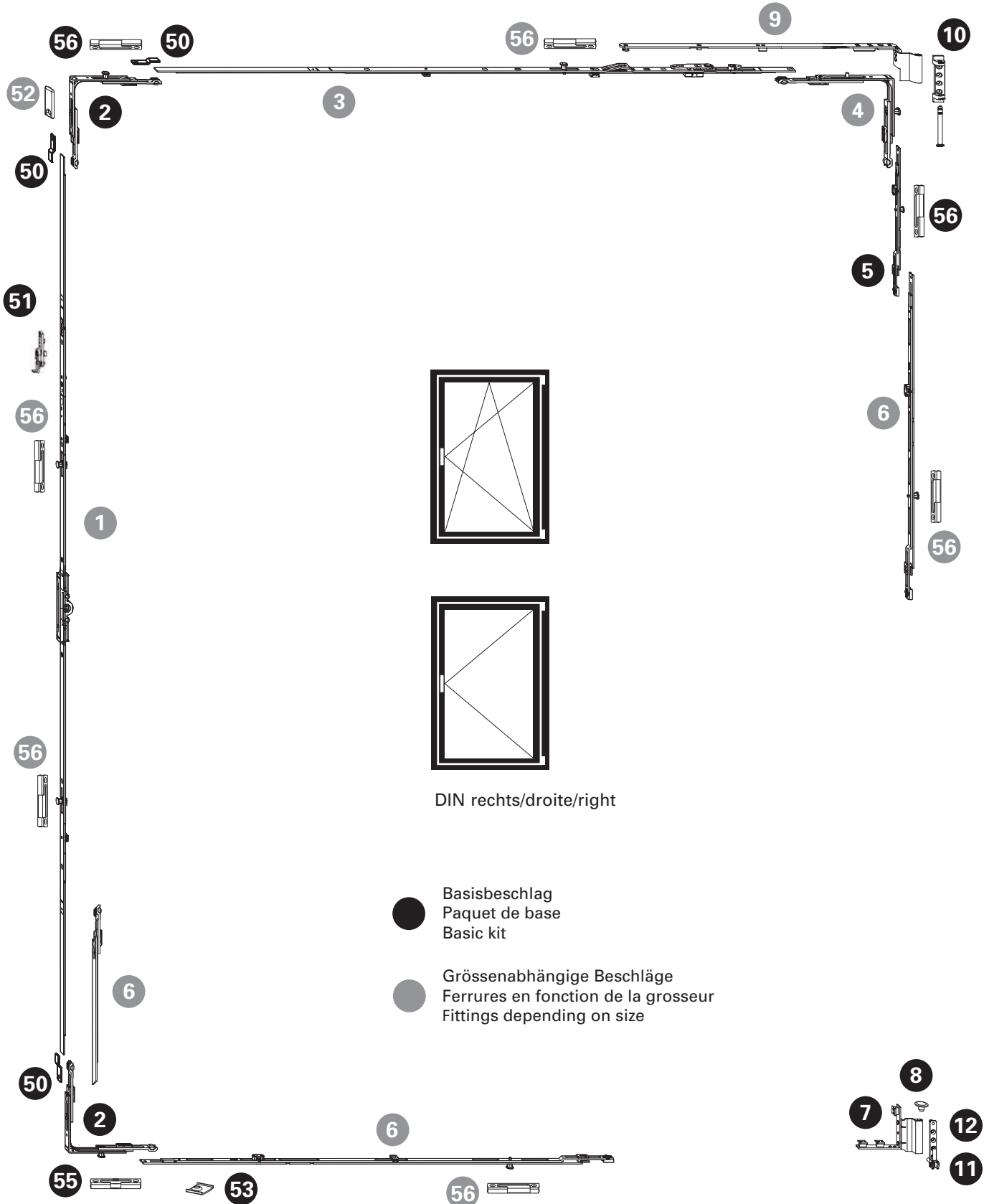

DIN rechts/droite/right

- Basisbeschlag
Paquet de base
Basic kit
- Größenabhängige Beschläge
Ferrures en fonction de la grosseur
Fittings depending on size

Drehkipp- und Drehbeschlag
Ferrure oscillo-battante et à la française
Turn/tilt and side-hung fitting

Jansen-Economy 50 Fenster
 Jansen-Economy 50 fenêtres
 Jansen-Economy 50 windows

Pos.	Beschrieb Description Description	Kennzeichnung Désignation Designation	Einsatz Utilisable Suitable	Bohrlehre Gabarit de perçage Drilling jig	Artikel-Nr No d'article Part no.
1	Getriebeschiene Crémone de tringle Mechanism rod	GAM.800.D.7,5 GAM.1050-1.D.7,5 GAM.1400-1.D.7,5 GAM.1800-2.D.7,5 GAM.2300-3.D.7,5	FFH 575 - 800 FFH 711 - 1050 FFH 901 - 1400 FFH 1301 - 2300 FFH 1801 - 2300	499.451 G.A G.B G.C G.D G.E	599.407 599.408 599.409 599.410 599.411
2	Eckmülnkung Renvoi d'angle Corner guide	E1		499.456 E	599.402
3	Oberschiene Tringle supérieure Top rod	OS1.600 OS2.800 OS2.1025-1 OS2.1250-1 OS2.1475-1	FFB 370 - 600 FFB 600 - 775 FFB 776 - 1025 FFB 1026 - 1250 FFB 1251 - 1475	499.454 O.A O.B O.C O.D O.E	599.434 599.435 599.436 599.437 599.438
4	Eckmülnkung Renvoi d'angle Corner guide	E2 E3		499.456 E	599.403 599.404
5	Mittenverriegelung Verrouillage central Central lock	MK.PA.250-1		499.453 M.B	599.417
6	Mittenverriegelung Verrouillage central Central lock	MK.750-1 MK.750-1/MK.500-1 MK.500-0	ab/dès/from FFB 1251 ab/dès/from FFB 1301 ab/dès/from FFB 1801	499.453 M.D M.D / M.C M.C	599.416 599.416/415 599.414
7	Flügelager Fiche d'angle du vantail Leaf hinge part	FWSB 18-9 J LS SL FWSB 18-9 J RS SL	links/à gauche/left rechts/à droite/right	499.456 F F	599.429 599.430
8	Flügelagerstopfen Bouchon Vent bearing stoppers	FWV SL			599.433
9	Schere Compas Stay	SK.1.18-9.RS SK.1.18-9.RS SK.2.18-9.LS SK.2.18-9.RS	links/à gauche/left rechts/à droite/right links/à gauche/left rechts/à droite/right		599.439 599.440 599.441 599.442
10	Scherenlager Charnière supérieure du ciseaux Scissor hinge part	SL.K.3-6.130		499.455 E	599.443
11	Ecklager Charnière inférieure d'angle Corner hinge part	ESV 6-3-16 SL		499.455 E	599.428
12	Unterlage Ecklager (nicht notwendig) Cale charnière d'angle (pas nécessaire) Support for corner pivot (not necessary)				599.533
50	Stulpplatte Plaque Connecting piece	ER J SL			599.425
51	Fehlschaltssicherung Anti-fausse manoeuvre Fool-proof mechanism	FSA			599.406
52	Anschlagplatte/Plaque-butée/Stop plate AWDR				599.400
53	Auflauf Appui Lock staple				599.479
55	Kippschliessblech Gâche oscillo-battante Tilt striking plate	SBK.S.9-18.J		499.459 S.A	599.484
56	Sicherheitsschliessblech Gâche de sécurité Security strike plate	SBS.S.9-18.J.LS SBS.S.9-18.J.RS	links/à gauche/left rechts/à droite/right	499.459 S.A	599.482 599.483
60	Schraube / Vis / Screw M4x20				557.045
61	Schraube / Vis / Screw M4x12				557.046
63	Beschlagsunterlage / Cale / Mechanism support				557.050

Bestellschema Stulp-Beschlag (Standflügel)

Tableau de commande ferrure pour fenêtre à deux vantaux (vantaill semi-fixe)

Order chart fitting for double leaf window (secondary leaf)

Jansen-Economy 50 Fenster

Jansen-Economy 50 fenêtres

Jansen-Economy 50 windows

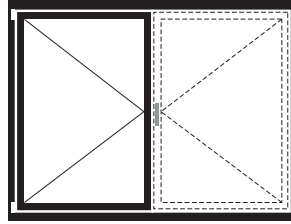
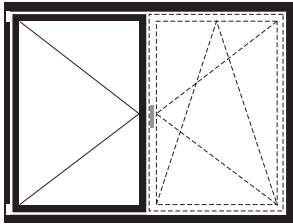

**Stulp-Beschlag
(Standflügel)**

**Ferrure pour fenêtre
à deux vantaux
(Vantaill semi-fixe)**



Stulp-Beschlag (Standflügel)**Ferrure pour fenêtre à deux vantaux (vantail semi-fixe)****Fitting for double leaf window (secondary leaf)**

Jansen-Economy 50 Fenster

Jansen-Economy 50 fenêtres

Jansen-Economy 50 windows

1. FFH, FFB, G-Mass, Stulpgetriebe und Öffnungsrichtung bestimmen**1. Choisir FFH, FFB, la mesure G, crémonne de vantail semi-fixe et l'orientation de l'ouverture****1. Determine the vent rebate height (FFH), vent rebate width (FFB), double-vent gearbox, G measurement and opening direction**

Das Stulpgetriebe wird in Abhängigkeit der Getriebebeschiene des erstöffnenden Flügels ausgewählt. Hierbei kommt folgende Tabelle zum Einsatz:

La tige de crémonne de vantail semi-fixe est sélectionnée en fonction de la crémonne de tringle du vantail ouvrant en premier. Utiliser le tableau suivant:

The track for double-leaf windows is to be selected per the operating rod of the wing which opens first. The following table is used for this:

Getriebebeschiene Öffnungsflügel Crémone de tringle vantail principal Mechanism rod opening leaf	definiert Stulpgetriebe définit la crémonne de vantail semi-fixe defined double-vent gearbox
599.407 GAM.800-D7,5	Balkontürschnäpper 599.401 / Schnäpperbolzen 599.419 Loqueteau pour porte de balcon 599.401 / Goujon d'encliquetage 599.419 Balcony door catch 599.401 / Bolt for spring-loaded catch 599.419
599.408 GAM.1050-1.D7,5	599.421 GASM.1050-1.E3
599.409 GAM.1400-1.D7,5	599.422 GASM.1400-1
599.410 GAM.1800-2.D7,5	599.423 GASM.1800-2
599.411 GAM.2300-3.D7,5	599.424 GASM.2300-3

Stulp-Beschlag (Standflügel)

Ferrure pour fenêtre à deux vantaux (vantaill semi-fixe)

Fitting for double leaf window (secondary leaf)

Jansen-Economy 50 Fenster

Jansen-Economy 50 fenêtres

Jansen-Economy 50 windows

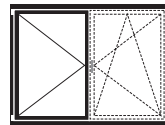
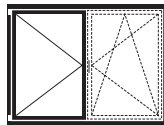
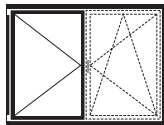

2. Basisbeschlag auswählen

2. Choisir paquet de base

2. Select basic kit

558.002

Basisbeschlag
Stulp-Beschlag (Standflügel)
Standard,
DIN links

VE = 1 Garnitur bestehend aus:

2 Eckumlenkung E1	599.402
1 Kippschliessblech SBK.S.9-18.J	599.484
1 Sicherheits-Schliessblech links SBS.S.9-18.J.LS	599.482
2 Stulpplatten ER J SL	599.425
1 Drehlager links DL.K.ET.18-9.LS	599.426
1 Ecklager ESV 6-3-16 SL	599.428
1 Flügellager links FWSB 18-9 J LS SL	599.429
1 Flügellagerstopfen FWV SL	599.433
1 Scherenlager SL.K.3-6.130	599.443
1 Auflauf	599.479
1 Unterlage Ecklager	599.533

558.002

Paquet de base
Ferrure pour fenêtre à deux vantaux
(vantaill semi-fixe) Standard,
DIN gauche

UV = 1 garniture comprenant:

2 Renvoi d'angle E1	599.402
1 Gâche oscillo-battant SBK.S.9-18.J	599.484
1 Gâches de sécurité à gauche SBS.S.9-18.J.LS	599.482
2 Plaques ER J SL	599.425
1 Compas à gauche DL.K.ET.18-9.LS	599.426
1 Charnière inférieure d'angle ESV 6-3-16 SL	599.428
1 Fiche d'angle du vantaill à gauche FWSB 18-9 J LS SL	599.429
1 Bouchon FWV SL	599.433
1 Charnière supérieur du ciseaux SL.K.3-6.130	599.443
1 Appui	599.479
1 Cale charnière d'angle	599.533

558.002

Basic kit
Standard fitting for double leaf
window (secondary leaf),
left-hand opening

PU = 1 set consisting of:

2 Corner guide E1	599.402
1 Tilt striking plate SBK.S.9-18.J	599.484
1 Security strike plate left SBS.S.9-18.J.LS	599.482
2 Connecting pieces ER J SL	599.425
1 Pivot hinge left DL.K.ET.18-9.LS	599.426
1 Corner hinge part ESV 6-3-16 SL	599.428
1 Leaf hinge part left FWSB 18-9 J LS SL	599.429
1 Vent bearing stoppers FWV SL	599.433
1 Scissor hinge part SL.K.3-6.130	599.443
1 Lock staple	599.479
1 Support for corner pivot	599.533

Ansicht von innen (Bandseite)

Vue de l'intérieur (côté paumelle)

View from inside (hinge side)

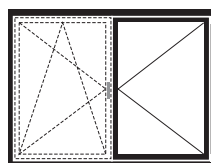
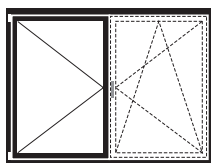

DIN links/gauche/left

DIN rechts/droite/right

Stulp-Beschlag (Standflügel)**Ferrure pour fenêtre à deux vantaux (vantail semi-fixe)****Fitting for double leaf window (secondary leaf)**

Jansen-Economy 50 Fenster

Jansen-Economy 50 fenêtres

Jansen-Economy 50 windows

558.003**Basisbeschlag
Stulp-Beschlag (Standflügel)
Standard,
DIN rechts**

VE = 1 Garnitur bestehend aus:

2 Eckumlenkung E1	599.402
1 Kippschliessblech SBK.S.9-18.J	599.484
1 Sicherheits-Schliessblech rechts SBS.S.9-18.J.RS	599.483
2 Stulpplatten ER J SL	599.425
1 Drehlager rechts DL.K.ET.18-9.RS	599.427
1 Ecklager ESV 6-3-16 SL	599.428
1 Flügellager rechts FWSB 18-9 J RS SL	599.430
1 Flügellagerstopfen FWV SL	599.433
1 Scherenlager SL.K.3-6.130	599.443
1 Auflauf	599.479
1 Unterlage Ecklager	599.533

558.003**Paquet de base
Ferrure pour fenêtre à deux vantaux
(vantail semi-fixe) Standard,
DIN droite**

UV = 1 garniture comprenant:

2 Renvoi d'angle E1	599.402
1 Gâche oscillo-battant SBK.S.9-18.J	599.484
1 Gâches de sécurité à droite SBS.S.9-18.J.RS	599.483
2 Plaques ER J SL	599.425
1 Compas à droite DL.K.ET.18-9.RS	599.427
1 Charnière inférieure d'angle ESV 6-3-16 SL	599.428
1 Fiche d'angle du vantail à droite FWSB 18-9 J RS SL	599.430
1 Bouchon FWV SL	599.433
1 Charnière supérieur du ciseaux SL.K.3-6.130	599.443
1 Appui	599.479
1 Cale charnière d'angle	599.533

558.003**Basic kit
Standard fitting for double leaf
window (secondary leaf),
right-hand opening**

PU = 1 set consisting of:

2 Corner guide E1	599.402
1 Tilt striking plate SBK.S.9-18.J	599.484
1 Security strike plate right SBS.S.9-18.J.RS	599.483
2 Connecting pieces ER J SL	599.425
1 Pivot hinge right DL.K.ET.18-9.RS	599.427
1 Corner hinge part ESV 6-3-16 SL	599.428
1 Leaf hinge part right FWSB 18-9 J RS SL	599.430
1 Vent bearing stoppers FWV SL	599.433
1 Scissor hinge part SL.K.3-6.130	599.443
1 Lock staple	599.479
1 Support for corner pivot	599.533

Stulp-Beschlag (Standflügel)**Ferrure pour fenêtre à deux vantaux (vantail semi-fixe)****Fitting for double leaf window (secondary leaf)**

Jansen-Economy 50 Fenster

Jansen-Economy 50 fenêtres

Jansen-Economy 50 windows

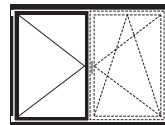
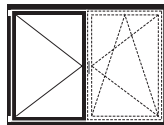
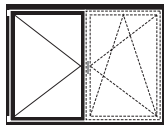
**3. Grössenabhängige
Beschlagteile auswählen****3. Choisir les ferrures en
fonction de la dimension****3. Select fittings
depending on size****Breite****Largeur****Width**

FFB mm	Mittenverriegelung Verrouillage central Central lock	Schliessblech Gâche Strike plate
370 - 1250		
1251 - 1475	2 x 599.416 MK.750-1	2 x 599.482*/483** SBS.S.9-18.J.xx

* links / ** rechts

* à gauche / ** à droite

* left / ** right

Höhe**Hauteur****Height**

FFH mm	Stulpgetriebe Crémone de vantail semi-fixe Double-vent gearbox	G-Mass Drehkipppflügel Mesure G Vantail oscillo-battant G-measurement turn/tilt window	Mittenverriegelung unten Verrouillage central inférieur Central lock bottom	Zwangsverriegelung Verrouillage forcé Security locking system
575 - 880	1 x 599.401 BK SL 1 x 599.419 BK-FC SL	288 - 440		
881 - 1050	1 x 599.421 GASM.1050-1.E3	440 - 525		
901 - 1400	1 x 599.422 GASM.1400-1	450 - 700		1 x 599.444 ZV-RT.H.9-20.AGR 1 x 599.445 ZV-FT SL
1301 - 1800	1 x 599.423 GASM.1800-2	650 - 900		1 x 599.444 ZV-RT.H.9-20.AGR 1 x 599.445 ZV-FT SL
1801 - 2300	1 x 599.424 GASM.2300-3	900 - 1150		2 x 599.444 ZV-RT.H.9-20.AGR 2 x 599.445 ZV-FT SL
1801 - 2300	1 x 599.423 GASM.1800-2	1150 - 1400	1 x 599.414 MK.500-0	2 x 599.444 ZV-RT.H.9-20.AGR 2 x 599.445 ZV-FT SL

Stulp-Beschlag (Standflügel)

Ferrure pour fenêtre à deux vantaux (vantaux semi-fixe)

Fitting for double leaf window (secondary leaf)

Jansen-Economy 50 Fenster

Jansen-Economy 50 fenêtres

Jansen-Economy 50 windows

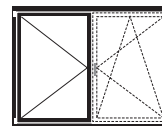
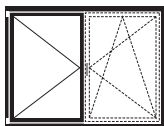
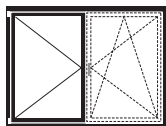

4. Befestigungsmaterial auswählen

Schraubenbedarf

Ungefähre Anzahl Schrauben pro Flügel:

557.045 ca. 60 Schrauben

557.046 ca. 10 Schrauben

Beschlagsunterlagen

557.050 ca. 20 Stück

5. Zusätzliche Beschläge auswählen

siehe Seite 42

4. Choisir le matériel de fixation

Besoins en vis

Nombre approximatif de vis par vantaux:

557.045 env. 60 vis

557.046 env. 10 vis

Cale

557.050 env. 20 pièces

5. Choisir des ferrures supplémentaires

voir page 42

4. Select fixing material

Screws required

Approximate number of screws per vent:

557.045 approx. 60 screws

557.046 approx. 10 screws

Mechanism support

557.050 approx. 20 pieces

5. Select additional fittings

see page 42

Stulp-Beschlag (Standflügel)

Ferrure pour fenêtre à deux vantaux (vantail semi-fixe)

Fitting for double leaf window (secondary leaf)

Jansen-Economy 50 Fenster

Jansen-Economy 50 fenêtres

Jansen-Economy 50 windows

Legende Stulpbeschlag Standard

Légende ferrure pour fenêtre à deux vantaux Standard

Key to Standard fitting for double leaf window

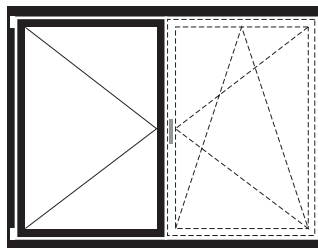
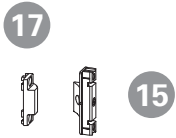
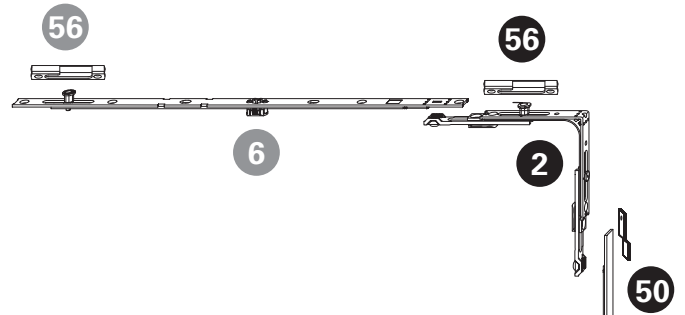
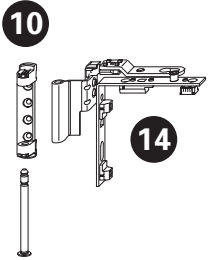

DIN links/gauche/left

● Basisbeschlag
Paquet de base
Basic kit

● Größenabhängige Beschläge
Ferrures en fonction de la grosseur
Fittings depending on size

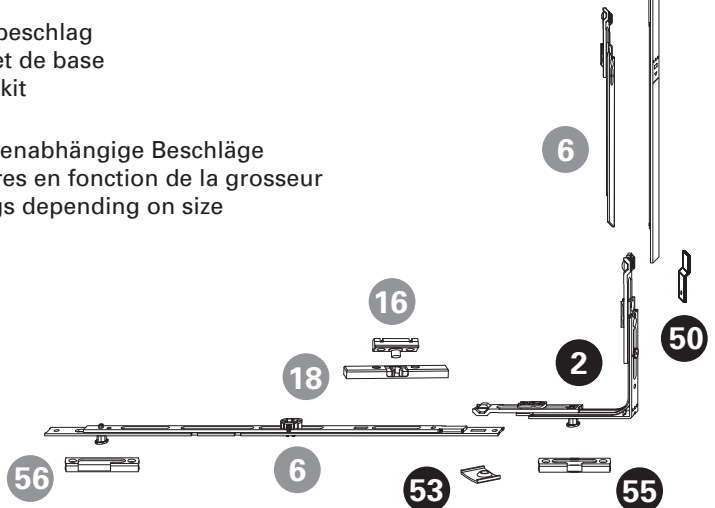
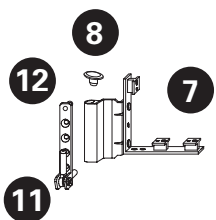

Stulp-Beschlag (Standflügel)
Ferrure pour fenêtre à deux vantaux (vantaïl semi-fixe)
Fitting for double leaf window (secondary leaf)

Jansen-Economy 50 Fenster
Jansen-Economy 50 fenêtres
Jansen-Economy 50 windows

Pos.	Beschrieb Description Description	Kennzeichnung Désignation Designation	Einsatz Utilisable Suitable	Bohrlehre Gabarit de perçage Drilling jig	Artikel-Nr No d'article Part no.
2	Eckumlenkung Renvoi d'angle Corner guide	E1		499.456 E	599.402
6	Mittenverriegelung Verrouillage central Central lock	MK.750-1 MK.500-0	ab/dès/from FFB 1251 ab/dès/from FFH 1801	499.453 M.D M.C	599.416 599.414
7	Flügelager Fiche d'angle du vantaïl Leaf hinge part	FWSB 18-9 J LS SL FWSB 18-9 J RS SL	links/à gauche/left rechts/à droite/right	499.456 F F	599.429 599.430
8	Flügelagerstopfen Bouchon Vent bearing stoppers	FWV SL			599.433
10	Scherenlager Charnière supérieure du ciseaux Scissor hinge part	SL.K.3-6.130		499.455 E	599.443
11	Ecklager Charnière inférieure d'angle Corner hinge part	ESV 6-3-16 SL		499.455 E	599.428
12	Unterlage Ecklager (nicht notwendig) Cale charnière d'angle (pas nécessaire) Support for corner pivot (not necessary)				599.533
13	Stulpgetriebe Crémone de vantaïl semi-fixe Double-vent gearbox	GASM.1050-1.E3 GASM.1400-1 GASM.1800-2 GASM.2300-3	FFH 881 - 1050 FFH 901 - 1400 FFH 1301 - 2300 FFH 1801 - 2300	499.452 S.B S.C S.D S.E	599.421 599.422 599.423 599.424
14	Drehlager Compas Pivot hinge	DL.K.ET.18-9-LS DL.K.ET.18-9-RS	links/à gauche/left rechts/à droite/right	499.457 D D	599.426 599.427
15	Zwangsverriegelung Verrouillage forcé Security locking system	ZV-FT SL	ab/dès/from FFH 901	499.458 Z.A	599.445
16	Schnäpperbolzen Goujon d'encliquetage Bolt for spring-loaded catch	BK-FC SL	bis FFH 880 jusqu'à FFH 880 up to FFH 880	499.458 B.A	599.419
17	Schliessblech Gâche Strike plate	ZV-RT.H.9-20.AGR	ab/dès/from FFH 901	499.462 Z.A	599.444
18	Balkontürschnäpper Loqueteau pour porte de balcon Balcony door catch	BK-SL	bis FFH 880 jusqu'à FFH 880 up to FFH 880	499.462 B.C	599.401
50	Stulpplatte Plaque Connecting piece	ER J SL			599.425
53	Auflauf Appui Lock staple				599.479
55	Kippschliessblech Gâche oscillo-battante Tilt striking plate	SBK.S.9-18.J		499.459 S.A	599.484
56	Sicherheitsschliessblech Gâche de sécurité Security strike plate	SBS.S.9-18.J.LS SBS.S.9-18.J.RS	links/à gauche/left rechts/à droite/right	499.459 S.A	599.482 599.483
60	Schraube / Vis / Screw M4x20				557.045
61	Schraube / Vis / Screw M4x12				557.046
63	Beschlagsunterlage / Cale / Mechanism support				557.050

JC Decaux, Madrid/ES (Architekt: Carlos Ferrater, Barcelona/ES)



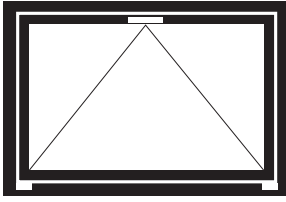

Kippbeschlag Ferrure à soufflet



Für die Bestellung der Fensterbeschläge benutzen Sie bitte die InForm 2/2017. In dieser finden Sie die neue Artikelnummern Logik für die Komplettverpackungen der Beschläge nach der bestellt werden kann. Janisoft benutzt beim Materialauszug ebenfalls diese Systematik.

En ce qui concerne la commande des ferrures de fenêtre, utilisez s'il vous plait l'InForm 2/2017. Dans celui-ci vous trouverez la logique des nouveaux numéros d'article pour les emballages complets des ferrures d'après vous pouvez commander. La liste de matériel du Janisoft utilise déjà cette systématique.

Please use the InForm 2/2017 for the order process of the window fittings. It shows the logic of the item numbers for the new complete packaging of the fittings, needed for the order. The new system is in the Janisoft software as well implemented.

1. FFB, FFH und G-Mass bestimmen

1. Choisir FFB, FFH et la mesure G

1. Determine the vent rebate width (FFB), the vent rebate height (FFH) and G measurement

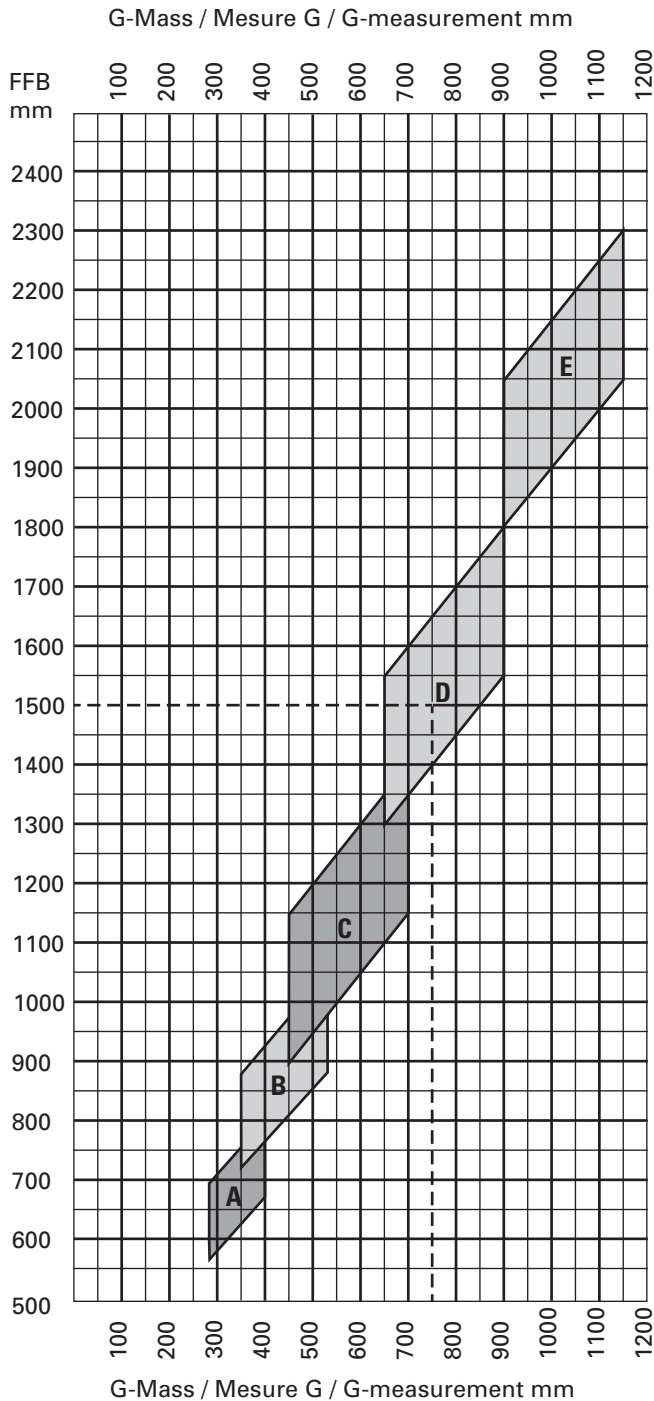

G-Mass bei Kippflügel immer mittig wählen.

Beispiel:
 FFB 1500 mm
 G-Mass 750 mm

Toujours choisir la mesure G centrée pour le vantail à soufflet.

Exemple:
 FFB 1500 mm
 Mesure G 750 mm

For the G measurement of bottom-hung vents, always select the value in the middle

Example:
 FFB 1500 mm
 G measurement 750 mm

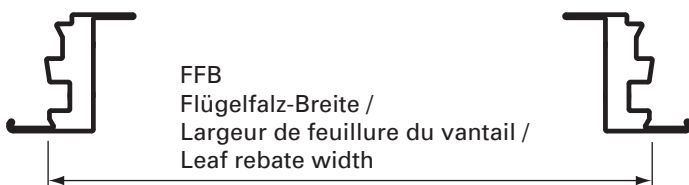

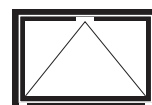
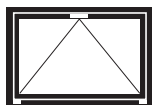
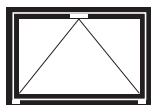

2. Basisbeschlag auswählen

2. Choisir paquet de base

2. Select basic kit

558.004

Basisbeschlag Kippbeschlag Standard

VE = 1 Garnitur bestehend aus:

1 Anschlagplatte AWDR SL	599.400
2 Eckumlenkung E1	599.402
2 Sicherheits-Schliessblech links SBS.S.9-18.J.LS	599.482
2 Stulpplatten ER J SL	599.425
2 Scherenlager SL.K.3-6.130	599.443
2 Kippband KB.K.18-9	599.454
2 Unterlagen Ecklager	599.533

558.004

Paquet de base Ferrure à soufflet Standard

UV = 1 garniture comprenant:

1 Plaque-butée AWDR SL	599.400
2 Renvoi d'angle E1	599.402
2 Gâches de sécurité à gauche SBS.S.9-18.J.LS	599.482
2 Plaques ER J SL	599.425
2 Charnière supérieur du ciseaux SL.K.3-6.130	599.443
2 Paumelles soufflet KB.K.18-9	599.454
2 Cale charnière d'angle	599.533

558.004

Basic kit Standard bottom-hung fitting

PU = 1 set consisting of:

1 Stop plate AWDR SL	599.400
2 Corner guide E1	599.402
2 Security strike plate left SBS.S.9-18.J.LS	599.482
2 Connecting pieces ER J SL	599.425
2 Scissor hinge part SL.K.3-6.130	599.443
2 Tilt hinges KB.K.18-9	599.454
2 Support for corner pivot	599.533

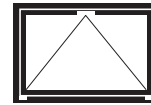
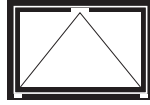
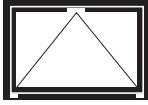

**3. Grössenabhängige
 Beschlagsteile auswählen**

**3. Choisir les ferrures en
 fonction de la dimension**

**3. Select fittings
 depending on size**

Breite

Largeur

Width

FFB mm		Getriebe Crémone Mechanism	G-Mass Mesure G G-measurement mm	Kippflügelband Scherenlager Paumelle fenêtre à soufflet Charnière supérieure du ciseaux Bottom-hung hinge Scissor hinge part	Schliessblech Gâche Strike plate
575 - 800	A	1 x 599.407 GAM.800.D7,5	288 - 400	> 80 kg 1 x 557.216 KB.K.18-9, SL.K.3-6.130	
711 - 1050	B	1 x 599.408 GAM.1050-1.D7,5	355 - 525	> 80 kg 1 x 557.216 KB.K.18-9, SL.K.3-6.130	1 x 599.482 SBS.S.9-18.J.xx
901 - 1400	C	1 x 599.409 GAM.1400-1.D7,5	450 - 700	1 x 557.216 KB.K.18-9, SL.K.3-6.130	1 x 599.482 SBS.S.9-18.J.xx
1301 - 1800	D	1 x 599.410 GAM.1800-2.D7,5	650 - 900	1 x 557.216 KB.K.18-9, SL.K.3-6.130	2 x 599.482 SBS.S.9-18.J.xx
1801 - 2300	E	1 x 599.411 GAM.2300-3.D7,5	900 - 1150	1 x 557.216 KB.K.18-9, SL.K.3-6.130	3 x 599.482 SBS.S.9-18.J.xx

Höhe

Hauteur

Height

FFH mm	Mittenverriegelung Verrouillage central Central lock	Schliessblech Gâche Strike plate	Falzschere Compas d'arrêt Rebate stay
370 - 1300			2 x 557.219 FSR SL, BK F.SCHN.B.SL
1301 - 1800	2 x 599.416 MK.750-1	2 x 599.482 SBS.S.9-18.J.xx	2 x 599.405 FSR SL
1801 - 2300	4 x 599.416 MK.750-1	4 x 599.482 SBS.S.9-18.J.xx	2 x 599.405 FSR SL

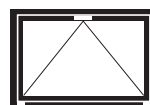
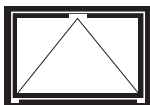
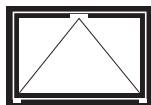

4. Befestigungsmaterial auswählen

Schraubenbedarf

Ungefähre Anzahl Schrauben pro Flügel:

557.045 ca. 60 Schrauben

557.046 ca. 10 Schrauben

557.048 ca. 2 Schrauben

Beschlagsunterlagen

557.050 ca. 20 Stück

5. Fenstergriffe auswählen

siehe Seite 40

6. Zusätzliche Beschläge auswählen

siehe Seite 42

4. Choisir le matériel de fixation

Besoins en vis

Nombre approximatif de vis par vantail:

557.045 env. 60 vis

557.046 env. 10 vis

557.048 env. 2 vis

Cale

557.050 env. 20 pièces

5. Choisir la poignée

voir page 40

6. Choisir des ferrures supplémentaires

voir page 42

4. Select fixing material

Screws required

Approximate number of screws per vent:

557.045 approx. 60 screws

557.046 approx. 10 screws

557.048 approx. 2 screws

Mechanism support

557.050 approx. 20 pieces

5. Select handle

see page 40

6. Select additional fittings

see page 42

Legende Kippbeschlag Standard

Légende ferrure à soufflet Standard

Key to Standard bottom-hung window

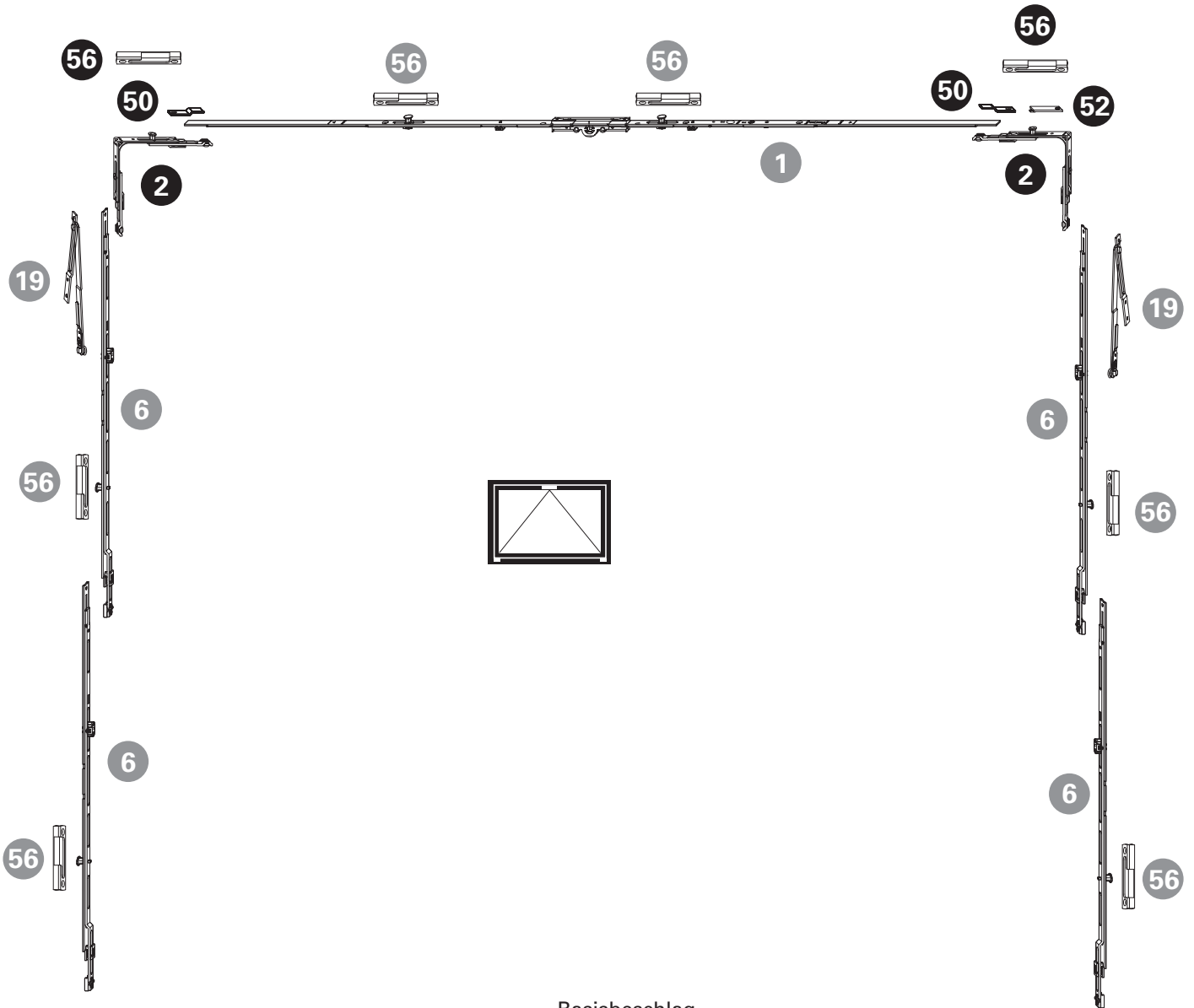

- Basisbeschlag
Paquet de base
Basic kit
- Größenabhängige Beschläge
Ferrures en fonction de la grosseur
Fittings depending on size

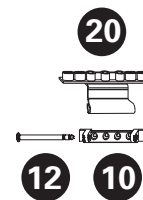
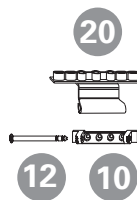
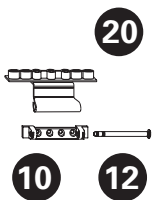

Kippbeschlag
Ferrure à soufflet
Bottom-hung fitting

Jansen-Economy 50 Fenster
Jansen-Economy 50 fenêtres
Jansen-Economy 50 windows

Pos.	Beschrieb Description Description	Kennzeichnung Désignation Designation	Einsatz Utilisable Suitable	Bohrlehre Gabarit de perçage Drilling jig	Artikel-Nr No d'article Part no.
1	Getriebeschiene Crémone de tringle Mechanism rod	GAM.800.D.7,5 GAM.1050-1.D.7,5 GAM.1400-1.D.7,5 GAM.1800-2.D.7,5 GAM.2300-3.D.7,5	FFB 575 - 800 FFB 711 - 1050 FFB 901 - 1400 FFB 1301 - 2300 FFB 1801 - 2300	499.451 G.A G.B G.C G.D G.E	599.407 599.408 599.409 599.410 599.411
2	Eckumlenkung Renvoi d'angle Corner guide	E1		499.456 E	599.402
6	Mittenverriegelung Verrouillage central Central lock	MK.750-1 MK.750-1/MK.500-1	ab/dès/from FFH 1301 ab/dès/from FFH 2351	499.453 M.D / M.C	599.416 599.416/599.415
10	Scherenlager Charnière supérieure du ciseaux Scissor hinge part	SL.K.3-6.130		499.455 E	599.443
12	Unterlage Ecklager (nicht notwendig) Cale charnière d'angle (pas nécessaire) Support for corner pivot (not necessary)				599.533
19	Falzschere Compas d'arrêt Rebate stay	FSR SL	FFH < 1300 mm FFH > 1300 mm	499.462 F.D	557.219 599.405
20	Kippband Paumelle soufflet Tilt hinge	KB.K.18-9		499.458 K.A	599.454
50	Stulpplatte Plaque Connecting piece	ER J SL			599.425
52	Anschlagplatte Plaque butée Stop plate	AWDR SL			599.400
56	Sicherheitsschliesblech Gâche de sécurité Security strike plate	SBS.S.9-18.J.LS	links/à gauche/left	499.459 S.A	599.482
60	Schraube / Vis / Screw M4x20				557.045
61	Schraube / Vis / Screw M4x12				557.046
62	Schraube / Vis / Screw M4x27				557.048
63	Beschlagsunterlage / Cale / Mechanism support				557.050

Ausgeführte Objekte
Objets réalisés
Completed projects

Jansen-Economy 50 Fenster
Jansen-Economy 50 fenêtres
Jansen-Economy 50 windows

De La Warr Pavilion, Bexhill-on-Sea/GB (Architekt: John McAslan & Partners, London/GB)



Verdeckt liegender Fensterbeschlag

- Einhandbeschlag für Dreh-, Drehkipp- und Stulpfenster
- Völlig verdeckt, im Falzbereich liegende Scheren-, Dreh- und Ecklagerungen
- Fensterbeschlag mit Pilzkopfverriegelung für erhöhte Einbruch-Sicherheit
- Anpressdruck verstellbar
- Flügel seitlich und in der Höhe regulierbar
- Keine Ausnehmungen für Bandteile und Dichtungen erforderlich
- Rationeller Einbau dank praktischer Verarbeitungs-Hilfsmitteln
- optional Mehrfachspaltlüftung
- optional Zuschlagsicherung
- Korrosionsbeständigkeit nach EN ISO 9227-NS Klasse 4 nach EN 1670

Ferrure de fenêtre non apparente

- Ferrure une main pour fenêtres à la française, oscillo-battantes et pour fenêtres à deux vantaux
- Pivots compas, compas et charnières d'angle non apparents dans la zone de la feuillure
- Ferrure de fenêtre avec verrouillage champignon pour une meilleure sécurité anti-effraction
- Pression d'appui réglable
- Vantaux réglables sur le côté et en hauteur
- Aucun fraisage nécessaire pour les pièces des paumelles et les joints
- Montage rationnel grâce aux outils d'usinage pratiques
- en option limiteur d'aération multiple
- en option sécurité fermeture brusque
- Résistance à la corrosion selon EN ISO 9227-NS classe 4 selon EN 1670

Concealed window fitting

- Single-handed fitting for tilt, turn/tilt and double leaf window
- Fully concealed, the scissor stay and side-hung and corner hinges are rebate-mounted
- Window fitting with mushroom closure for enhanced anti-burglar security
- Contact pressure adjustable
- Leaf can be regulated on the side and vertically
- No recesses required for hinge parts and weatherstrips
- Efficient installation thanks to practical assembly tools
- Optional multi-point ventilation
- Optional anti-slam fitting
- Corrosion resistance in accordance with EN ISO 9227-NS Class 4 in accordance with EN 1670



Folgende technische Rahmenbedingungen müssen beachtet werden:

Allgemein:

Max. Gewicht:	bis 180 kg
Max. Fläche:	3.0 m ²
Max. Seitenverhältnis FFB/FFH:	≤ 2:1
Max. Öffnungswinkel:	92°
G-Mass min.:	288 mm

Les conditions cadres techniques suivantes doivent être observées:

Généralités:

Poids max.:	jusqu'à 180 kg
Surface max.:	3.0 m ²
Rapport latéral max. largeur/hauteur FFB/FFH:	≤ 2:1
Angle d'ouverture max.:	92°
Mesure G min.:	288 mm

The following technical limiting conditions must be duly considered:

General:

Max. weight:	to 180 kg
Max. surface:	3.0 m ²
Max. ratio width/height FFB/FFH:	≤ 2:1
Max. opening angle:	92°
G-measurement min.:	288 mm

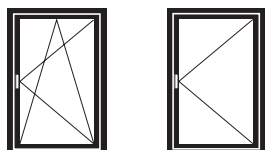

Flügelgrößen Drehkipp- und Drehfenster:

Max.	FFH = 2300 mm FFB = 1475 mm
Min.	FFH = 575 mm FFB = 480 mm

Grandeurs du vantail fenêtre oscillo-battante et à la française:

Max.	FFH = 2300 mm FFB = 1475 mm
Min.	FFH = 575 mm FFB = 480 mm

Size of leafs turn/tilt and side-hung windows:

Max.	FFH = 2300 mm FFB = 1475 mm
Min.	FFH = 575 mm FFB = 480 mm

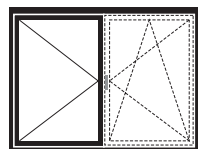

Flügelgröße Stulp-Fenster:

Max.	FFH = 2300 mm FFB = 1475 mm
Stulpflügel-Getriebe:	
Min.	FFH = 575 mm FFB = 480 mm

Grandeur du vantail fenêtre à deux vantaux:

Max.	FFH = 2300 mm FFB = 1475 mm
Min.	Mécanisme de vantail semi-fixe: FFH = 575 mm FFB = 480 mm

Size of leaf double-leaf window:

Max.	FFH = 2300 mm FFB = 1475 mm
Double-leaf operating mechanism:	
Min.	FFH = 575 mm FFB = 480 mm

Bei FFB/FFH ≤ 500 mm Flügelrahmen um 1 mm im Minus zuschneiden!

Si FFB/FFH ≤ 500 mm, le cadre de vantail doit être coupé d'un millimètre de moins que la longueur théorique!

If FFB/FFH ≤ 500 mm, cut the leaf frame to 1 mm less than the nominal length!

Sondergeometrien siehe Seite 94

Géométrie spéciale voir page 94

Special geometry see page 94

Max. Gewicht für Dreh- und Drehkipp-Fenster in Abhängigkeit Verhältnis Flügelfalzbreite (FFB) / Flügelfalzhöhe (FFH)

Poids maximal pour les fenêtres à la française et oscillo-battantes en fonction du rapport largeur de feuillure du vantail (FFB) / hauteur de feuillure du vantail (FFH)

Max. weight for side-hung and turn/tilt windows dependent on the relationship between leaf rebate width (FFB) / leaf rebate height (FFH)

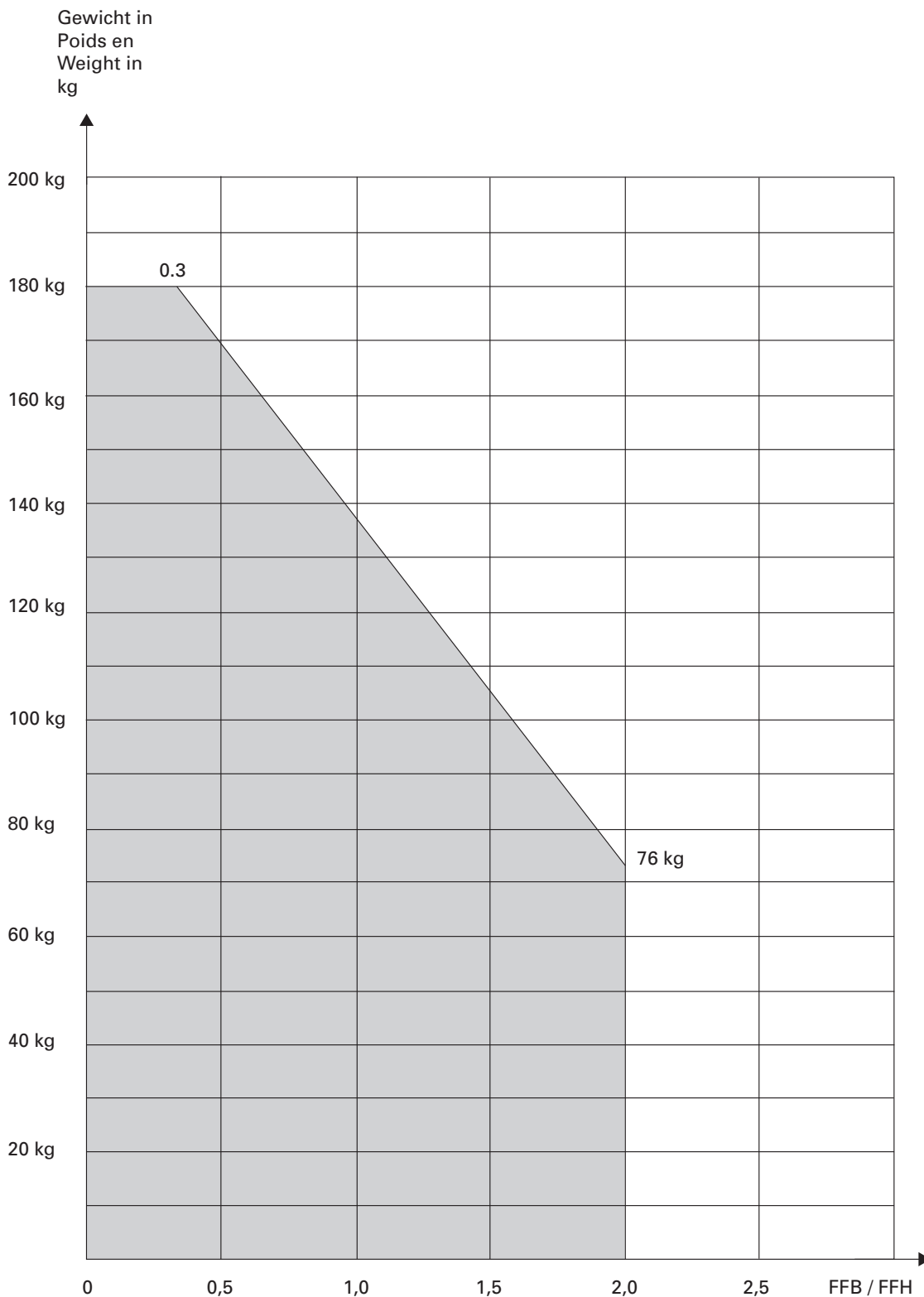

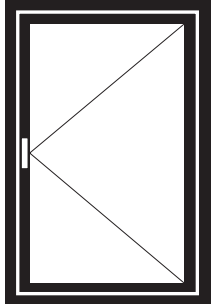
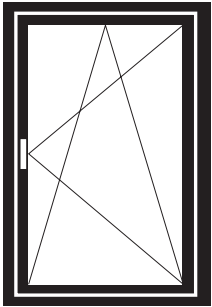

Verdeckt liegender Drehkipp- und Drehbeschlag

Ferrure oscillo-battante et à la française non apparente

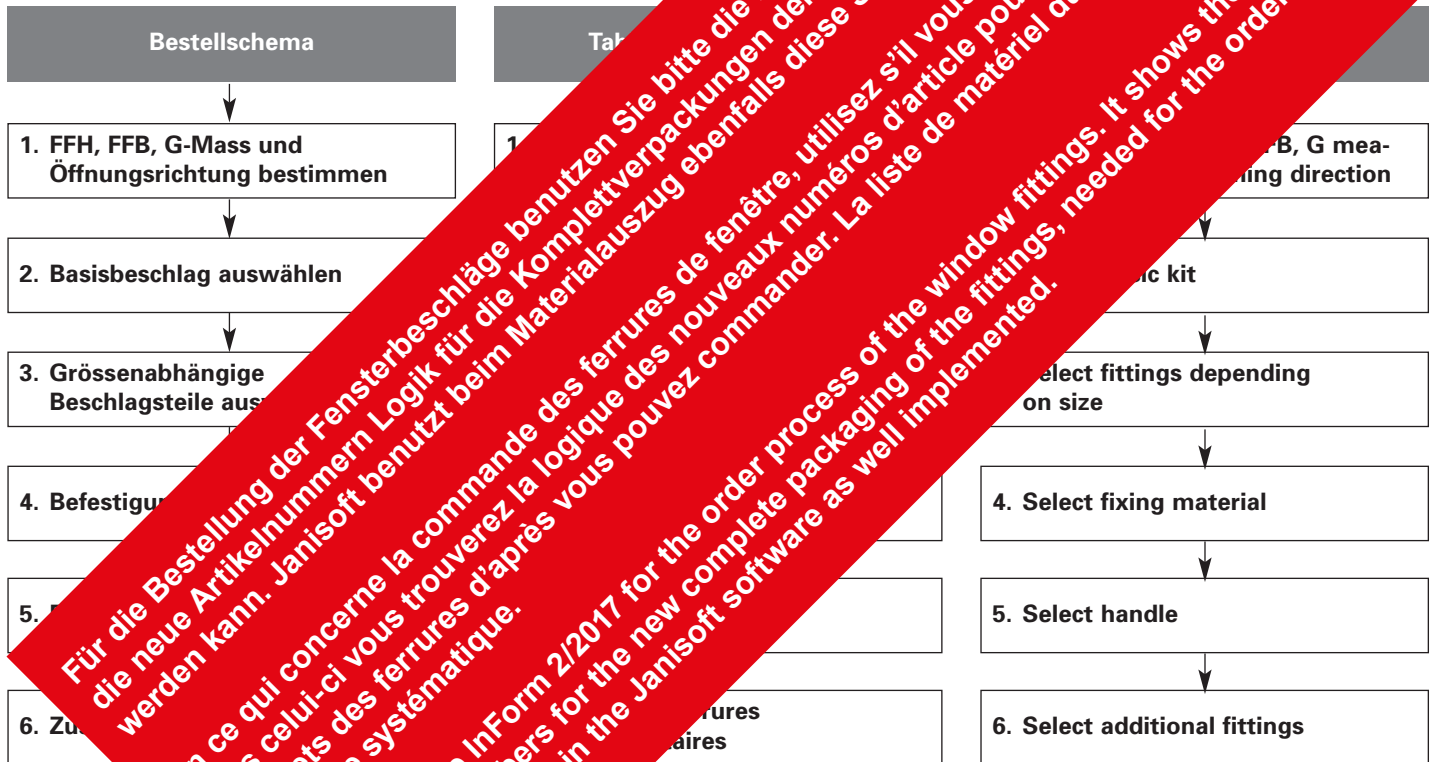

Zusätzlich bestellen:
 - Beim Drehflügel zusätzlich Drehkippbeschlag Anschlag 599.400 bestellen

Commander séparément:
 - Commander une plaque-butée 599.400 en plus de la ferrure oscillo-battante pour l'ouvrant à la française

Order separately:
 - For side-hung vents, order stop plate 599.400 in addition to the turn/tilt fitting

Für die Bestellung der Fensterbeschläge benutzen Sie bitte die InForm 2/2017. In dieser finden Sie die neue Artikelnummern Logik für die Komplettverpackungen der Beschläge nach der bestellt werden kann. Janisoft benutzt beim Materialauszug ebenfalls diese Systematik.
 En ce qui concerne la commande des ferrures de fenêtre, utilisez s'il vous plait l'InForm 2/2017. Dans celui-ci vous trouverez la logique des nouveaux numéros d'article pour les emballages complets des ferrures d'après vous pouvez commander. La liste de matériel du Janisoft utilise déjà cette systématique.
 Please use the InForm 2/2017 for the order process of the window fittings. It shows the logic of the item numbers for the new complete packaging of the fittings, needed for the order. The new system is in the Janisoft software as well implemented.

1. FFH, FFH, G-Mass und Öffnungsrichtung bestimmen

1. Choisir FFH, FFH, la mesure G et l'orientation de l'ouverture

1. Determine the vent rebate height (FFH), vent rebate width (FFB), G measurement and opening direction

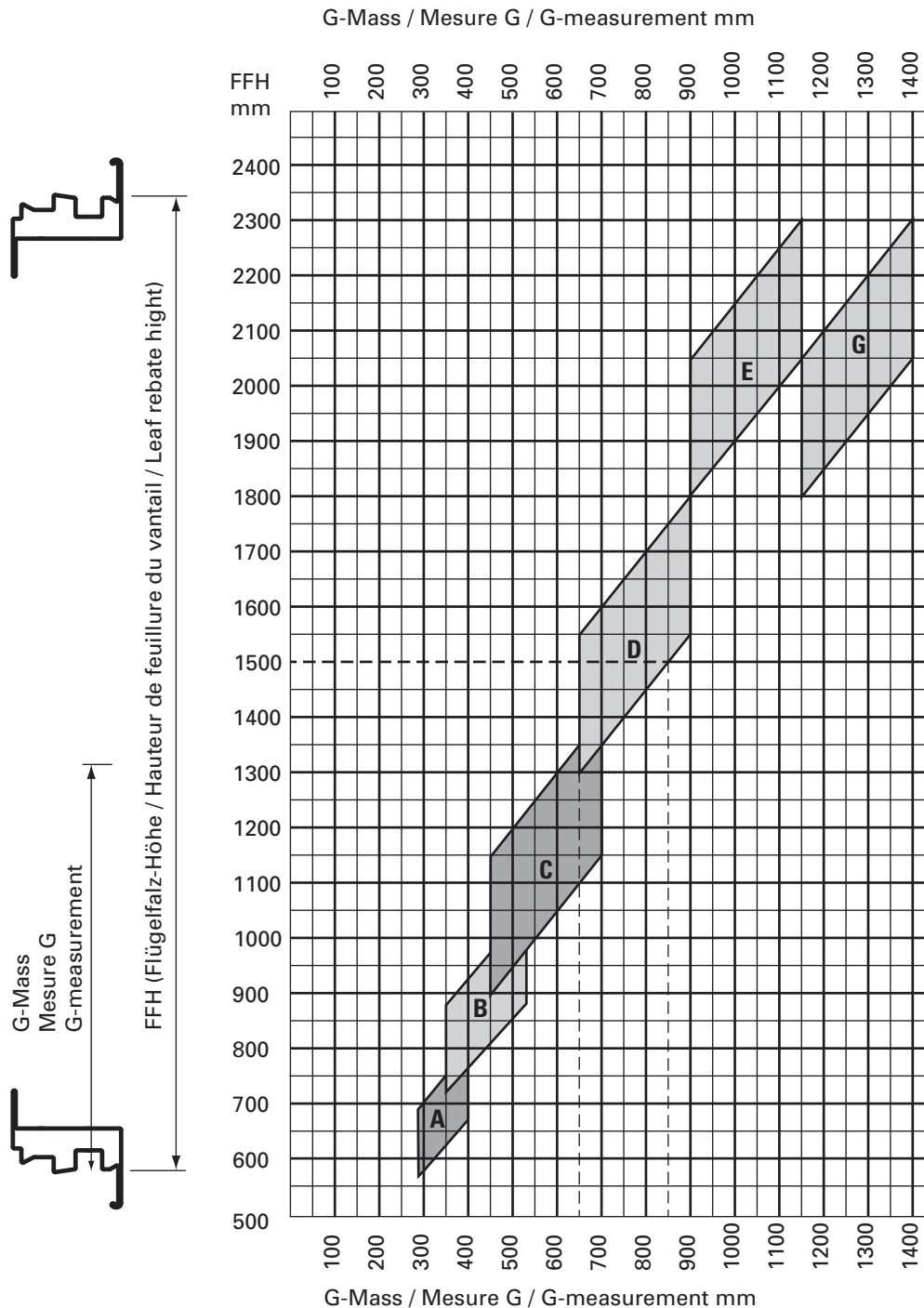

Beispiel:
 FFH 1500 mm
 G-Mass
 von 650 mm bis 850 mm

Example:
 FFH 1500 mm
 Mesure G de 650 mm à
 850 mm

Example:
 FFH 1500 mm
 G measurement from
 650 mm to 850 mm

- A Einbau Fehlschalt-sicherung nicht möglich
- A Montage anti-fausse manoeuvre pas possible
- A Installation fool-proof mechanism not possible

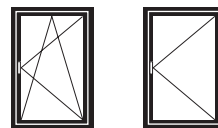
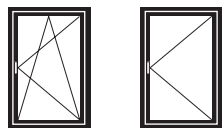
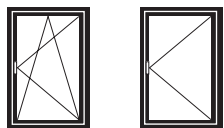

2. Basisbeschlag auswählen

2. Choisir paquet de base

2. Select basic kit

558.010

Basisbeschlag
Verdeckt liegender Drehkipp-Beschlag,
DIN links

VE = 1 Garnitur bestehend aus:

2 Eckumlenkung E1	599.402
1 Kippschliessblech SBK.S.9-18.J	599.484
2 Sicherheits-Schliessblech links SBS.S.9-18.J.LS	599.482
3 Stulpplatten ER J SL	599.425
1 Fehlschaltsicherung FSA	599.406
1 Ecklager links EL.SJ.SE.20-9.Z.LS	599.461
1 Eckumlenkung E1.SE	599.463
1 Flügellager FL.SE.1	599.464
1 Schere links S.SJ.SE.20-9.Z.LS	599.472
1 Auflauf	599.479
1 Mittenverriegelung MK.PA.250-1	599.417

558.010

Paquet de base
Ferrure oscillo-battant non apparente,
DIN à gauche

UV = 1 garniture comprenant:

2 Renvoi d'angle E1	599.402
1 Gâche oscillo-battant SBK.S.9-18.J	599.484
2 Gâches de sécurité à gauche SBS.S.9-18.J.LS	599.482
3 Plaques ER J SL	599.425
1 Anti-fausse manoeuvre FSA	599.406
1 Charnière inférieure d'angle à gauche EL.SJ.SE.20-9.Z.LS	599.461
1 Renvoi d'angle E1.SE	599.463
1 Fiche d'angle du vantail FL.SE.1	599.464
1 Compas à gauche S.SJ.SE.20-9.Z.LS	599.472
1 Appui	599.479
1 Verrouillage central MK.PA.250-1	599.417

558.010

Basic kit
Concealed turn/tilt fitting,
left-hand opening

PU = 1 set consisting of:

2 Corner guide E1	599.402
1 Tilt striking plate SBK.S.9-18.J	599.484
2 Security strike plate left SBS.S.9-18.J.LS	599.482
3 Connecting pieces ER J SL	599.425
1 Fool-proof mechanism FSA	599.406
1 Corner hinge part left EL.SJ.SE.20-9.Z.LS	599.461
1 Corner guide E1.SE	599.463
1 Leaf hinge part FL.SE.1	599.464
1 Stay left S.SJ.SE.20-9.Z.LS	599.472
1 Lock staple	599.479
1 Central lock MK.PA.250-1	599.417

Ansicht von innen (Bandseite)
Vue de l'intérieur (côté paumelle)
View from inside (hinge side)

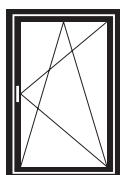

DIN links/gauche/left

DIN rechts/droite/right

558.011

Basisbeschlag **Verdeckt liegender Drehkipp-Beschlag,** **DIN rechts**

VE = 1 Garnitur bestehend aus:

2 Eckumlenkung E1	599.402
1 Kippschliessblech SBK.S.9-18.J	599.484
2 Sicherheits-Schliessblech rechts SBS.S.9-18.J.RS	599.483
3 Stulpplatten ER J SL	599.425
1 Fehlschaltsicherung FSA	599.406
1 Ecklager rechts EL.SJ.SE.20-9.Z.RLS	599.462
1 Eckumlenkung E1.SE	599.463
1 Flügellager FL.SE.1	599.464
1 Schere rechts S.SJ.SE.20-9.Z.RS	599.472
1 Auflauf	599.479
1 Mittenverriegelung MK.PA.250-1	599.417

558.011

Paquet de base **Ferrure oscillo-battante non apparente,** **DIN à droite**

UV = 1 garniture comprenant:

2 Renvoi d'angle E1	599.402
1 Gâche oscillo-battant SBK.S.9-18.J	599.484
2 Gâches de sécurité à droite SBS.S.9-18.J.RS	599.483
3 Plaques ER J SL	599.425
1 Anti-fausse manoeuvre FSA	599.406
1 Charnière inférieure d'angle à droite EL.SJ.SE.20-9.Z.RS	599.462
1 Renvoi d'angle E1.SE	599.463
1 Fiche d'angle du vantail FL.SE.1	599.464
1 Compas à droite S.SJ.SE.20-9.Z.RS	599.472
1 Appui	599.479
1 Verrouillage central MK.PA.250-1	599.417

558.011

Basic kit **Concealed turn/tilt fitting,** **right-hand opening**

PU = 1 set consisting of:

2 Corner guide E1	599.402
1 Tilt striking plate SBK.S.9-18.J	599.484
2 Security strike plate right SBS.S.9-18.J.RS	599.483
3 Connecting pieces ER J SL	599.425
1 Fool-proof mechanism FSA	599.406
1 Corner hinge part right EL.SJ.SE.20-9.Z.RS	599.462
1 Corner guide E1.SE	599.463
1 Leaf hinge part FL.SE.1	599.464
1 Stay right S.SJ.SE.20-9.Z.RS	599.472
1 Lock staple	599.479
1 Central lock MK.PA.250-1	599.417

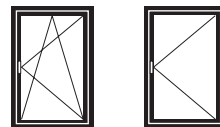
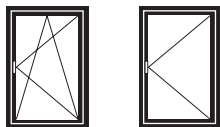
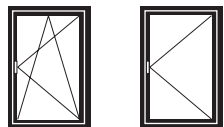

**3. Grössenabhängige
Beschlagteile auswählen**

**3. Choisir les ferrures en
fonction de la dimension**

**3. Select fittings
depending on size**

Breite

Largeur

Breite

FFB mm	Oberschiene Tringle supérieure Top rod	Drehbegrenzer Compas de limitation d'ouverture Opening limiter	Rahmenanbindung Raccordement au cadre Frame attachment	Mittenverriegelung Verrouillage central Central lock	Schliessblech Gâche Strike plate
480 - 550	1 x 599.466 OS.SE.550				
551 - 800	1 x 599.467 OS.SE.800	1 x 599.457 DB.SE.1	1 x 599.470*/471** RA.DB.SJ.SE.20-9.xx		
801 - 1025	1 x 599.468 OS.SE.1025-1	1 x 599.457 DB.SE.1	1 x 599.470*/471** RA.DB.SJ.SE.20-9.xx		1 x 599.482*/483** SBS.S.9-18.J.xx
1026 - 1250	1 x 599.469 OS.SE.1250-1	1 x 599.457 DB.SE.1	1 x 599.470*/471** RA.DB.SJ.SE.20-9.xx		1 x 599.482*/483** SBS.S.9-18.J.xx
1251 - 1475	1 x 599.469 OS.SE.1250-1	1 x 599.457 DB.SE.1	1 x 599.470*/471** RA.DB.SJ.SE.20-9.xx	1 x 599.412 MK.250-0 1 x 599.416 MK.750-1	2 x 599.482*/483** SBS.S.9-18.J.xx

Höhe Getriebeseite

Hauteur côté crémonne

Height mechanism side

FFH mm		Getriebe Crémone Mechanism	G-Mass Mesure G G-measurement mm	Mittenverriegelung unten Verrouillage central inférieur Central lock bottom	Schliessblech Gâche Strike plate
575 - 800	A	1 x 599.407 GAM.800.D7,5	288 - 400		
711 - 1050	B	1 x 599.408 GAM.1050-1.D7,5	355 - 525		1 x 599.482*/483** SBS.S.9-18.J.xx
901 - 1400	C	1 x 599.409 GAM.1400-1.D7,5	450 - 700		1 x 599.482*/483** SBS.S.9-18.J.xx
1301 - 1800	D	1 x 599.410 GAM.1800-2.D7,5	650 - 900		2 x 599.482*/483** SBS.S.9-18.J.xx
1801 - 2300	E	1 x 599.411 GAM.2300-3.D7,5	900 - 1150		3 x 599.482*/483** SBS.S.9-18.J.xx
1801 - 2300	G	1 x 599.410 GAM.1800-2.D7,5	1150 - 1400	1 x 599.414 MK.500-0	2 x 599.482*/483** SBS.S.9-18.J.xx

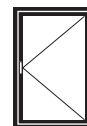
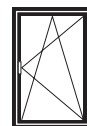

Höhe Bandseite

Hauteur côté paumelle

Height hinge side

FFH mm	Mittenverriegelung Verrouillage central Central lock	Schliessblech Gâche Strike plate	Flügelgewicht > 100 kg Poids de vantail > 100 kg Leaf weight > 100 kg
1101 - 1400	1 x 599.413 MK.250-1	1 x 599.482*/483** SBS.S.9-18.J.xx	1 x 599.455*/456** AP.SJ.SE.20-9.xx 1 x 599.465 FLS.SE
1401 - 2095	1 x 599.415 MK.500-1	1 x 599.482*/483** SBS.S.9-18.J.xx	1 x 599.455*/456** AP.SJ.SE.20-9.xx 1 x 599.465 FLS.SE
2096 - 2300	1 x 599.415 MK.500-1 1 x 599.416 MK.750-1	2 x 599.482*/483** SBS.S.9-18.J.xx	1 x 599.455*/456** AP.SJ.SE.20-9.xx 1 x 599.465 FLS.SE

* links / ** rechts

* à gauche / ** à droite

* left / ** right

4. Befestigungsmaterial auswählen

4. Choisir le matériel de fixation

4. Select fixing material

Schraubenbedarf

Ungefähre Anzahl Schrauben
pro Flügel:

557.045 ca. 60 Schrauben
557.046 ca. 10 Schrauben

Besoins en vis

Nombre approximatif de vis par
vantail:

557.045 env. 60 vis
557.046 env. 10 vis

Screws required

Approximate number of screws
per vent:

557.045 approx. 60 screws
557.046 approx. 10 screws

Beschlagsunterlagen

557.050 ca. 20 Stück

Cale

557.050 env. 20 pièces

Mechanism support

557.050 approx. 20 pieces

5. Fenstergriffe auswählen

siehe Seite 40

5. Choisir la poignée

voir page 40

5. Select handle

see page 40

6. Zusätzliche Beschläge auswählen

siehe Seite 42

6. Choisir des ferrures supplémentaires

voir page 42

6. Select additional fittings

see page 42

**Legende verdeckt liegender
 Dreh- und Drehkippbeschlag**

**Légende ferrure oscillo-battante et
 à la française non apparente**

**Key to concealed turn/tilt and
 side-hung fitting**

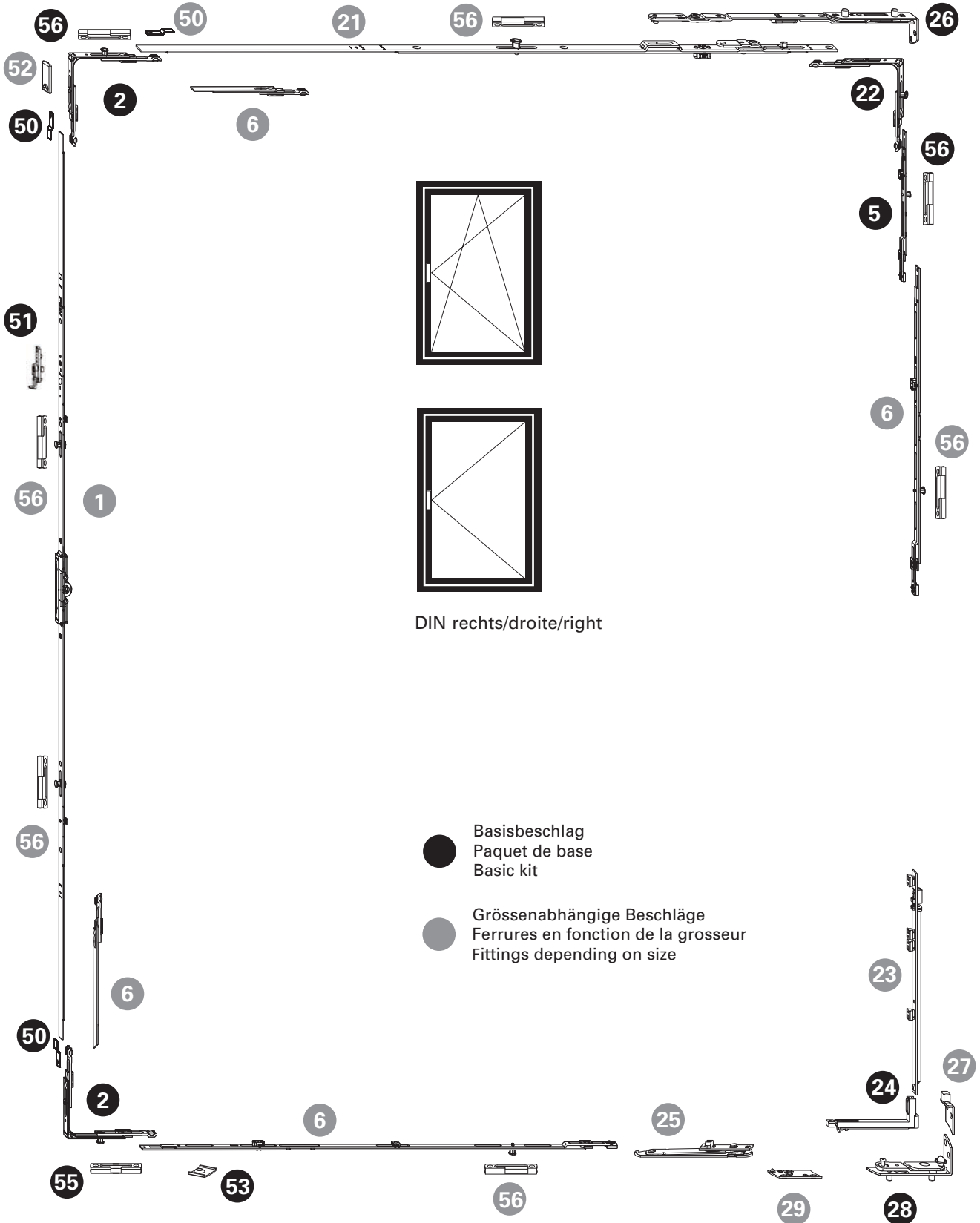

Verdeckt liegender Drehkipp- und Drehbeschlag
Ferrure oscillo-battante et à la française non apparente
Concealed turn/tilt and side-hung fitting

Jansen-Economy 50 Fenster
 Jansen-Economy 50 fenêtres
 Jansen-Economy 50 windows

Pos.	Beschrieb Description Description	Kennzeichnung Désignation Designation	Einsatz Utilisable Suitable	Bohrlehre Gabarit de perçage Drilling jig	Artikel-Nr No d'article Part no.
1	Getriebechiene Crémone de tringle Mechanism rod	GAM.800.D.7,5 GAM.1050-1.D.7,5 GAM.1400-1.D.7,5 GAM.1800-2.D.7,5 GAM.2300-3.D.7,5	FFH 575 - 800 FFH 711 - 1050 FFH 901 - 1400 FFH 1301 - 2300 FFH 1801 - 2300	499.451 G.A G.B G.C G.D G.E	599.407 599.408 599.409 599.410 599.411
2	Eckmülnkung Renvoi d'angle Corner guide	E1		499.456 E	599.402
5	Mittenverriegelung Verrouillage central Central lock	MK.PA.250-1		499.453 M.B	599.417
6	Mittenverriegelung Verrouillage central Central lock	MK.750-1/MK.250-0 MK.250-1 MK.500-1 MK.750-1 MK.500-0	ab/dès/from FFB 1251 ab/dès/from FFB 1101 ab/dès/from FFB 1401 ab/dès/from FFB 2096 ab/dès/from FFB 1800	499.453 M.D/M.A M.A M.C M.D M.C	599.416/412 599.413 599.415 599.416 599.414
21	Oberschiene Tringle supérieure Top rod	O.S.SE.550 O.S.SE.800 O.S.SE.1025-1 O.S.SE.1250-1	FFB 480 - 550 FFB 551 - 800 FFB 801 - 1025 FFB 1026 - 1475	499.454 O.F O.G O.H O.I	599.466 599.467 599.468 599.469
22	Eckmülnkung Renvoi d'angle Corner guide	E1.SE		499.456 E	599.463
23	Flügelaggerschiene Crémone fiche d'angle du vantail Leaf hinge part rod	FLS.SE	ab/dès/from 100 kg	499.463 F.B	599.465
24	Flügelager Fiche d'angle du vantail Leaf hinge part	FL.SE.1		499.463 F.A	599.464
25	Drehbegrenzer Compas de limitation d'ouverture Opening limiter	DB.SE.1	ab/dès/from FFB 551	499.463 D.C	599.457
26	Schere Compas Stay	S.S.J.SE.20-9.Z.LS S.S.J.SE.20-9.Z.RS	links/à gauche/left rechts/à droite/right	499.461 S/D.A	599.472 599.473
27	Adapterplatte Plaque d'adaptation Adapter plate	AP.S.J.SE.20-9.LS AP.S.J.SE.20-9.RS	ab/dès/from 100 kg links/à gauche/left rechts/à droite/right	499.460 A.C	599.455 599.456
28	Ecklager Charnière inférieure d'angle Corner hinge part	EL.S.J.SE.20-9.Z.LS EL.S.J.SE.20-9.Z.RS	links/à gauche/left rechts/à droite/right	499.460 E.A	599.461 599.462
29	Rahmenanbindung Raccordement au cadre Frame attachment	RA.DB.SE.20-9.LS RA.DB.SE.20-9.RS	ab/dès/from FFB 551	499.460 R.B	599.470 599.471
50	Stulpplatte Plaque Connecting piece	ER J SL			599.425
51	Fehlschaltssicherung Anti-fausse manoeuvre Fool-proof mechanism	FSA			599.406
52	Anschlagplatte/Plaque-butée/Stop plate AWDR				599.400
53	Auflauf / Appui / Lock staple				599.479
55	Kippschliessblech Gâche oscillo-battante Tilt striking plate	SBK.S.9-18.J		499.459 S.A	599.484
56	Sicherheitsschliessblech Gâche de sécurité Security strike plate	SBS.S.9-18.J.LS SBS.S.9-18.J.RS	links/à gauche/left rechts/à droite/right	499.459 S.A	599.482 599.483
60	Schraube / Vis / Screw M4x20				557.045
61	Schraube / Vis / Screw M4x12				557.046
63	Beschlagsunterlage / Cale / Mechanism support				557.050

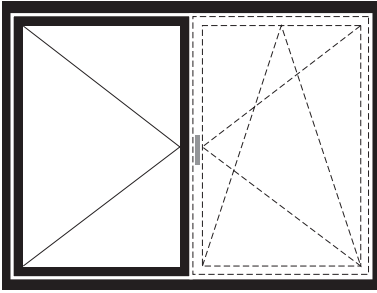

**Stulp-Beschlag
(Standflügel)**

**Ferrure pour fenêtre
à deux vantaux
(Vantail semi-fixe)**



Für die Bestellung der Fensterbeschläge benutzen Sie bitte die InForm 2/2017. In dieser finden Sie die neue Artikelnummern Logik für die Komplettverpackungen der Beschläge nach der bestellt werden kann. Janisoft benutzt beim Materialauszug ebenfalls diese Systematik.

En ce qui concerne la commande des ferrures de fenêtre, utilisez s'il vous plait l'InForm 2/2017. Dans celui-ci vous trouverez la logique des nouveaux numéros d'article pour les emballages complets des ferrures d'après vous pouvez commander. La liste de matériel du Janisoft utilise déjà cette systématique.

Please use the InForm 2/2017 for the order process of the window fittings. It shows the logic of the item numbers for the new complete packaging of the fittings, needed for the order. The new system is in the Janisoft software as well implemented.

Verdeckt liegender Stulp-Beschlag (Standflügel)**Ferrure pour fenêtre à deux vantaux non apparente (vantail semi-fixe)****Concealed fitting for double leaf window (secondary leaf)**

Jansen-Economy 50 Fenster

Jansen-Economy 50 fenêtres

Jansen-Economy 50 windows

**1. FFH, FFB, G-Mass,
Stulpgetriebe und
Öffnungsrichtung bestimmen**

Das Stulpgetriebe wird in Abhängigkeit der Getriebeschiene des erstöffnenden Flügels ausgewählt. Hierbei kommt folgende Tabelle zum Einsatz:

**1. Choisir FFH, FFB, la
mesure G, crémone de
vantail semi-fixe et
l'orientation de l'ouverture**

La tige de crémone de vantail semi-fixe est sélectionnée en fonction de la crémone de tringle du vantail ouvrant en premier. Utiliser le tableau suivant:

**1. Determine the vent rebate
height (FFH), vent rebate
width (FFB), double-vent
gearbox, G measurement
and opening direction**

The track for double-leaf windows is to be selected per the operating rod of the wing which opens first. The following table is used for this:

Getriebeschiene Öffnungsflügel Crémone de tringle vantail principal Mechanism rod opening leaf	definiert Stulpgetriebe défini la crémone de vantail semi-fixe defined double-vent gearbox
599.407 GAM.800-D7,5	Balkontürschnäpper 599.401 / Schnäpperbolzen 599.419 Loqueteau pour porte de balcon 599.401 / goujon d'encliquetage 599.419 Balcony door catch 599.401 / Bolt for spring-loaded catch 599.419
599.408 GAM.1050-1.D7,5	599.421 GASM.1050-1.E3
599.409 GAM.1400-1.D7,5	599.422 GASM.1400-1
599.410 GAM.1800-2.D7,5	599.423 GASM.1800-2
599.411 GAM.2300-3.D7,5	599.424 GASM.2300-3

Verdeckt liegender Stulp-Beschlag (Standflügel)

Ferrure pour fenêtre à deux vantaux non apparente (vantaill semi-fixe)

Concealed fitting for double leaf window (secondary leaf)

Jansen-Economy 50 Fenster

Jansen-Economy 50 fenêtres

Jansen-Economy 50 windows

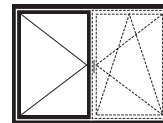
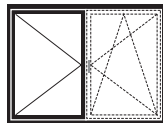
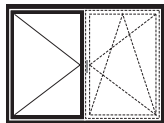

2. Basisbeschlag auswählen

2. Choisir paquet de base

2. Select basic kit

558.012

Basisbeschlag
Verdeckt liegender Stulp-Beschlag
(Standflügel),
DIN links

VE = 1 Garnitur bestehend aus:

2 Eckumlenkung E1	599.402
1 Kippschliessblech SBK.S.9-18.J	599.484
1 Sicherheits-Schliessblech links SBS.S.9-18.J.LS	599.482
2 Stulpplatten ER J SL	599.425
1 Drehlager links DL.SJ.SE.20-9.Z.LS	599.458
1 Drehlagerschiene DLS.K.SE.9-13	599.460
1 Ecklager links EL.SJ.SE.20-9.Z.LS	599.461
1 Flügellager FL.SE.1	599.464
1 Auflauf	599.479

558.012

Paquet de base
Ferrure pour fenêtre à deux vantaux
non apparente (vantaill semi-fixe),
DIN gauche

UV = 1 garniture comprenant:

2 Renvoi d'angle E1	599.402
1 Gâche oscillo-battant SBK.S.9-18.J	599.484
1 Gâches de sécurité à gauche SBS.S.9-18.J.LS	599.482
2 Plaques ER J SL	599.425
1 Compas à gauche DL.SJ.SE.20-9.Z.LS	599.458
1 Crémone de compas DLS.K.SE.9-13	599.460
1 Charnière inférieure d'angle à gauche EL.SJ.SE.20-9.Z.LS	599.461
1 Fiche d'angle du vantaill FL.SE.1	599.464
1 Appui	599.479

558.012

Basic kit
Concealed fitting for double leaf
window (secondary leaf),
left-hand opening

PU = 1 set consisting of:

2 Corner guide E1	599.402
1 Tilt striking plate SBK.S.9-18.J	599.484
1 Security strike plate left SBS.S.9-18.J.LS	599.482
2 Connecting pieces ER J SL	599.425
1 Pivot hinge left DL.SJ.SE.20-9.Z.LS	599.458
1 Pivot hinge rod DLS.K.SE.9-13	599.460
1 Corner hinge part left EL.SJ.SE.20-9.Z.LS	599.461
1 Leaf hinge part FL.SE.1	599.464
1 Lock staple	599.479

Ansicht von innen (Bandseite)

Vue de l'intérieur (côté paumelle)

View from inside (hinge side)

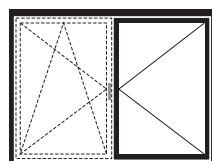
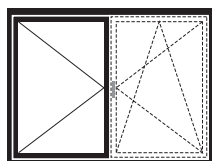

DIN links/gauche/left

DIN rechts/droite/right

Verdeckt liegender Stulp-Beschlag (Standflügel)**Ferrure pour fenêtre à deux vantaux non apparente (vantail semi-fixe)****Concealed fitting for double leaf window (secondary leaf)**

Jansen-Economy 50 Fenster

Jansen-Economy 50 fenêtres

Jansen-Economy 50 windows

558.013**Basisbeschlag****Verdeckt liegender Stulp-Beschlag
(Standflügel),
DIN rechts**

VE = 1 Garnitur bestehend aus:

2 Eckumlenkung E1	599.402
1 Kippschliessblech SBK.S.9-18.J	599.484
1 Sicherheits-Schliessblech rechts SBS.S.9-18.J.RS	599.483
2 Stulpplatten ER J SL	599.425
1 Drehlager rechts DL.SJ.SE.20-9.Z.RS	599.459
1 Drehlagerschiene DLS.K.SE.9-13	599.460
1 Ecklager rechts EL.SJ.SE.20-9.Z.RS	599.462
1 Flügellager FL.SE.1	599.464
1 Auflauf	599.479

558.013**Paquet de base****Ferrure pour fenêtre à deux vantaux
non apparente (vantail semi-fixe),
DIN droite**

UV = 1 garniture comprenant:

2 Renvoi d'angle E1	599.402
1 Gâche oscillo-battant SBK.S.9-18.J	599.484
1 Gâches de sécurité à droite SBS.S.9-18.J.RS	599.483
2 Plaques ER J SL	599.425
1 Compas à droite DL.SJ.SE.20-9.Z.RS	599.459
1 Crémone de compas DLS.K.SE.9-13	599.460
1 Charnière inférieure d'angle à droite EL.SJ.SE.20-9.Z.RS	599.462
1 Fiche d'angle du vantail FL.SE.1	599.464
1 Appui	599.479

558.013**Basic kit****Concealed fitting for double leaf
window (secondary leaf),
right-hand opening**

PU = 1 set consisting of:

2 Corner guide E1	599.402
1 Tilt striking plate SBK.S.9-18.J	599.484
1 Security strike plate right SBS.S.9-18.J.RS	599.483
2 Connecting pieces ER J SL	599.425
1 Pivot hinge right DL.SJ.SE.20-9.Z.RS	599.459
1 Pivot hinge rod DLS.K.SE.9-13	599.460
1 Corner hinge part right EL.SJ.SE.20-9.Z.RS	599.462
1 Leaf hinge part FL.SE.1	599.464
1 Lock staple	599.479

Verdeckt liegender Stulp-Beschlag (Standflügel)
Ferrure pour fenêtre à deux vantaux non apparente (vantaïl semi-fixe)
Concealed fitting for double leaf window (secondary leaf)

Jansen-Economy 50 Fenster
 Jansen-Economy 50 fenêtres
 Jansen-Economy 50 windows

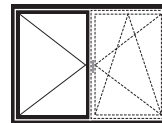
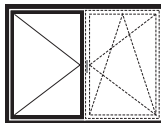
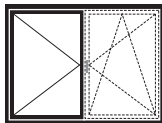

3. Grössenabhängige Beschlagteile auswählen

3. Choisir les ferrures en fonction de la dimension

3. Select fittings depending on size

Höhe

Hauteur

Height

FFH mm	Stulpgetriebe Crémone de vantaïl semi-fixe Double-vent gearbox	G-Mass Drehkipplügel Mesure G vantaïl oscillo battant G-measurement turn/tilt window mm	Mittenverriegelung unten Verrouillage central inférieur Central lock bottom	Zwangsverriegelung Verrouillage forcé Security locking system	Flügelgewicht Poids de vantaïl Leaf weight > 100 kg
575 - 880	1 x 599.401 BK SL 1 x 599.419 BK-FC SL	288 - 440			
881 - 1050	1 x 599.421 GASM.1050-1.E3	440 - 525			
901 - 1400	1 x 599.422 GASM.1400-1	450 - 700		1 x 599.474 SZV SL 1 x 599.475 ZV SL	1 x 599.455* AP.SJ.SE.20-9.LS 1 x 599.456** AP.SJ.SE.20-9.RS 1 x 599.465 FLS.SE
1301 - 1800	1 x 599.423 GASM.1800-2	650 - 900		1 x 599.474 SZV SL 1 x 599.475 ZV SL	1 x 599.455* AP.SJ.SE.20-9.LS 1 x 599.456** AP.SJ.SE.20-9.RS 1 x 599.465 FLS.SE
1801 - 2300	1 x 599.424 GASM.2300-3	900 - 1150		2 x 599.474 SZV SL 2 x 599.475 ZV SL	1 x 599.455* AP.SJ.SE.20-9.LS 1 x 599.456** AP.SJ.SE.20-9.RS 1 x 599.465 FLS.SE
1801 - 2300	1 x 599.423 GASM.1800-2	1150 - 1400	1 x 599.414 MK.500-0	2 x 599.474 SZV SL 2 x 599.475 ZV SL	1 x 599.455* AP.SJ.SE.20-9.LS 1 x 599.456** AP.SJ.SE.20-9.RS 1 x 599.465 FLS.SE

* links / ** rechts

* à gauche / ** à droite

* left / ** right

Verdeckt liegender Stulp-Beschlag (Standflügel)**Ferrure pour fenêtre à deux vantaux non apparente (vantaïl semi-fixe)****Concealed fitting for double leaf window (secondary leaf)**

Jansen-Economy 50 Fenster

Jansen-Economy 50 fenêtres

Jansen-Economy 50 windows

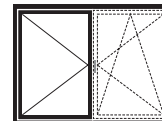
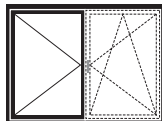
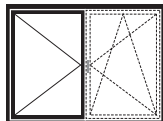
**Breite****Largeur****Width**

FFB mm	Drehbegrenzer Compas de limitation d'ouverture Opening limiter	Rahmenanbindung Raccordement au cadre Frame attachment	Mittenverriegelung Verrouillage central Central lock	Schliessblech Gâche Strike plate
480 - 550				
551 - 1250	599.457 DB.SE.1	599.470*/471** RA.DB.SJ.20-9.xx		
1251 - 1475	599.457 DB.SE.1	599.470*/471** RA.DB.SJ.20-9.xx	2 x 599.416 MK.750-1	2 x 599.482*/483** SBS.S.9-18.J.xx

**4. Befestigungsmaterial
auswählen****Schraubenbedarf**Ungefähre Anzahl Schrauben
pro Flügel:**557.045** ca. 60 Schrauben**557.046** ca. 10 Schrauben**Beschlagsunterlagen****557.050** ca. 20 Stück**4. Choisir le matériel de
fixation****Besoins en vis**Nombre approximatif de vis par
vantaïl:**557.045** env. 60 vis**557.046** env. 10 vis**Cale****557.050** env. 20 pièces**4. Select fixing material****Screws required**Approximate number of screws
per vent:**557.045** approx. 60 screws**557.046** approx. 10 screws**Mechanism support****557.050** approx. 20 pieces**5. Zusätzliche Beschläge
auswählen**

siehe Seite 42

**5. Choisir des ferrures
supplémentaires**

voir page 42

5. Select additional fittings

see page 42

Verdeckt liegender Stulp-Beschlag (Standflügel)

Ferrure pour fenêtre à deux vantaux non apparente (vantail semi-fixe)

Concealed fitting for double leaf window (secondary leaf)

Jansen-Economy 50 Fenster

Jansen-Economy 50 fenêtres

Jansen-Economy 50 windows

Legende verdeckt liegender Stulpbeschlag

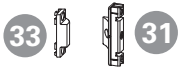
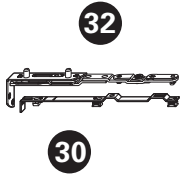

Légende ferrure pour fenêtre à deux vantaux non apparente

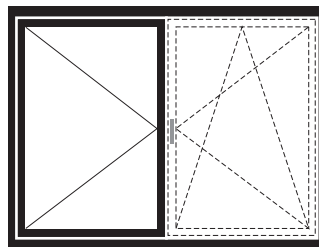
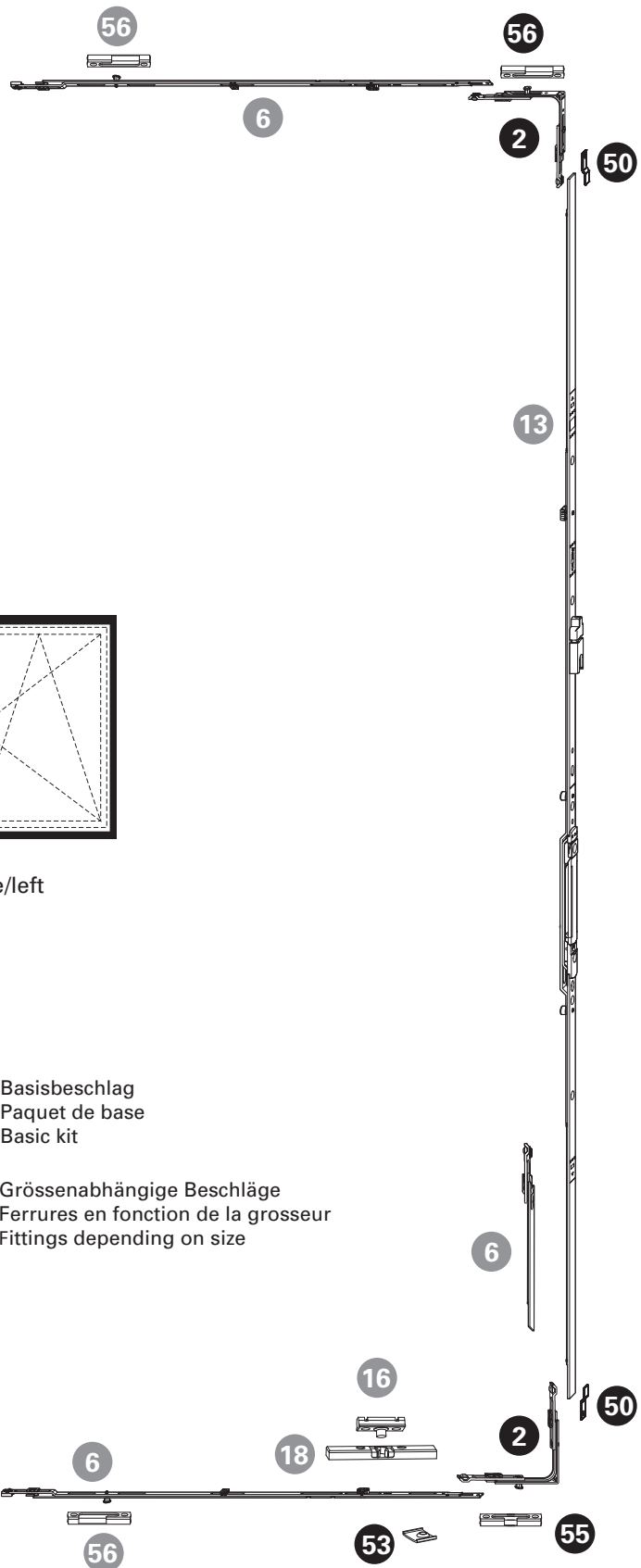

DIN links/gauche/left

- Basisbeschlag
Paquet de base
Basic kit
- Größenabhängige Beschläge
Ferrures en fonction de la grosseur
Fittings depending on size

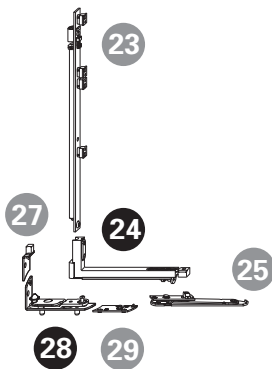

Verdeckt liegender Stulp-Beschlag (Standflügel)
Ferrure pour fenêtre à deux vantaux non apparente (vantail semi-fixe)
Concealed fitting for double leaf window (secondary leaf)

Jansen-Economy 50 Fenster
 Jansen-Economy 50 fenêtres
 Jansen-Economy 50 windows

Pos.	Beschrieb Description Description	Kennzeichnung Désignation Designation	Einsatz Utilisable Suitable	Bohrlehre Gabarit de perçage Drilling jig	Artikel-Nr No d'article Part no.
2	Eckumlenkung Renvoi d'angle Corner guide	E1		499.456 E	599.402
6	Mittenverriegelung Verrouillage central Central lock	MK.750-1 MK.500-0	ab/dès/from FFB 1251 ab/dès/from FFH 1800	499.453 M.D M.C	599.416 599.414
13	Stulpgetriebe Crémone de vantail semi-fixe Double-vent gearbox	GASM.1050-1.E3 GASM.1400-1 GASM.1800-2 GASM.2300-3	FFH 881 - 1050 FFH 901 - 1400 FFH 1301 - 2300 FFH 1801 - 2300	499.452 S.B S.C S.D S.E	599.421 599.422 599.423 599.424
16	Schnäpperbolzen Goujon d'encliquetage Bolt for spring-loaded catch	BK-FC SL	bis FFH 880 jusqu'à FFH 880 up to FFH 880	499.458 B.A	599.419
18	Balkontürschnäpper Loqueteau pour porte de balcon Balcony door catch	BK-SL	bis FFH 880 jusqu'à FFH 880 up to FFH 880	499.462 B.C	599.401
24	Flügelager Fiche d'angle du vantail Leaf hinge part	FL.SE.1		499.463 F.A	599.464
23	Flügelagerschiene Crémone fiche d'angle du vantail Leaf hinge part rod	FLS.SE	ab/dès/from 100 kg	499.463 F.B	599.465
25	Drehbegrenzer Compas de limitation d'ouverture Opening limiter	DB.SE.1	ab/dès/from FFB 551	499.463 D.C	599.457
27	Adapterplatte Plaque d'adaptation Adapter plate	AP.SJ.SE.20-9.LS AP.SJ.SE.20-9.RS	ab/dès/from 100 kg links/à gauche/left rechts/à droite/right	499.460 A.C	599.455 599.456
28	Ecklager Charnière inférieure d'angle Corner hinge part	EL.SJ.SE.20-9.Z.LS EL.SJ.SE.20-9.Z.RS	links/à gauche/left rechts/à droite/right	499.460 E.A	599.461 599.462
29	Rahmenanbindung Raccordement au cadre Frame attachment	RA.DB.SE.20-9.LS RA.DB.SE.20-9.RS	ab/dès/from FFB 551	499.460 R.B	599.470 599.471
30	Drehlagerschiene Crémone du compas Pivot hinge rod	DLS.K.SE.9-13		499.464 D.A	599.460
31	Zwangsverriegelung Verrouillage forcé Security locking system	ZV SL	ab/dès/from FFH 901	499.458 Z.B	599.475
32	Drehlager Compas Pivot hinge	DL.SJ.SE.20-9.Z.LS DL.SJ.SE.20-9.Z.RS	links/à gauche/left rechts/à droite/right	499.461 S/D.A	599.458 599.459
33	Schliessblech Gâche Strike plate	SZV SL		499.462 Z.B	599.474
50	Stulpplatte Plaque Connecting piece	ER J SL			599.425
53	Auflauf Appui Lock staple				599.479
55	Kippschliessblech Gâche oscillo-battante Tilt striking plate	SBK.S.9-18.J		499.459 S.A	599.484
56	Sicherheitsschliessblech Gâche de sécurité Security strike plate	SBS.S.9-18.J.LS SBS.S.9-18.J.RS	links/à gauche/left rechts/à droite/right	499.459 S.A	599.482 599.483
60	Schraube / Vis / Screw M4x20				557.045
61	Schraube / Vis / Screw M4x12				557.046
63	Beschlagsunterlage / Cale / Mechanism support				557.050

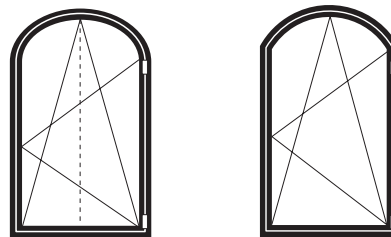
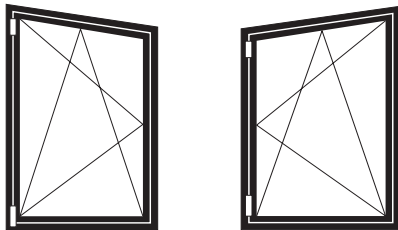
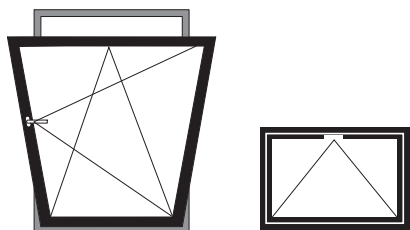

Sonderbestellungen

Folgende Sonderbestellungen sind erhältlich:

RFID

Neue Technologie für die Fensterüberwachung mit beschlagintegrierten Verschluss-Sensoren mit Transponder-technologie (VdS Klasse C)

Kipp vor Dreh

Die Kippfunktion ist der Drehöffnung vorgestellt. Mit einem speziellen TBT-Fenstergriff (Tilt before Turn), der ein Weiterschalten in der Drehstellung nur durch Schlüsselbetätigung erlaubt, kann ein Drehöffnen des Fensters wirkungsvoll unterbunden werden.

Verdeckt liegender Kippbeschlag bis 80 kg

Bestellformular siehe Seite 97

Atelierfenster

Bestellformular siehe Seite 98

Rundbogenfenster

Bestellformular siehe Seite 99

Segmentbogenfenster

Bestellformular siehe Seite 100

Commande spéciale

Les commandes spéciales suivantes sont disponibles:

RFID

Nouvelle technologie de surveillance des fenêtres avec capteurs de fermeture intégrés dans les ferrures et technologie de réponse (VdS classe C)

Ouverture inversée

La fonction de soufflet a la priorité sur celle d'ouverture à la française. Une poignée de fenêtre spéciale TBT (Tilt before Turn) qui n'autorise la position de pivotement qu'avec une clé permet d'empêcher efficacement l'ouverture par rotation de la fenêtre.

Ferrure à soufflet non apparente jusqu'à 80 kg

Formulaire de commande voir page 97

Fenêtre trapézoïdale

Formulaire de commande voir page 98

Fenêtre en demi-rond

Formulaire de commande voir page 99

Fenêtre à arc surbaissé

Formulaire de commande voir page 100

Special order

The following special order are available:

RFID

New technology for window monitoring with closing sensors integrated in the fittings with transponder technology (VdS class C)

Tilt-before-turn

The tilt function comes before the turn function. Using a special TBT window handle (tilt-before-turn), which only allows the turn position to be activated using a key, it is possible to effectively prevent the window from being opened in the turn position.

Concealed bottom-hung fitting to 80 kg

See page 97 for the order form

Studio window

See page 98 for the order form

Arched head window

See page 99 for the order form

Window with segmented arch

See page 100 for the order form

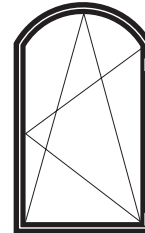
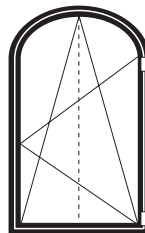
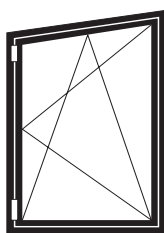
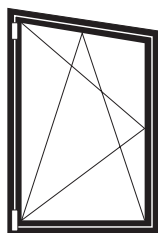
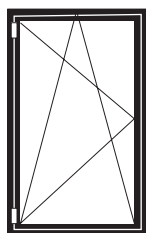

RFID

RFID

RFID

Rahmenbedingungen

Standard-Fensterbeschlag
 Verdeckt liegender Fensterbeschlag
 Rahmenbedingungen gemäss Katalog

Conditions cadres

Ferrure de fenêtre Standard
 Ferrure de fenêtre non apparente
 Conditions cadres selon catalogue

Frame conditions

Standard window fitting
 Concealed window fitting
 Frame conditions according to catalogue

Flügelgrösse

Standard-Fensterbeschlag
 FFB min. = 510 mm
 max. = 1475 mm

Verdeckt liegender Fensterbeschlag
 FFB min. = 750 mm
 max. = 1475 mm

Dimension du vantail

Ferrure de fenêtre Standard
 FFB min. = 510 mm
 max. = 1475 mm

Ferrure de fenêtre non apparente
 FFB min. = 750 mm
 max. = 1475 mm

Vent size

Standard window fitting
 FFB min. = 510 mm
 max. = 1475 mm

Concealed window fitting
 FFB min. = 750 mm
 max. = 1475 mm

Menge: _____

FFB: _____

Quantité: _____

FFB: _____

Quantity: _____

FFB: _____

Bemerkung:

Bohrlehren nur beschränkt einsetzbar.

Remarque:

L'utilisation des gabarits de perçage est limitée.

Note:

Drilling jigs can only be used to a limited extent.

Zusätzlich bestellen:

Befestigungsmaterial

Commander séparément:

Matériel de fixation

Order separately:

Fixings

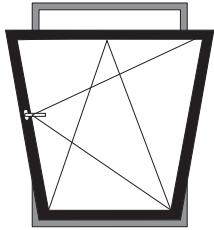

Kipp vor Dreh

Ouverture inversée

Tilt-before-turn

Rahmenbedingungen

Standard-Fensterbeschlag
Verdeckt liegender Fensterbeschlag
Rahmenbedingungen gemäss Katalog

Conditions cadres

Ferrure de fenêtre Standard
Ferrure de fenêtre non apparente
Conditions cadres selon catalogue

Frame conditions

Standard window fitting
Concealed window fitting
Frame conditions according to catalogue

Flügelgrösse

Standard-Fensterbeschlag
FFB min. = 370 mm
max. = 1475 mm
FFH min. = 575 mm
max. = 2300 mm

Dimension du vantail

Ferrure de fenêtre Standard
FFB min. = 370 mm
max. = 1475 mm
FFH min. = 575 mm
max. = 2300 mm

Vent size

Standard window fitting
FFB min. = 370 mm
max. = 1475 mm
FFH min. = 575 mm
max. = 2300 mm

Verdeckt liegender Fensterbeschlag

FFB min. = 480 mm
max. = 1475 mm
FFH min. = 575 mm
max. = 2300 mm

Ferrure de fenêtre non apparente

FFB min. = 480 mm
max. = 1475 mm
FFH min. = 575 mm
max. = 2300 mm

Concealed window fitting

FFB min. = 480 mm
max. = 1475 mm
FFH min. = 575 mm
max. = 2300 mm

Menge: _____

Quantité: _____

Quantity: _____

DIN links/rechts: _____

DIN gauche/droite: _____

DIN left/right: _____

FFB: _____ mm

FFB: _____ mm

FFB: _____ mm

FFH: _____ mm

FFH: _____ mm

FFH: _____ mm

G-Mass: _____ mm

Mesure G: _____ mm

G measurement: _____ mm

Bemerkung:

Bohrlehren nur beschränkt einsetzbar.

Remarque:

L'utilisation des gabarits de perçage est limitée.

Note:

Drilling jigs can only be used to a limited extent.

Zusätzlich bestellen:

Befestigungsmaterial, Fenstergriff, zusätzliche Beschläge

Commander séparément:

Matériel de fixation, poignée de fenêtre, ferrures supplémentaires

Order separately:

Fixings, window handle, additional fittings

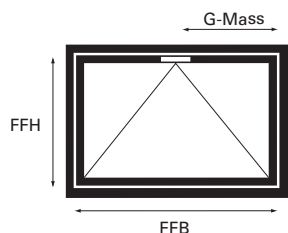

Kippfenster	Fenêtre à soufflet	Bottom-hung window
-------------	--------------------	--------------------

Rahmenbedingungen

Verdeckt liegender Beschlag
 Max. Gewicht 80 kg
 Max. Fläche 3.0 m²
 Max. Seitenverhältnis FFB/FFH: 1:1
 G-Mass immer mittig wählen

Conditions cadres

Ferrure non apparente
 Poids max. 80 kg
 Surface max. 3.0 m²
 Rapport latéral max FFB/FFH: 1:1
 Toujours choisir une mesure G centrée

Frame conditions

Concealed fitting
 Max. weight 80 kg
 Max. area 3.0 m²
 Maximum ratio of sides, vent rebate width/vent rebate height: 1:1
 For the G measurement, always select the value in the middle

Flügelgröße

FFB min. = 575 mm
 max. = 1500 mm
 FFH min. = 600 mm
 max. = 2300 mm

Dimension du vantail

FFB min. = 575 mm
 max. = 1500 mm
 FFH min. = 600 mm
 max. = 2300 mm

Vent size

FFB min. = 575 mm
 max. = 1500 mm
 FFH min. = 600 mm
 max. = 2300 mm

Menge: _____

Quantité: _____

Quantity: _____

FFB: _____ mm

FFB: _____ mm

FFB: _____ mm

FFH: _____ mm

FFH: _____ mm

FFH: _____ mm

G-Mass: _____ mm

Mesure G: _____ mm

G measurement: _____ mm

G-Mass immer mittig wählen.

La mesure G devrait être choisie centrée.

For the G measurement, always select the value in the middle.

Bemerkung:

Bohrlehren nur beschränkt einsetzbar.

Remarque:

L'utilisation des gabarits de perçage est limitée.

Note:

Drilling jigs can only be used to a limited extent.

Zusätzlich bestellen:

Befestigungsmaterial, Fenstergriff, zusätzliche Beschläge

Commander séparément:

Matériel de fixation, poignée de fenêtre, ferrures supplémentaires

Order separately:

Fixings, window handle, additional fittings

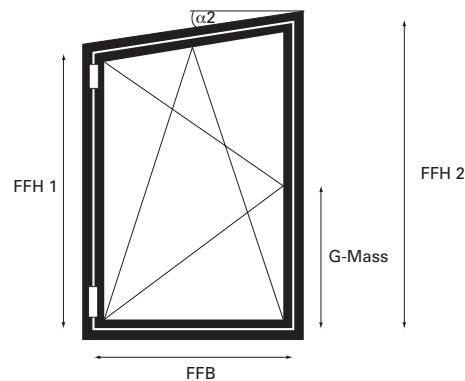
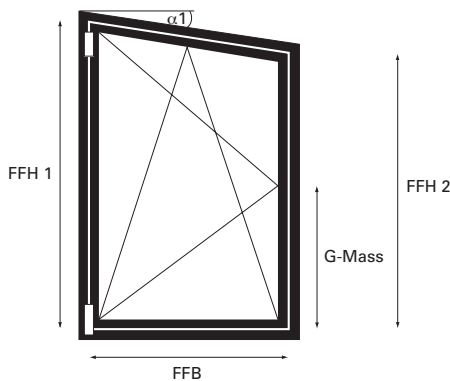

Atelierfenster

Fenêtre trapézoïdale

Studio window

Rahmenbedingungen

Standard-Beschlag
 Max. Gewicht 80 kg
 Max. Fläche 2.0 m²
 Max. Seitenverhältnis FF B/FFH: 1:1
 G-Mass min. 288 mm

Conditions cadres

Ferrure Standard
 Poids max. 80 kg
 Surface max. 2.0 m²
 Rapport latéral max FF B/FFH: 1:1
 Mesure G min. 288 mm

Frame conditions

Standard fitting
 Max. weight 80 kg
 Max. area 2.0 m²
 Maximum ratio of sides, vent rebate width/vent rebate height: 1:1
 Min. G measurement 288 mm

Flügelgröße

FFB min. = 370 mm
 max. = 1250 mm
 schräg max. 1475 mm
 FFH1 min. = 575 mm
 min. = 665 mm ($\alpha 2 \leq 45^\circ$)
 max. = 2300 mm
 FFH2 min. = 575 mm
 max. = 2300 mm
 Winkel: $\alpha 1$ (max. 20°)
 $\alpha 2$ (max. 45°)

Dimension du vantail

FFB min. = 370 mm
 max. = 1250 mm
 incliné max. 1475 mm
 FFH1 min. = 575 mm
 min. = 665 mm ($\alpha 2 \leq 45^\circ$)
 max. = 2300 mm
 FFH2 min. = 575 mm
 max. = 2300 mm
 Cornière: $\alpha 1$ (max. 20°)
 $\alpha 2$ (max. 45°)

Vent size

FFB min. = 370 mm
 max. = 1250 mm
 sloping max. 1475 mm
 FFH1 min. = 575 mm
 min. = 665 mm ($\alpha 2 \leq 45^\circ$)
 max. = 2300 mm
 FFH2 min. = 575 mm
 max. = 2300 mm
 Angle: $\alpha 1$ (max. 20°)
 $\alpha 2$ (max. 45°)

Menge: _____

Quantité: _____

Quantity: _____

Öffnungsrichtung D/DK: _____

Direction d'ouverture F/OB: _____

Direction of opening SH/TT: _____

DIN links/rechts: _____

DIN gauche/droite: _____

DIN LH/RH: _____

FFB: _____ mm

FFB: _____ mm

FFB: _____ mm

FFH 1: _____ mm

FFH 1: _____ mm

FFH 1: _____ mm

FFH 2: _____ mm

FFH 2: _____ mm

FFH 2: _____ mm

G-Mass: _____ mm

Mesure G: _____ mm

G measurement: _____ mm

Winkel $\alpha 1$ ($\leq 20^\circ$) _____

Cornière $\alpha 1$ ($\leq 20^\circ$) _____

Angle $\alpha 1$ ($\leq 20^\circ$) _____

$\alpha 2$ ($\leq 45^\circ$) _____

$\alpha 2$ ($\leq 45^\circ$) _____

$\alpha 2$ ($\leq 45^\circ$) _____

Bemerkung:

Bohrlehren nur beschränkt einsetzbar.

Remarque:

L'utilisation des gabarits de perçage est limitée.

Note:

Drilling jigs can only be used to a limited extent.

Zusätzlich bestellen:

Befestigungsmaterial, Fenstergriff, zusätzliche Beschläge

Commander séparément:

Matériel de fixation, poignée de fenêtre, ferrures supplémentaires

Order separately:

Fixings, window handle, additional fittings

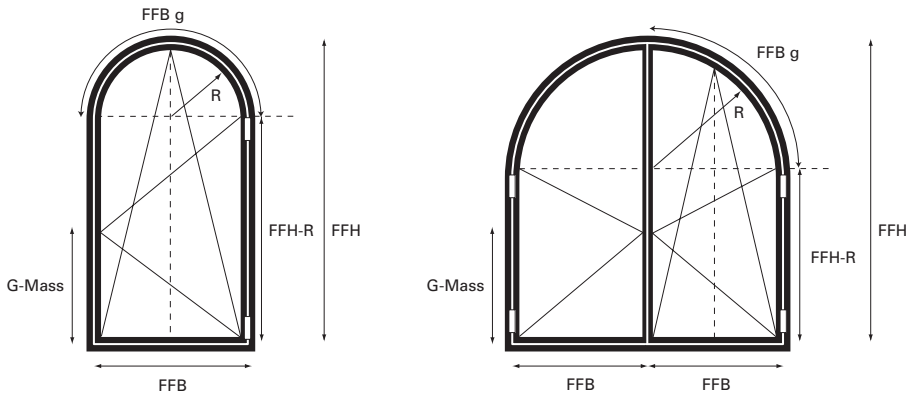

Rundbogenfenster

Fenêtre en demi-rond

Arched head window

Rahmenbedingungen

Standard-Beschlag
 Max. Gewicht 80 kg
 Max. Fläche 2.0 m²
 Max. Seitenverhältnis FFB/FFH: 1:1
 G-Mass min. 288 mm

Conditions cadres

Ferrure Standard
 Poids max. 80 kg
 Surface max. 2.0 m²
 Rapport latéral max FFB/FFH: 1:1
 Mesure G min. 288 mm

Frame conditions

Standard fitting
 Max. weight 80 kg
 Max. area 2.0 m²
 Maximum ratio of sides, vent rebate width/vent rebate height: 1:1
 Min. G measurement 288 mm

Flügelgröße

FFB min. = 370 mm
 max. = 1150 mm
 FFH-R min. = 575 mm (1-flügelig)
 max. = 1800 mm
 FFH min. = 881 mm (2-flügelig)
 max. = 2300 mm

Dimension du vantail

FFB min. = 370 mm
 max. = 1150 mm
 FFH-R min. = 575 mm (1 vantail)
 max. = 1800 mm
 FFH min. = 881 mm (2 vantaux)
 max. = 2300 mm

Vent size

FFB min. = 370 mm
 max. = 1150 mm
 FFH-R min. = 575 mm (single leaf)
 max. = 1800 mm
 FFH min. = 881 mm (double leaf)
 max. = 2300 mm

Menge: _____

Quantité: _____

Quantity: _____

1- oder 2-flügelig: _____

1 ou 2 vantaux: _____

1 or 2 leaf: _____

Öffnungsrichtung D/DK: _____
 (erstöffnender Flügel)

Direction d'ouverture F/OB: _____
 (vantail ouvrant en premier)

Direction of opening SH/TT: _____
 (vent which opens first)

DIN links/rechts: _____
 (erstöffnender Flügel)

DIN gauche/droite: _____
 (vantail ouvrant en premier)

DIN LH/RH: _____
 (vent which opens first)

FFB: _____ mm

FFB: _____ mm

FFB: _____ mm

FFB g: _____ mm

FFB g: _____ mm

FFB g: _____ mm

FFH-R: _____ mm

FFH-R: _____ mm

FFH-R: _____ mm

G-Mass: _____ mm

Mesure G: _____ mm

G measurement: _____ mm

R: _____

R: _____

R: _____

Bemerkung:

Bohrlehren nur beschränkt einsetzbar.

Remarque:

L'utilisation des gabarits de perçage est limitée.

Note:

Drilling jigs can only be used to a limited extent.

Zusätzlich bestellen:

Befestigungsmaterial, Fenstergriff, zusätzliche Beschläge

Commander séparément:

Matériel de fixation, poignée de fenêtre, ferrures supplémentaires

Order separately:

Fixings, window handle, additional fittings

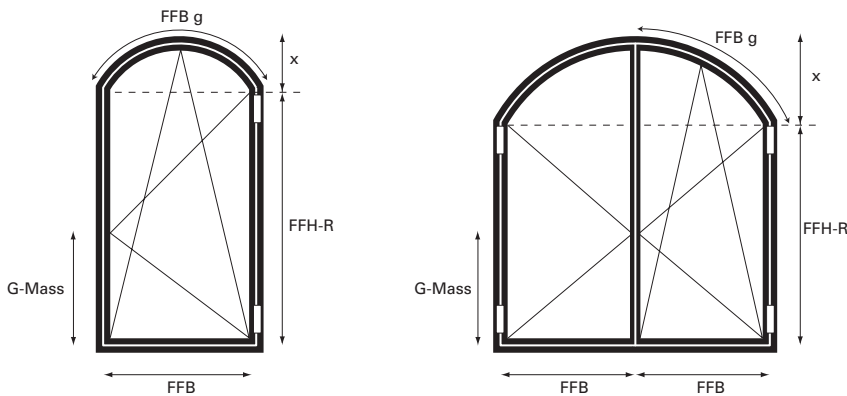

Segmentbogenfenster 1

Fenêtre à arc surbaissé 1

Window with segmented arch 1

Rahmenbedingungen

Standard-Beschlag
 Max. Gewicht 80 kg
 Max. Fläche 2.0 m²
 Max. Seitenverhältnis FFB/FFH: 1:1
 G-Mass min. 288 mm
 $x \leq 10\%$ FFB

Conditions cadres

Ferrure Standard
 Poids max. 80 kg
 Surface max. 2.0 m²
 Rapport latéral max FFB/FFH: 1:1
 Mesure G min. 288 mm
 $x \leq 10\%$ FFB

Frame conditions

Standard fitting
 Max. weight 80 kg
 Max. area 2.0 m²
 Maximum ratio of sides, vent rebate width/vent rebate height: 1:1
 Min. G measurement 288 mm
 $x \leq 10\%$ FFB

Flügelgröße

FFB min. = 370 mm
 max. = 1250 mm
 FFH-R min. = 575 mm (1-flügelig)
 FFH-R+x min. = 881 mm (2-flügelig)
 max. = 2300 mm

Dimension du vantail

FFB min. = 370 mm
 max. = 1250 mm
 FFH-R min. = 575 mm (1 vantail)
 FFH-R+x min. = 881 mm (2 vantaux)
 max. = 2300 mm

Vent size

FFB min. = 370 mm
 max. = 1250 mm
 FFH-R min. = 575 mm (single leaf)
 FFH-R+x min. = 881 mm (double leaf)
 max. = 2300 mm

Menge: _____

Quantité: _____

Quantity: _____

1- oder 2-flügelig: _____

1 ou 2 vantaux: _____

1 or 2 leaf: _____

Öffnungsrichtung D/DK: _____
 (erstöffnender Flügel)

Direction d'ouverture F/OB: _____
 (vantail ouvrant en premier)

Direction of opening SH/TT: _____
 (vent which opens first)

DIN links/rechts: _____
 (erstöffnender Flügel)

DIN gauche/droite: _____
 (vantail ouvrant en premier)

DIN LH/RH: _____
 (vent which opens first)

FFB: _____ mm

FFB: _____ mm

FFB: _____ mm

FFB g: _____ mm

FFB g: _____ mm

FFB g: _____ mm

FFH-R: _____ mm

FFH-R: _____ mm

FFH-R: _____ mm

G-Mass: _____ mm

Mesure G: _____ mm

G measurement: _____ mm

x: _____ mm

x: _____ mm

x: _____ mm

Bemerkung:

Bohrlehren nur beschränkt einsetzbar.

Remarque:

L'utilisation des gabarits de perçage est limitée.

Note:

Drilling jigs can only be used to a limited extent.

Zusätzlich bestellen:

Befestigungsmaterial, Fenstergriff, zusätzliche Beschläge

Commander séparément:

Matériel de fixation, poignée de fenêtre, ferrures supplémentaires

Order separately:

Fixings, window handle, additional fittings

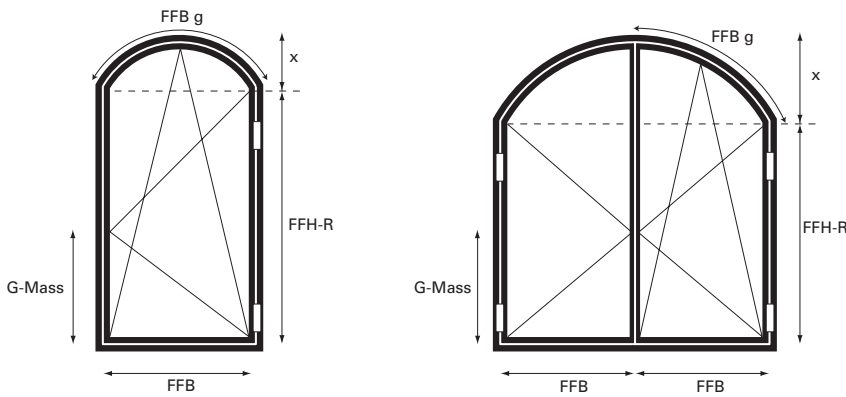

Segmentbogenfenster 2

Fenêtre à arc surbaissé 2

Window with segmented arch 2

Rahmenbedingungen

Standard-Beschlag
 Max. Gewicht 80 kg
 Max. Fläche 2.0 m²
 Max. Seitenverhältnis FFB/FFH: 1:1
 G-Mass min. 288 mm
 $x \geq 10\%$ FFB

Conditions cadres

Ferrure Standard
 Poids max. 80 kg
 Surface max. 2.0 m²
 Rapport latéral max FFB/FFH: 1:1
 Mesure G min. 288 mm
 $x \geq 10\%$ FFB

Frame conditions

Standard fitting
 Max. weight 80 kg
 Max. area 2.0 m²
 Maximum ratio of sides, vent rebate width/vent rebate height: 1:1
 Min. G measurement 288 mm
 $x \geq 10\%$ FFB

Flügelgröße

FFB min. = 370 mm
 max. = 1150 mm
 FFH-R min. = 665 mm
 max. = 1800 mm
 FFH-R+x min. = 881 mm (2-flügelig)
 max. = 2300 mm

Dimension du vantail

FFB min. = 370 mm
 max. = 1150 mm
 FFH-R min. = 665 mm
 max. = 1800 mm
 FFH-R+x min. = 881 mm (2 vantaux)
 max. = 2300 mm

Vent size

FFB min. = 370 mm
 max. = 1150 mm
 FFH-R min. = 665 mm
 max. = 1800 mm
 FFH-R+x min. = 881 mm (double leaf)
 max. = 2300 mm

Menge: _____

Quantité: _____

Quantity: _____

1- oder 2-flügelig: _____

1 ou 2 vantaux: _____

1 or 2 leaf: _____

Öffnungsrichtung D/DK: _____
 (erstöffnender Flügel)

Direction d'ouverture F/OB: _____
 (vantail ouvrant en premier)

Direction of opening SH/TT: _____
 (vent which opens first)

DIN links/rechts: _____
 (erstöffnender Flügel)

DIN gauche/droite: _____
 (vantail ouvrant en premier)

DIN LH/RH: _____
 (vent which opens first)

FFB: _____ mm

FFB: _____ mm

FFB: _____ mm

FFB g _____ mm

FFB g _____ mm

FFB g _____ mm

FFH-R: _____ mm

FFH-R: _____ mm

FFH-R: _____ mm

G-Mass: _____ mm

Mesure G: _____ mm

G measurement: _____ mm

x: _____ mm

x: _____ mm

x: _____ mm

Bemerkung:

Bohrlehren nur beschränkt einsetzbar.

Remarque:

L'utilisation des gabarits de perçage est limitée.

Note:

Drilling jigs can only be used to a limited extent.

Zusätzlich bestellen:

Befestigungsmaterial, Fenstergriff, zusätzliche Beschläge

Commander séparément:

Matériel de fixation, poignée de fenêtre, ferrures supplémentaires

Order separately:

Fixings, window handle, additional fittings

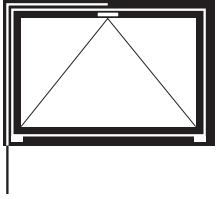

Oberlichtöffner F200

Ferrure d'imposte F200

Top light opener F200

Flügelanordnung

Dispositions des vantaux

Arrangement of sashes

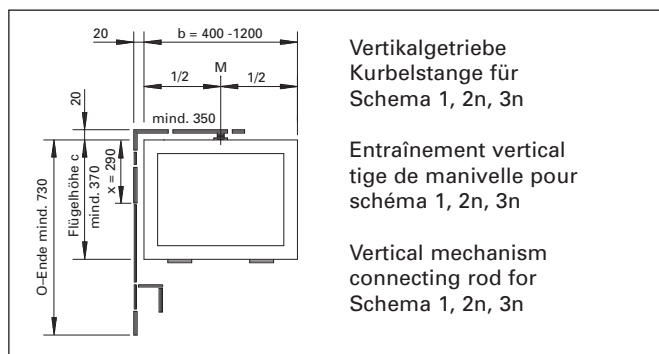
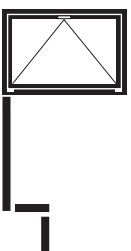
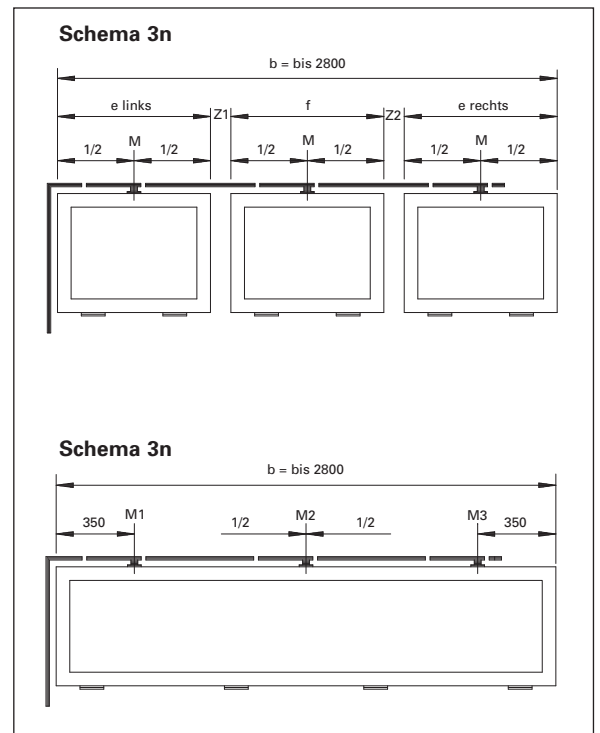
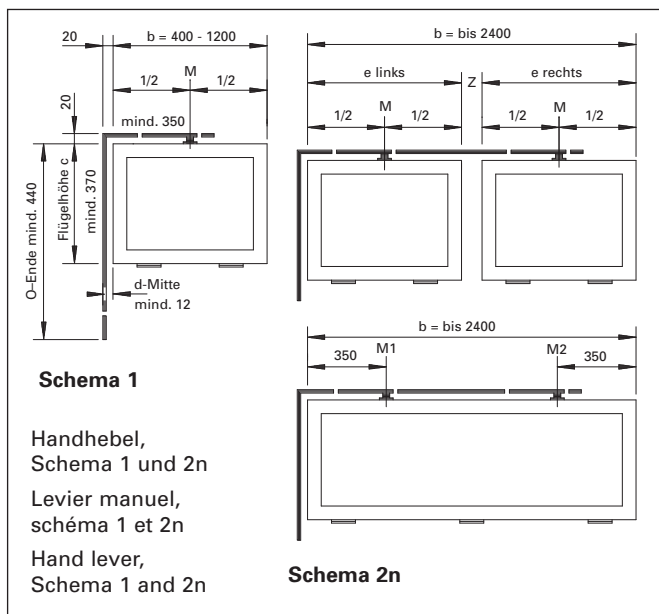
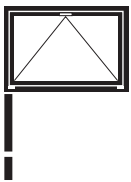

Flügelbreite Mass b

400 – 1200 mm = 1 Schere, Schema 1
 1201 – 2400 mm = 2 Scheren, Schema 2n
 2401 – 2800 mm = 3 Scheren, Schema 3n

Largeur du vantail, mesure b

400 – 1200 mm = 1 compas, schéma 1
 1201 – 2400 mm = 2 compas, schéma 2n
 2401 – 2800 mm = 3 compas, schéma 3n

Sash width b

400 – 1200 mm = 1 stay, schema 1
 1201 – 2400 mm = 2 stays, schema 2n
 2401 – 2800 mm = 3 stays, schema 3n

Oberlichtöffner F200
Ferrure d'imposte F200
Top light opener F200

Jansen-Economy 50 Fenster
 Jansen-Economy 50 fenêtres
 Jansen-Economy 50 windows

Bestellangaben
Oberlichtöffner F200

Flügelhöhe Mass c

mind.: 370 mm
 max.: 1000 mm
 Hub: 50 mm
 Gewicht: 120 kg
Öffnungsweite: 200 mm

Platzbedarf bei Handhebel
 seitlich und oben 20 mm

Bedienung Handhebel

Benennung	Schema		
	1	2n	3n
550.651 Grundbeschlag mit Handhebel, Eckumlenkung, Öffnerschere und Winkel-Flügelstütze	1	1	1
550.652 Zusatzschere mit Winkel-Flügelstütze		1	2
Zug- und Querstange ø 8 mm mit Alu-Abdeckprofil			
550.641 Länge 1850 mm	1	1	1
550.642 Länge 3300 mm	1	1	1
550.649 Muffe für Stangenkupplung ø 8 mm			

Bedienung
Vertikal-Getriebe Kurbelstange

Benennung	Schema		
	1	2n	3n
550.653 Grundbeschlag mit Eckwinkel, Öffnerschere und Winkel-Flügelstütze	1	1	1
550.652 Zusatzschere mit Winkel-Flügelstütze		1	2
Zug- und Querstange ø 8 mm mit Alu-Abdeckprofil			
550.641 Länge 1850 mm	1	1	1
550.642 Länge 3300 mm	1	1	1
550.643 Vertikalgetriebe mit Kreuzgelenk	1	1	1
550.644 Knickkurbel mit Kurbelhalter	1	1	1
550.650 Kurbelstange Länge 5000 mm	1	1	1
550.649 Muffe für Stangenkupplung ø 8 mm			

Données de commande
Ferrure d'imposte F200

Hauteur du vantail, mesure c

min.: 370 mm
 max.: 1000 mm
 Course: 50 mm
 Poids: 120 kg
Largeur d'ouverture: 200 mm

Encombrement avec levier manuel
 sur le côté ou en haut 20 mm

Actionnement par levier manuel

Désignation	Schéma		
	1	2n	3n
550.651 Ferrure de base avec levier manuel, renvoi d'angle, compas d'ouverture et palier d'accrochage équerre	1	1	1
550.652 Compas d'ouverture avec palier d'accrochage en équerre		1	2
Tringle de tirage ø 8 mm avec profilé			
550.641 Longueur 1850 mm	1	1	1
550.642 Longueur 3300 mm	1	1	1
550.649 Douille d'accouplement ø 8 mm			

Actionnement par entraînement
vertical tige de manivelle

Désignation	Schéma		
	1	2n	3n
550.653 Ferrure de base avec renvoi d'angle compas d'ouverture et palier d'accrochage en équerre	1	1	1
550.652 Compas d'ouverture avec palier d'accrochage en équerre		1	2
Tringle de tirage ø 8 mm avec profilé			
550.641 Longueur 1850 mm	1	1	1
550.642 Longueur 3300 mm	1	1	1
550.643 Entraînement vertical avec joint universel	1	1	1
550.644 Manivelle articulée avec support	1	1	1
550.650 Tige de manivelle longueur 5000 mm	1	1	1
550.649 Douille d'accouplement ø 8 mm			

Details for order
Top light opener F200

Sash height c

min.: 370 mm
 max.: 1000 mm
 Travel: 50 mm
 Weight: 120 kg
Opening width: 200 mm

Space required with hand lever
 at side and top 20 mm

Operation with hand lever

Designation	Schema		
	1	2n	3n
550.651 Basic set of fittings with hand lever, corner guides, opener stay, and corner sash support	1	1	1
550.652 Opener stay with corner sash support		1	2
Vertical and horizontal rods ø 8 mm with alu cover section			
550.641 Length 1850 mm	1	1	1
550.642 Length 3300 mm	1	1	1
550.649 Sleeve for rod coupling ø 8 mm			

Operation with vertical control
mechanism connecting rod

Designation	Schema		
	1	2n	3n
550.653 Basic set of fittings with corner guides, opener stay and corner sash support	1	1	1
550.652 Opener stay with corner sash support		1	2
Vertical and horizontal rods ø 8 mm with alu cover section			
550.641 Length 1850 mm	1	1	1
550.642 Length 3300 mm	1	1	1
550.643 Vertical drive rod with universal joint	1	1	1
550.644 Articulated crank with crank holder	1	1	1
550.650 Connecting rod length 5000 mm	1	1	1
550.649 Sleeve for rod coupling ø 8 mm			

Oberlichtöffner motorisiert
Ferrure d'imposte motorisée
Top light opener motorized

Jansen-Economy 50 Fenster
 Jansen-Economy 50 fenêtres
 Jansen-Economy 50 windows

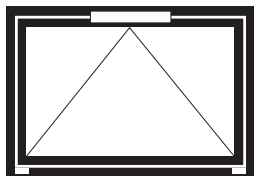

Oberlichtöffner motorisiert

Ferrure d'imposte motorisés

Top light opener motorized

	EM/2	FM
	550.960 Hub / Course / Lift distance 327 mm 550.961 Hub / Course / Lift distance 603 mm	550.689 Hub / Course / Lift distance 600 mm
Nennspannung Tension nominale Rated voltage	24V DC (-20% / +25%)	24V DC (-10% / +25%)
Nennstrom Courant nominal Rated current	ca. 1.0 A	ca. 1.8 A
Abschaltung AUF Arrêt OUVERT OPEN cut-out	Eingebauter Endschalter Fin de course monté Built-in end switch	
Abschaltung ZU Arrêt FERMÉ CLOSE cut-out	Integrierte elektrische Lastabschaltung Coupure en charge électrique intégrée Integrated electrical load cut-off	
Zug- und Druckkraft Force de traction et de pression Traction and thrust	300 N	600 N
Nennverriegelungskraft Force de verrouillage nominale Nominal locking force	3000 N	
Laufgeschwindigkeit Vitesse de déplacement Operating speed	ca. 12 mm/s	ca. 10 mm/s
Einschaltdauer Durée de mise en circuit Duty cycle	3 min. Ein, 7 min. Aus 3 min. marche, 7 min. arrêt 3 min. on, 7 min. off	1 min. Ein, 2 min. Aus 1 min. marche, 2 min. arrêt 1 min. on, 2 min. off
Anschlussleitung Câble de raccordement Connecting cable	3 polig, Länge 3 m 3 pôles, longueur 3 m 3-core, length 3 m	2 polig, Länge 3 m 2 pôles, longueur 3 m 2-core, length 3 m

Alle Kettenmotoren sind für
RWA-Anlagen geeignet

Tous les moteurs de chaîne
conviennent aux installations RWA

All chain motors are suitable for
SHEVS installations

Oberlichtöffner motorisiert
Ferrure d'imposte motorisée
Top light opener motorized

Jansen-Economy 50 Fenster
 Jansen-Economy 50 fenêtres
 Jansen-Economy 50 windows

	EM/2 550.960 Hub / Course / Lift distance 327 mm 550.961 Hub / Course / Lift distance 603 mm	FM 550.689 Hub / Course / Lift distance 600 mm
Umgebungstemperatur Température ambiante Ambient temperature	-10°C bis + 60°C -10°C jusqu'à + 60°C -10°C up to + 60°C	
Schutzart Type de protection Protection rating	IP 20 nach EN 60259 IP 20 selon EN 60259 IP 20 in accordance with EN 60259	
CE-Konformität Conformité CE CE conformity	Gemäss EMV-Richtlinie 2004/108/EG und der Niederspannungsrichtlinie 2006/95 EG Selon la directive sur la compatibilité électromagnétique 2004/108/CE et la directive basse tension 2006/95 CE In accordance with the EMC Directive 2004/108/EC and the Low Voltage Directive 2006/95/EC	
Ausstellmechanik Mécanique d'ouverture Opening mechanism	Nirostahlkette, wartungsfrei Chaîne en acier inoxydable, sans maintenance Stainless steel chain, maintenance-free	
Gehäuse Corps Casing	Aluminium Aluminium Aluminium	
Aussenmontage Montage extérieur Outside installation	nicht geeignet non approprié not suitable	
Flügelgewicht Poids de vantail Leaf weight	max. 120 kg aufliegende Kippbänder oder Anschweissbänder (bei Kippflügeln mit 1-Punkt-Zuhaltung Sicherungsscheren verwenden) Charnières à soufflet ou à souder en applique (max. 120 kg) (pour les charnières à soufflet avec un blocage 1 point, utiliser un système de sécurité en ciseaux) Max. 120 kg surface-mounted bottom-hung hinges or weld-on hinges (for bottom-hung vents with single-point closure, use a security stay)	

Sonderbestellung

Ausführungen:

EM/2 als Tandem
mit Hub 327 mm oder 603 mm

FM als Tandem

Commande spéciale

Exécutions:

EM/2 sous forme de tandem
avec course 327 mm ou 603 mm

FM sous forme de tandem

Special order

Versions:

EM/2 as tandem with lift distance
327 mm or 603 mm

FM as tandem

Oberlichtöffner motorisiert
 Ferrure d'imposte motorisée
 Top light opener motorized

Jansen-Economy 50 Fenster
 Jansen-Economy 50 fenêtres
 Jansen-Economy 50 windows



550.960 Hub 327 mm
550.961 Hub 603 mm

Kettenantrieb EM/2
 für Kippfenster, Aluminium
 silbergrau pulverbeschichtet

VE = 1 Antrieb

550.960 Course 327 mm
550.961 Course 603 mm

Entraînement à chaîne EM/2
 pour fenêtre à soufflet,
 aluminium revêtement par
 poudre gris argent

UV = 1 entraînement

550.960 Lift distance 327 mm
550.961 Lift distance 603 mm

Chain drive EM/2
 for tilt, top-hung, aluminium
 silver-grey powder coated

PU = 1 drive

Art.-Nr. No d'art. Part no.	Hublänge Course Lift distance	LxHxT mm	min. FFB / FFH Kippflügel min. FFB / FFH Vantail à soufflet min. FFB / FFH Tilt window
550.960	327 mm	544 x 40 x 40	521 x 510 mm
550.961	603 mm	820 x 40 x 40	797 x 840 mm



550.963
Konsolenset Rahmen
 für EM/2, Motor auf Rahmen
 montiert, Aluminium silbergrau
 pulverbeschichtet

VE = 1 Konsolenset

550.963
Ensemble console cadre
 pour EM/2, moteur monté sur
 le cadre, aluminium revêtement
 par poudre gris argent

UV = 1 ensemble console

550.963
Bracket kit for frame
 for EM/2, motor mounted on
 the frame, aluminium silver-grey
 powder coated

PU = 1 bracket kit



550.964
Konsolenset Flügel
 für EM/2, Motor auf Flügel
 montiert, Aluminium silbergrau
 pulverbeschichtet

VE = 1 Konsolenset

Zusätzlich bestellen:
 550.692 Kabelübergang

550.964
Ensemble console vantail
 pour EM/2, moteur monté sur
 le vantail, aluminium revêtement
 par poudre gris argent

UV = 1 ensemble console

Commander séparément:
 550.692 Passage de câble

550.964
Bracket kit for vent
 for EM/2, motor mounted on
 the vent, aluminium silver-grey
 powder coated

PU = 1 bracket kit

Order separately:
 550.692 Cable transition

Oberlichtöffner motorisiert
Ferrure d'imposte motorisée
Top light opener motorized

Jansen-Economy 50 Fenster
 Jansen-Economy 50 fenêtres
 Jansen-Economy 50 windows



550.689 Hub 600 mm
Kettenantrieb FM
 für Kippfenster, Aluminium
 silbergrau pulverbeschichtet,
 auf Flügel montiert

VE = 1 Antrieb
 1 Konsolenset

Zusätzlich bestellen:
 550.692 Kabelübergang

550.689 Course 600 mm
Entraînement à chaîne FM
 pour fenêtre à soufflet, aluminium
 revêtement par poudre gris
 argent, monté sur le cadre

UV = 1 entraînement
 1 set de montage

Commander séparément:
 550.692 Passage de câble

550.689 Lift distance 600 mm
Chain drive FM
 for tilt windows, aluminium
 silver-grey powder coated,
 mounted on the frame

PU = 1 drive
 1 installation set

Order separately:
 550.692 Cable transition

Art.-Nr. No d'art. Part no.	Hublänge Course Lift distance	LxHxT mm	min. FFB / FFH Kippflügel min. FFB / FFH Vantail à soufflet min. FFB / FFH Tilt window
550.689	600 mm	744 x 100.5 x 66	750 x 1000 mm



550.692
Kabelübergang
 für 24 V DC geeignet, trennbar
 über Steckfunktion mit Sicher-
 heitsschraube, Kabelübergang
 mit Federummantelung, verdeckt
 liegend im Falz montierbar,
 inkl. 2 x 2,5 m Kabel

VE = 1 Stück

Nenndaten
 Bemessungsspannung: 24 V DC
 Kontaktbelastbarkeit: 2 A
 Anschlussart: 5-adrig
 Kabelquerschnitt: 5 x 0,14 mm²
 Abmessungen: ø 4,5 mm
 Federlänge: 160 mm

550.692
Passage de câble
 convenant à 24 V CC, séparable
 par fonction enfichable avec vis
 de sécurité, passage de câble
 avec gaine ressort, à monter
 de façon non apparente dans
 feuillure, 2 x 2,5 m câbles incl.

UV = 1 pièce à 5 m

Données nominales
 Tension de mesure: 24 V CC
 Capacité de charge contact: 2 A
 Type de raccordement: à 5 brins
 Diamètre de câble: 5 x 0,14 mm²
 Dimensions: ø 4,5 mm
 Longueur ressort: 160 mm

550.692
Cable transition
 suitable for 24 V DC,
 separatable using plug feature
 with safety screw, cable
 transition with spring cladding,
 can be mounted hidden in fold,
 incl 2 x 2.5 m cable

PU = 1 piece, 5 m each

Characteristics
 Rating: 24 V DC
 Contact load: 2 A
 Connection type: 5 wires
 Cable cross section: 5 x 0.14 mm²
 Dimensions: ø 4.5 mm
 Spring length: 160 mm

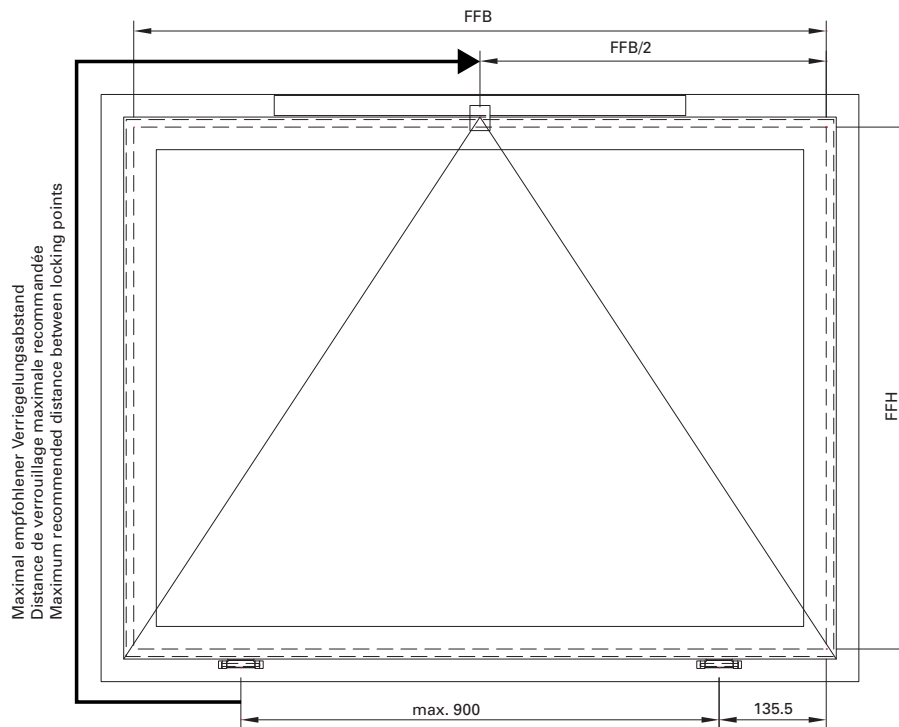

Maximal empfohlener Verriegelungsabstand: 1500 mm

Distance de verrouillage maximale recommandée: 1500 mm

Maximum recommended distance between locking points: 1500 mm

Gewicht pro Kippflügelband (Standard-Beschlag): 40 kg (120 kg pro Flügel)

Poids par paumelle de vantail à soufflet (Ferrure Standard): 40 kg (120 kg par vantail)

Weight per hinge for bottom-hung vent (Standard fitting): 40 kg (120 kg per vent)

Formel:

$$135.5 \text{ mm} + \text{FFH} + \text{FFB}/2 = \text{max. } 1500 \text{ mm}$$

Formule:

$$135.5 \text{ mm} + \text{FFH} + \text{FFB}/2 = \text{max. } 1500 \text{ mm}$$

Formula:

$$135.5 \text{ mm} + \text{FFH} + \text{FFB}/2 = \text{max. } 1500 \text{ mm}$$

Flügel mit 1 Motor

Vantail avec 1 moteur

Vent with 1 motor

Art.-Nr. No d'art. Part no.	Antrieb Entraînement Drive	Hub Course Lift distance	FFB min.	FFH min.
550.960	EM/2	327 mm	521 mm	510 mm
550.961	EM/2	603 mm	797 mm	840 mm
550.689	FM	600 mm	750 mm	1000 mm

Für Kippflügel mit nur 1 Verriegelungspunkt (manuell oder motorisch) zusätzlich bestellen:

557.220 Sicherungsschere 300 oder
 557.221 Sicherungsschere 600

Pour le vantail à soufflet ne possédant que 1 point de verrouillage (manuel ou motorisé), commander de plus:

557.220 Compas de sécurité 300 ou
 557.221 Compas de sécurité 600

For bottom-hung vents with only 1 locking point (manually or motorized), also order:

557.220 Security stay 300 or
 557.221 Security stay 600



557.050

Beschlagunterlage

Federstahl, als Beschlag-
unterlage in der Nute
vom Flügelprofil

VE = 10 Stück

557.050

Cale

acier à ressorts, pour la
rainure du profilé de vantail

UV = 10 pièces

557.050

Mechanism supprt

spring steel, into the groove
of the leaf profil

PU = 10 pieces



557.045

Schraube M4x20

Stahl verzinkt, SR1-Angriff,
selbstgewindend, für
Beschlagteile Flügelrahmen
und Schliessbleche

Bohrdurchmesser 3,5 mm

VE = 100 Stück

557.045

Vis M4x20

acier zingué, empreinte SR1,
autotaraudeuse, pour ferrures
du cadre ouvrant et gâches
de fermeture

Diamètre de perçage 3,5 mm

UV = 100 pièces

557.045

Screw M4x20

galvanised steel, SR1 head,
self-tapping, for fittings on
leaf frame and strike plates

Hole diameter 3.5 mm

PU = 100 pieces



557.046

Schraube M4x12

Stahl verzinkt, SR1-Angriff,
selbstgewindend, für
Beschlagteile Rahmen

Bohrdurchmesser 3,5 mm

VE = 100 Stück

557.046

Vis M4x12

acier zingué, empreinte SR1,
autotaraudeuse, pour les
pièces de ferrure cadre

Diamètre de perçage 3,5 mm

UV = 100 pièces

557.046

Screw M4x12

galvanised steel, SR1 head,
self-tapping, for frame
fittings components

Hole diameter 3.5 mm

PU = 100 pieces



557.048

Schraube M4x27

Stahl verzinkt, SR1-Angriff,
selbstgewindend, für
Befestigung der Falzschere

Bohrdurchmesser 3,5 mm

VE = 50 Stück

557.048

Vis M4x27

acier zingué, empreinte SR1,
autotaraudeuse, pour la
fixation des compas d'arrêt

Diamètre de perçage 3,5 mm

UV = 50 pièces

557.048

Screw M4x27

galvanised steel, SR1 head,
self-tapping, for fixing rebate
stay

Hole diameter 3.5 mm

PU = 50 pieces



451.093

Rahmendübel
für Beton/Ziegelvollstein/
Hochlochziegel, Torx-Angriff,
Länge 140 mm, Einbau mit
Torx-Klinge 499.005

VE = 50 Stück

451.093

Goujon d'ancrage
pour béton/briques pleines,
empreinte Torx, longueur
140 mm, fixation avec lame
Torx 499.005

UV = 50 pièces

451.093

Anchor bolt
for concrete/solid clay brick,
Torx-set recess head, length
140 mm, insert with Torx-set
blade 499.005

PU = 50 pieces



451.094

Rahmendübel
für Beton/Ziegelvollstein/
Hochlochziegel, Torx-Angriff,
Länge 160 mm, Einbau mit
Torx-Klinge 499.005

VE = 50 Stück

451.094

Goujon d'ancrage
pour béton/briques pleines,
empreinte Torx, longueur
160 mm, fixation avec lame
Torx 499.005



UV = 50 pièces

451.094

Anchor bolt
for concrete/solid clay brick,
Torx-set recess head, length
160 mm, insert with Torx-set
blade 499.005

PU = 50 pieces

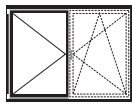
Übersicht Fensterbeschlag-Bohrlehren
 Sommaire gabarits de perçage pour ferrure de fenêtre
 Overview of drilling jigs for window fittings

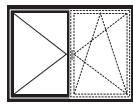
Artikel-Nummer Numéro d'article Part no.	Standard-Fensterbeschlag Ferrure de fenêtre Standard Standard window fitting			Verdeckt liegender Fensterbeschlag Ferrure de fenêtre non apparente Concealed window fitting	
					
499.450					
499.451 (1/2)					
499.451 (2/2)					
499.452 (1/2)					
499.452 (2/2)					
499.453 (1/2)					
499.453 (2/2)					
499.454 (1/3)					
499.454 (2/3)					
499.454 (3/3)					
499.455					
499.456					
499.457					
499.458					
499.459					
499.460					
499.461					
499.462					
499.463					
499.464					



499.298

Einspann-Unterlagen

aus Aluminium, Länge 325 mm, zum Sägen von Profil 30.900 auf Sägen mit horizontaler Spannvorrichtung

VE = 1 Paar

499.298

Supports

en aluminium, longueur 325 mm, pour couper les profilés 30.900 sur les machines munies d'un dispositif de serrage horizontal

UV = 1 pair

499.298

Cutting supports

aluminium, length 325 mm, for sawing section 630.900 on saws with horizontal clamp

PU = 1 pair



499.450

Bohrlehre Flügel

für die Getriebeausnehmung

VE = 1 Garnitur

Einsatz:
Standard- und verdeckt liegender Fensterbeschlag

499.450

Gabarit de perçage vantail

pour l'évidement du mécanisme

UV = 1 garniture

Utilisation:
Ferrure de fenêtre Standard et non apparente

499.450

Drilling jig for vent

for the cut-out on the mechanism case

PU = 1 set

Application:
Standard and concealed window fitting



499.451

Bohrlehre Flügel

für Getriebebeschienen

VE = 2 Stück

Einsatz:
Standard- und verdeckt liegender Fensterbeschlag

499.451

Gabarit de perçage vantail

pour crémonne de tringle

UV = 2 pièces

Utilisation:
Ferrure de fenêtre Standard et non apparente

499.451

Drilling jig for vent

for mechanism rod

PU = 2 pieces

Application:
Standard and concealed window fitting



499.452

Bohrlehre Flügel

für Stulpgetriebe

VE = 2 Stück

Einsatz:
Standard- und verdeckt liegender Fensterbeschlag

499.452

Gabarit de perçage vantail

pour Stulpgetriebe

UV = 2 pièces

Utilisation:
Ferrure de fenêtre Standard et non apparente

499.452

Drilling jig for vent

for Stulpgetriebe

PU = 2 pieces

Application:
Standard and concealed window fitting



499.453

Bohrlehre Flügel
für Mittenverriegelungen

VE = 2 Stück

Einsatz:
Standard- und verdeckt
liegender Fensterbeschlag

499.453

Gabarit de perçage vantail
pour verrouillages central

UV = 2 pièces

Utilisation:
Ferrure de fenêtre Standard
et non-apparente

499.453

Drilling jig for vent
for central locks

PU = 2 pieces

Application:
Standard and concealed
window fitting



499.454

Bohrlehre Flügel
für Oberschienen

VE = 3 Stück

Einsatz:
Standard- und verdeckt
liegender Fensterbeschlag

499.454

Gabarit de perçage vantail
pour tringle supérieure

UV = 3 pièces

Utilisation:
Ferrure de fenêtre Standard
et non apparente

499.454

Drilling jig for vent
for top rod

PU = 3 pieces

Application:
Standard and concealed
window fitting



499.455

Bohrlehre Rahmen
für Eck- und Scherenlager
sowie Kippband

VE = 1 Garnitur

Einsatz:
Standard-Fensterbeschlag

499.455

Gabarit de perçage cadre
pour charnière inférieure d'angle,
charnière supérieure du ciseaux
et paumelle soufflet

UV = 1 garniture

Utilisation:
Ferrure de fenêtre Standard

499.455

Drilling jig for frame
for corner hinge, scissor
hinge and tilt hinge

PU = 1 set

Application:
Standard window fitting



499.456

Bohrlehre Flügel
für Eckumlenkung und
Flügellager

VE = 1 Stück

Einsatz:
Standard- und verdeckt
liegender Fensterbeschlag

499.456

Gabarit de perçage vantail
pour fiche d'angle du vantail
et renvoi d'angle

UV = 1 pièce

Utilisation:
Ferrure de fenêtre Standard
et non apparente

499.456

Drilling jig for vent
for leaf hinge and
corner guides

PU = 1 piece

Application:
Standard and concealed
window fitting



499.457

Bohrlehre Flügel
für Drehlager

VE = 1 Stück

Einsatz:
Standard-Fensterbeschlag

499.457

Gabarit de perçage vantail
pour charnière

UV = 1 pièce

Utilisation:
Ferrure de fenêtre Standard

499.457

Drilling jig for vent
for pivot hinge

PU = 1 piece

Application:
Standard window fitting



499.458

Bohrlehre Flügel
für Kippband, Zwangs-
verriegelung und
Schnäpperbolzen

VE = 1 Stück

Einsatz:
Standard- und verdeckt
liegender Fensterbeschlag

499.458

Gabarit de perçage vantail
pour charnière de soufflet,
verrouillage forcé et goujon
d'encliquetage

UV = 1 pièce

Utilisation:
Ferrure de fenêtre Standard
et non apparente

499.458

Drilling jig for vent
for bottom-hung hinge,
forced locking and bolt for
spring-loaded catch

PU = 1 piece

Application:
Standard and concealed
window fitting

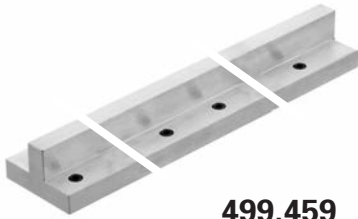

499.459

Bohrlehre Rahmen
für Schliessblech und
Kippschliessblech

VE = 1 Stück

Einsatz:
Standard- und verdeckt
liegender Fensterbeschlag

499.459

Gabarit de perçage cadre
pour gâche du rouleau et
gâche oscillo-battant

UV = 1 pièce

Utilisation:
Ferrure de fenêtre Standard
et non apparente

499.459

Drilling jig frame
for strike plate and
tilt striking plate

PU = 1 piece

Application:
Standard and concealed
window fitting



499.460

Bohrlehre Rahmen
für Ecklager, Rahmenanbindung
und Adapterplatte

VE = 1 Stück

Einsatz:
Verdeckt liegender
Fensterbeschlag

499.460

Gabarit de perçage cadre
pour charnière d'angle,
raccordement au cadre et
profilés d'adaptation

UV = 1 pièce

Utilisation:
Ferrure de fenêtre
non apparente

499.460

Drilling jig for frame
for corner pivot, frame
attachment and adapter profiles

PU = 1 piece

Application:
Concealed window fitting



499.461

Bohrlehre Rahmen
für Schere und Drehlager

VE = 1 Stück

Einsatz:
Verdeckt liegender
Fensterbeschlag

499.461

Gabarit de perçage cadre
pour compas et pivot

UV = 1 pièce

Utilisation:
Ferrure de fenêtre
non apparente

499.461

Drilling jig for frame
for stay and pivots

PU = 1 piece

Application:
Concealed window fitting

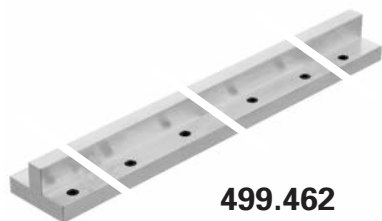

499.462

Bohrlehre Rahmen
für Balkonschnäpper und
Zwangsverriegelungen

VE = 1 Stück

Einsatz:
Standard- und verdeckt
liegender Fensterbeschlag

499.462

Gabarit de perçage cadre
pour loqueteaux pour portes de
balcon et verrouillages forcés

UV = 1 pièce

Utilisation:
Ferrure de fenêtre Standard
et non apparente

499.462

Drilling jig for frame
for balcony door catch and
forced locking points

PU = 1 piece

Application:
Standard and concealed
window fitting



499.463

Bohrlehre Flügel
für Flügellager und
Drehbegrenzer

VE = 1 Stück

Einsatz:
Verdeckt liegender
Fensterbeschlag

499.463

Gabarit de perçage vantail
pour fiche d'angle du vantail
et compas de limitation
d'ouverture

UV = 1 pièce

Utilisation:
Ferrure de fenêtre
non apparente

499.463

Drilling jig for vent
for leaf hinge part and
opening limiter

PU = 1 piece

Application:
Concealed window fitting



499.464

Bohrlehre Flügel
für Drehlagerschiene

VE = 1 Stück

Einsatz:
Verdeckt liegender
Fensterbeschlag

499.464

Gabarit de perçage vantail
pour crémonne de compas

UV = 1 pièce

Utilisation:
Ferrure de fenêtre
non apparente

499.464

Drilling jig for vent
for pivot hinge rod

PU = 1 piece

Application:
Concealed window fitting



499.380

Bohrlehrensatz
für Oberlichtöffner F200

VE = 1 Garnitur

499.380

Jeu de gabarit de perçage
pour ferrure d'imposte F200

UV = 1 garniture

499.380

Set of drilling jigs
for top light opener F200

PU = 1 set



499.319

Bohrlehre
für Entwässerungstülle
450.047/450.049

VE = 1 Stück

499.319

Gabarit de perçage
pour douille d'évacuation
d'eau 450.047/450.049

UV = 1 pièce

499.319

Drilling jig
for draining pipe
450.047/450.049

PU = 1 piece



499.312

Stufenbohrer
ø 6,7 x 12 mm,
für Entwässerungstülle
450.047/450.049

VE = 1 Stück

499.312

Mèche étagée HSS
ø 6,7 x 12 mm, pour douille
d'évacuation d'eau
450.047/450.049

UV = 1 pièce

499.312

Stepped drill
ø 6,7 x 12 mm,
for draining pipe
450.047/450.049

PU = 1 piece



499.339

Kegelsenker
15 x 100 mm, zum Ansenken
der Bohrungen für die
Entwässerungstülle
450.047/450.049

VE = 1 Stück

499.339

Fraise conique
15 x 100 mm, pour faire le
chanfrein des trous pour les
douille d'évacuation d'eau
450.047/450.049

UV = 1 pièce

499.339

Countersink
15 x 100 mm, for countersinking
the drill holes for draining pipe
450.047/450.049

PU = 1 piece



499.318

Montagewerkzeug
für den Einbau der
Entwässerungstülle
450.047/450.049

VE = 1 Stück

499.318

Outil de montage
pour la montage de la douille
d'évacuation d'eau
450.047/450.049

UV = 1 pièce

499.318

Fitting tool
for installation of draining
pipe 450.047/450.049

PU = 1 piece



499.102

Montagehebel
zum Ausrichten der
Befestigungsfedern 450.022

VE = 1 Stück

499.102

Lever de montage
pour ajuster les ressorts de
fixation 450.022

UV = 1 pièce

499.102

Assembly lever
for straightening fixing
springs 450.022

PU = 1 piece

Verarbeitungshilfen**Outils d'usinage****Assembly tools**

Jansen-Economy 50 Fenster

Jansen-Economy 50 fenêtres

Jansen-Economy 50 windows

**499.108****Dichtungsroller**

zum Einrollen von verschiedenen Jansen-Dichtungen

VE = 1 Stück

499.108**Roulette à joint**

pour monter des joints divers Jansen

UV = 1 pièce

499.108**Gasket roller**

for inserting various Jansen gaskets

PU = 1 piece

**499.425****Dichtungsschere**

für den Zuschnitt der Dichtungen

VE = 1 Stück

499.425**Ciseau à joint**

pour la découpe des joints

UV = 1 pièce

499.425**Weatherstrip shear**

for cutting the weatherstrips

PU = 1 piece

**499.261****Kupfer-Schweisslehre**

für die Wärmeabtragung beim Schweißen der Edelstahlprofile

VE = 2 Stück

499.261**Gabarit de soudage**

en cuivre pour l'évacuation de la chaleur lors du soudage des profilés acier Inox

UV = 2 pièces

499.261**Copper welding template**

for heat dissipation of stainless steel profiles during welding

PU = 2 pieces



499.001

Befestigungsset

zum Versetzen der magazinierten
Befestigungs-Knöpfe 450.007/008

VE = 1 Set komplett inkl. Koffer
3 Kreuzschlitz-
Schraubklingen

499.001

**Machine à poser les boutons
de parcloses**

pour le déplacement des
boutons de fixations 450.007/008
emmagasinés

UV = 1 set complet, valise incl.
3 mèches cruciforme

499.001

Fastening set

for placing magazine fixing
studs 450.007/008

PU = 1 set complete, incl. case
3 Phillips screwdriver
blades



499.002

Kreuzschlitz-Schraubklingen
für Befestigungsset 499.001

VE = 3 Stück

499.002

**Embout de tournevis
cruciforme**

pour machine à poser 499.001

UV = 3 pièces

499.002

**Blades for cross-recessed
screws (Phillips)**

for fastening set 499.001

PU = 3 pieces



499.004

Spiralbohrer ø 3,5 mm
mit Sechskantschaft zum Bohren
der Löcher für 450.006

VE = 3 Spiralbohrer
1 Kupplungsüber-
brückung für Set 499.001

499.004

Mèche hélicoïdale ø 3,5 mm
avec serrage 6-pans pour percer
les trous de 450.006

UV = 3 mèches hélicoïdales
1 système d'embrayage
pour set 499.001

499.004

Twist drill ø 3,5 mm
with hexagonal shaft, for drilling
holes for 450.006

PU = 3 twist drills
1 coupling bridge for
Set 499.001



499.039

Bohrer-Führung ø 3,5 mm
für Befestigungsset 499.001,
optimiert die Führung des
Spiralbohrers 499.004 und
ermöglicht ein genaues Bohren.

VE = 1 Stück

499.039

Guidage de foret ø 3,5 mm
pour la machine à poser les bou-
tons 499.001, optimise le guidage
de la mèche hélicoïdale 499.004
et permet un perçage précis.

UV = 1 pièce

499.039

Drill guide ø 3,5 mm
for fastening set 499.001,
optimises the guidance of the
twist drill 499.004, and permits
precise drilling.

PU = 1 piece



499.003

Schraubklingen
mit SR1-Angriff,
für Akku-Schrauber

VE = 3 Stück

499.003

Embout de tournevis
avec tête spéciale SR1,
pour visseuse à accumulateur

UV = 3 pièces

499.003

Blades
with SR1 head, for battery-
operated srew driver

PU = 3 pieces

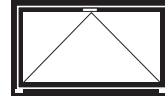
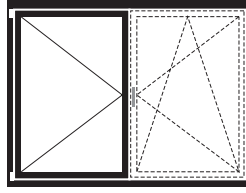
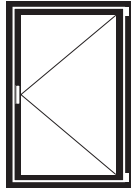
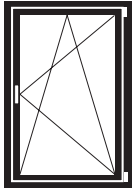

Standard-Fensterbeschlag

Ferrure de fenêtre Standard

Standard window fitting

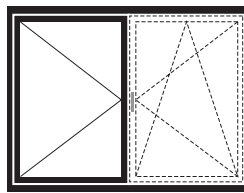
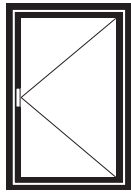
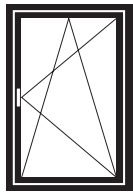

Verdeckt liegender Fensterbeschlag

Ferrure de fenêtre non apparente

Concealed window fitting

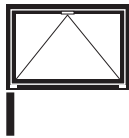
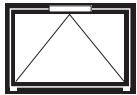

Oberlichtöffner

Ferrure d'imposte

Top light opener

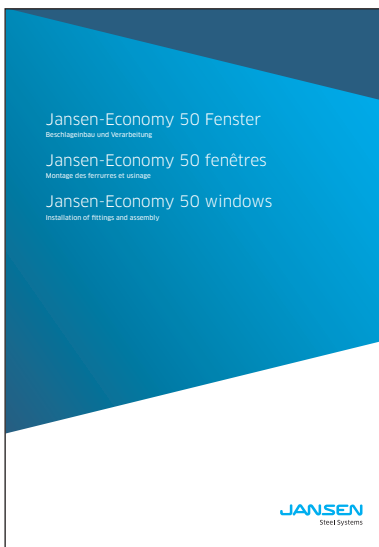

Beschlageinbau-Zeichnungen für den Standard-Fensterbeschlag sowie den verdeckt liegenden Fensterbeschlag siehe «Jansen-Economy 50 Fenster – Beschlageinbau und Verarbeitung»

Dessins de montage des ferrures standard pour fenêtre ainsi que la ferrure de fenêtre non apparente voir «Jansen-Economy 50 fenêtres – Montage des ferrures et usinage»

Drawings for installation of fittings of the standard window fitting and the concealed window fitting see «Jansen-Economy 50 windows – Installation of fittings and assembly».

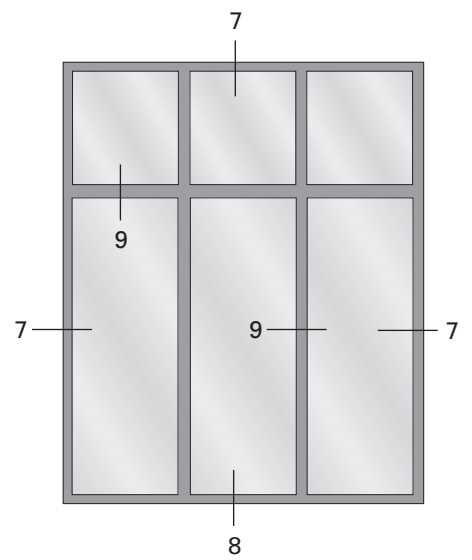
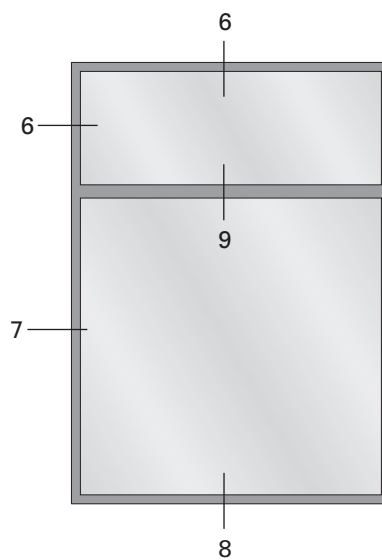
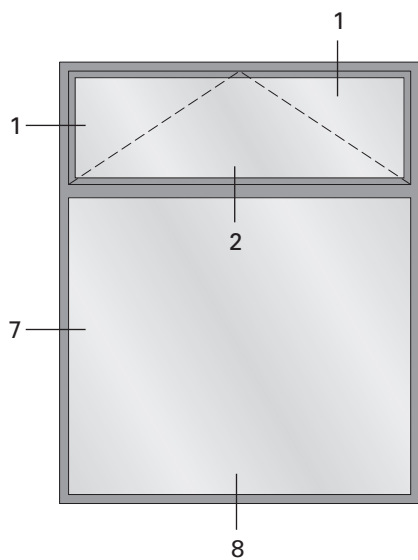
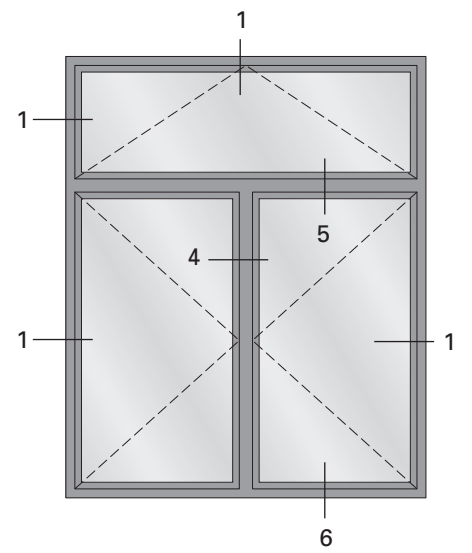
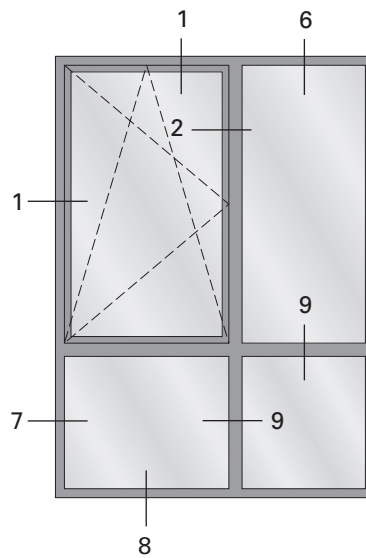
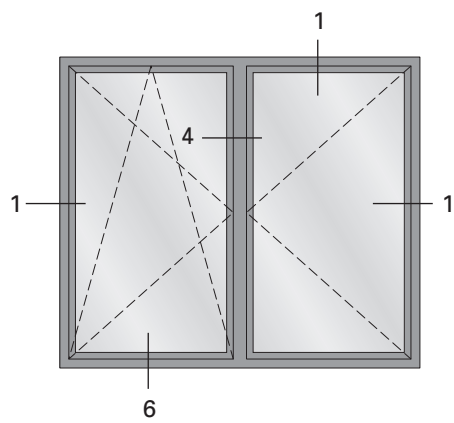
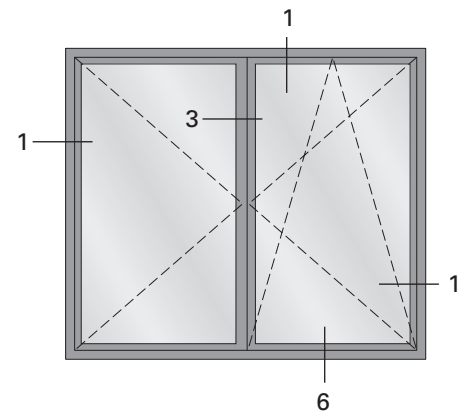
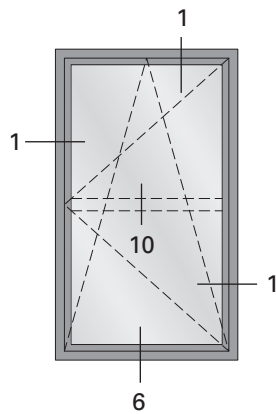
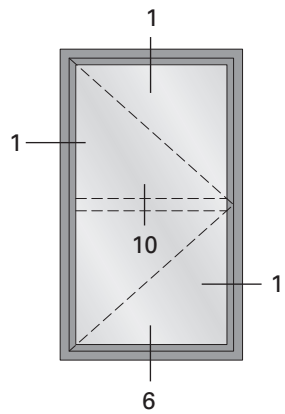

1.0

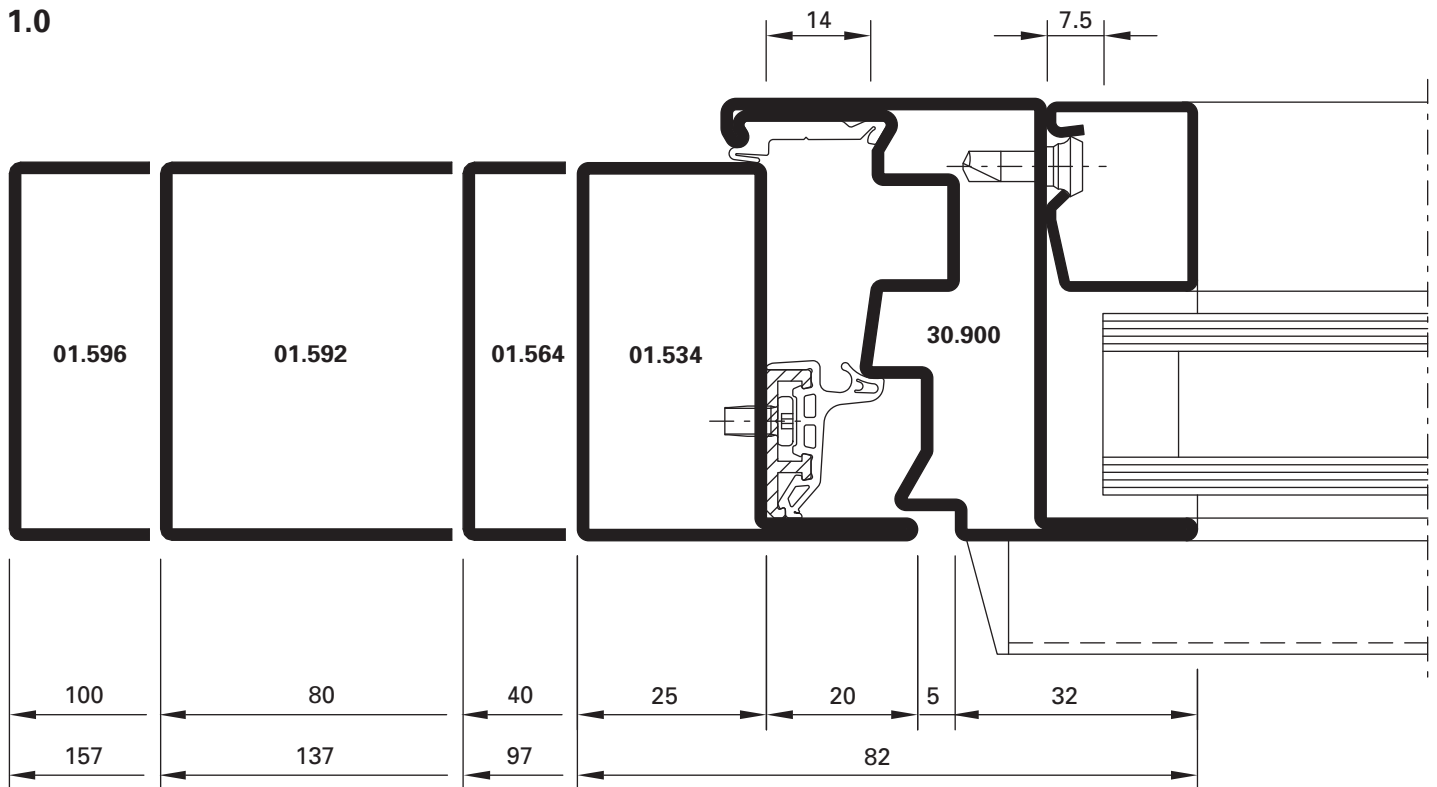

DXF DWG D-201-C-001

3.0

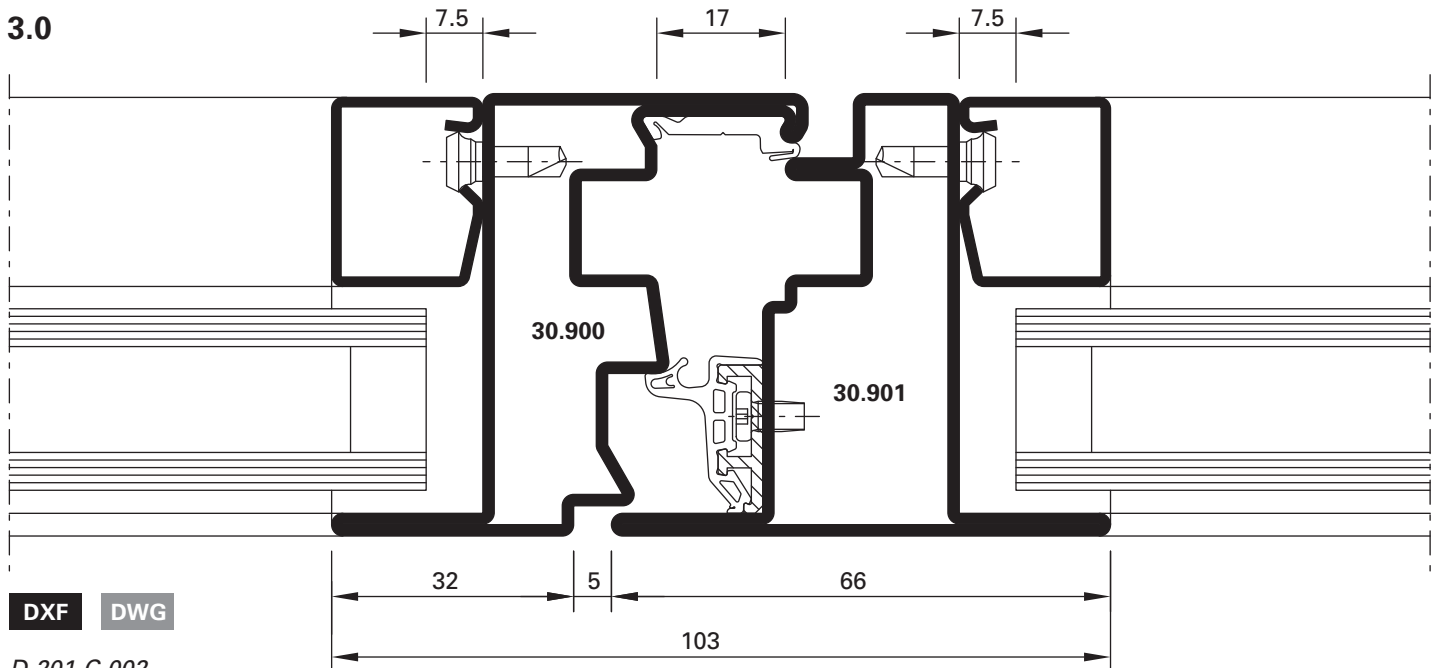

DXF DWG

D-201-C-002

2.0

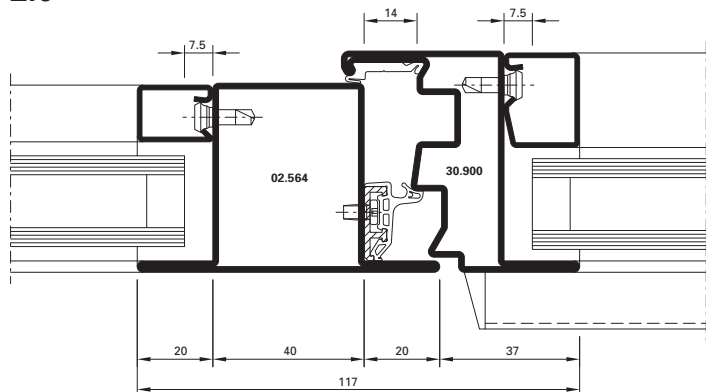

DXF **DWG** *D-201-C-003*

4.0

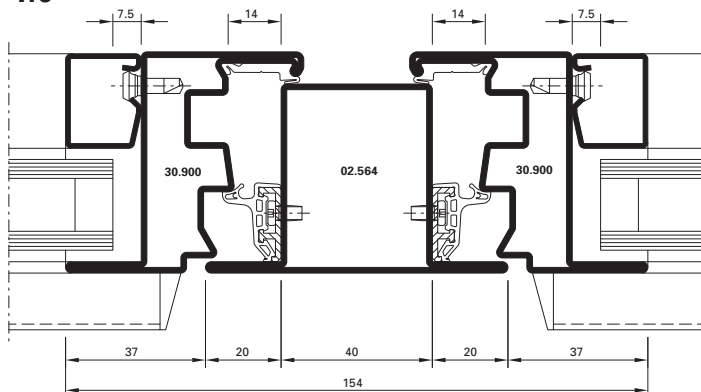

DXF **DWG** *D-201-C-004*

2.1

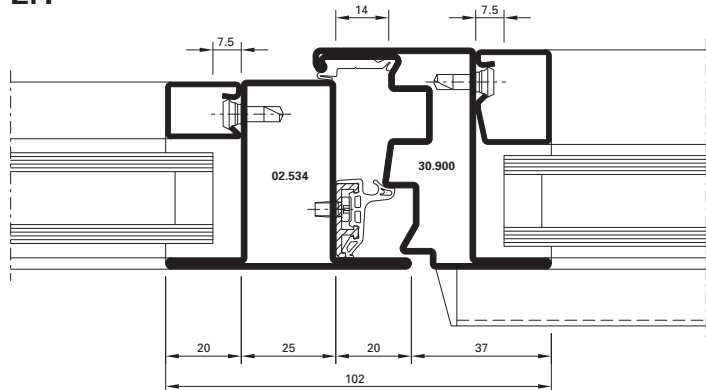

DXF **DWG** *D-201-C-005*

4.1

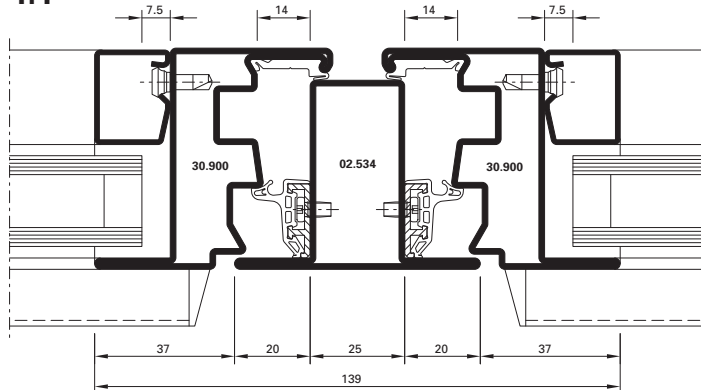

DXF **DWG** *D-201-C-006*

7.0

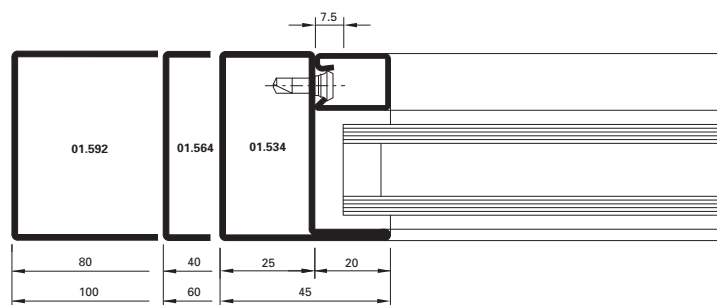

DXF **DWG** *D-200-C-001*

7.1

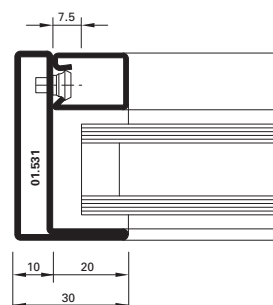

DXF **DWG** *D-201-C-013*

7.2

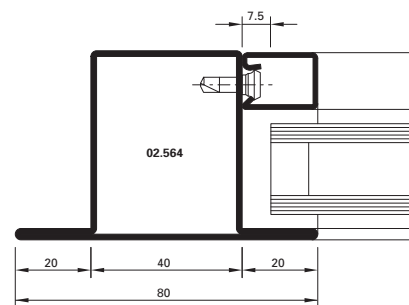

DXF **DWG** *D-201-C-049*

U_f-Werte siehe Seite 138

Valeurs U_f voir page 138

U_f values see page 138

9.0

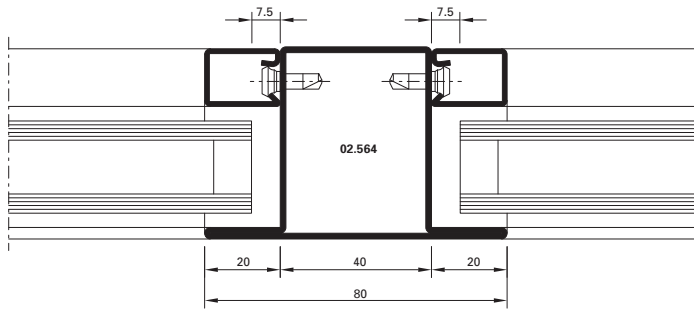

DXF **DWG** *D-200-C-016*

9.1

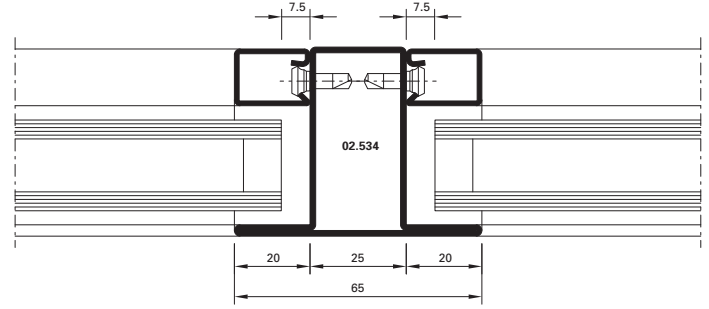

DXF **DWG** *D-200-C-046*

9.2

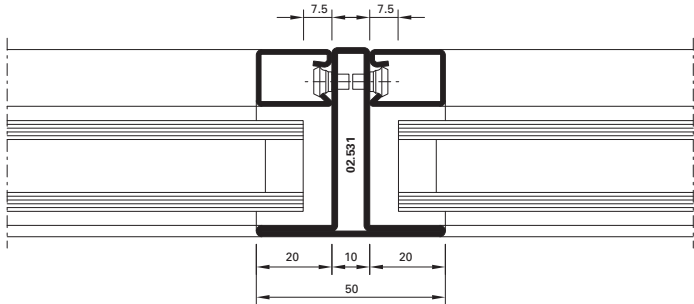

DXF **DWG** *D-200-C-018*

9.3

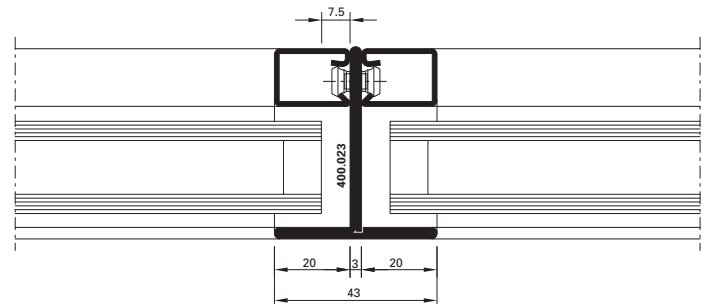

DXF **DWG** *D-200-C-019*

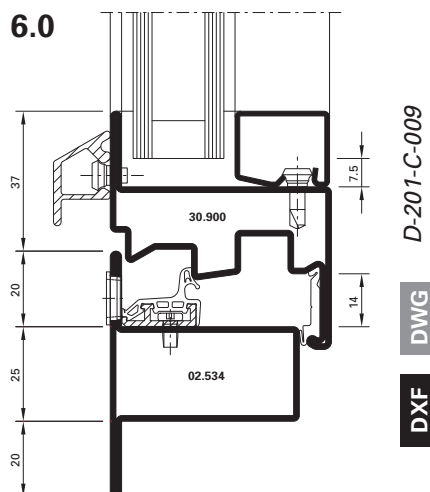
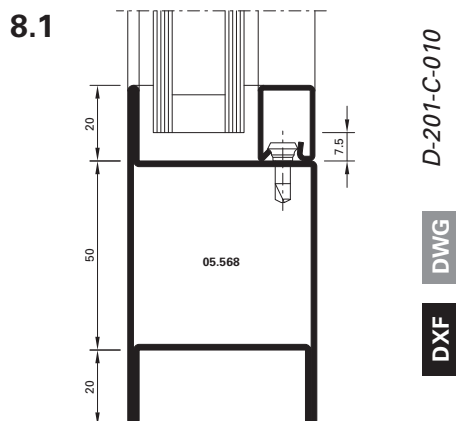
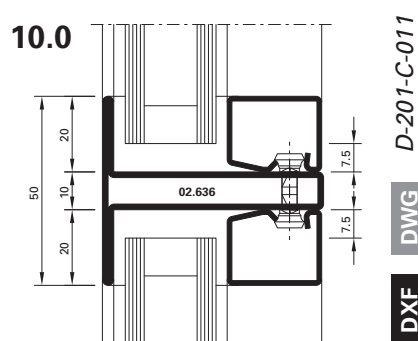
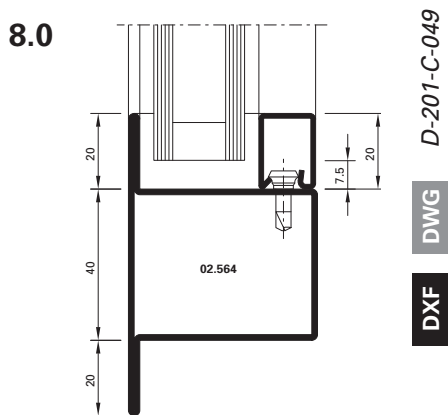
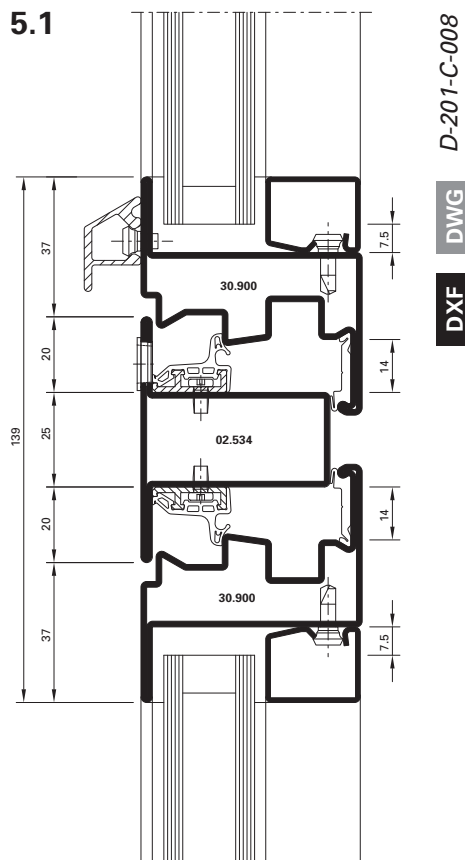
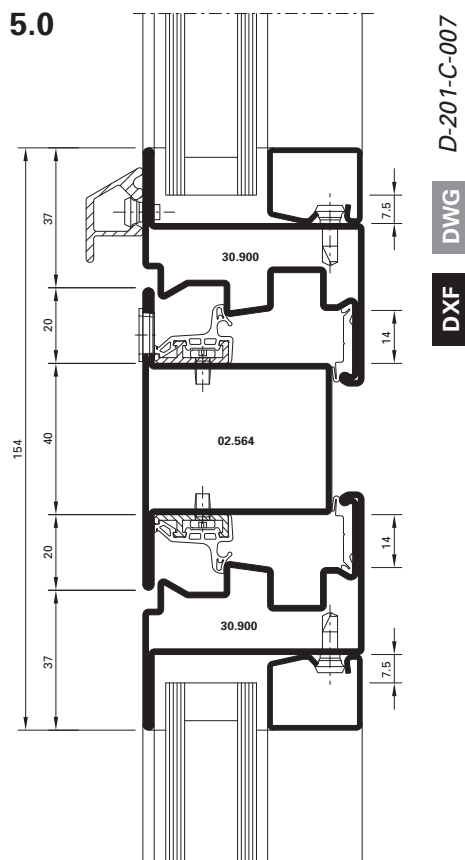

C-C

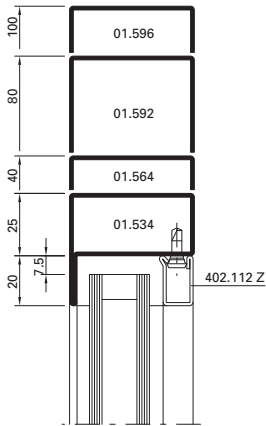

E-E

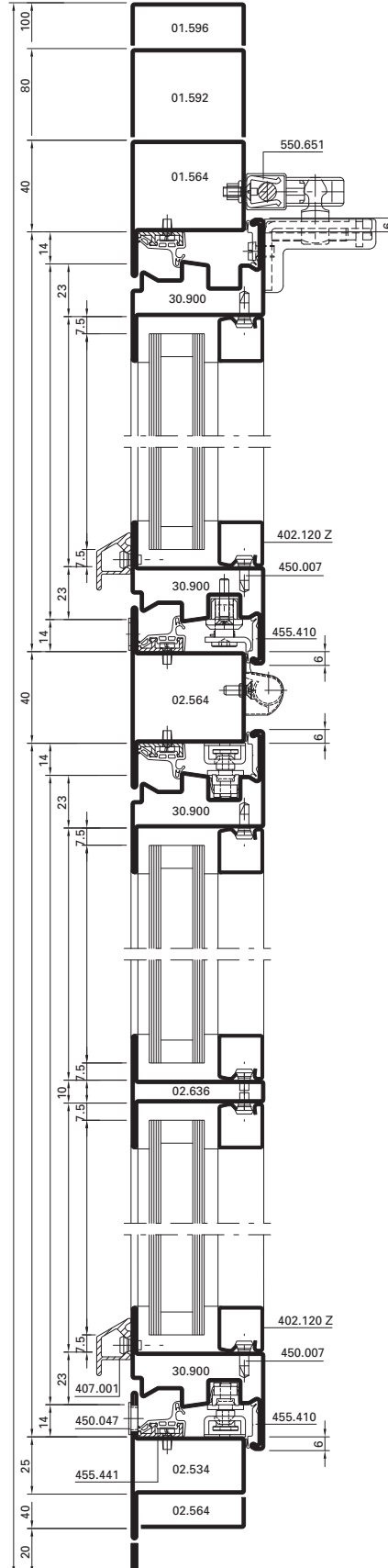

B-B

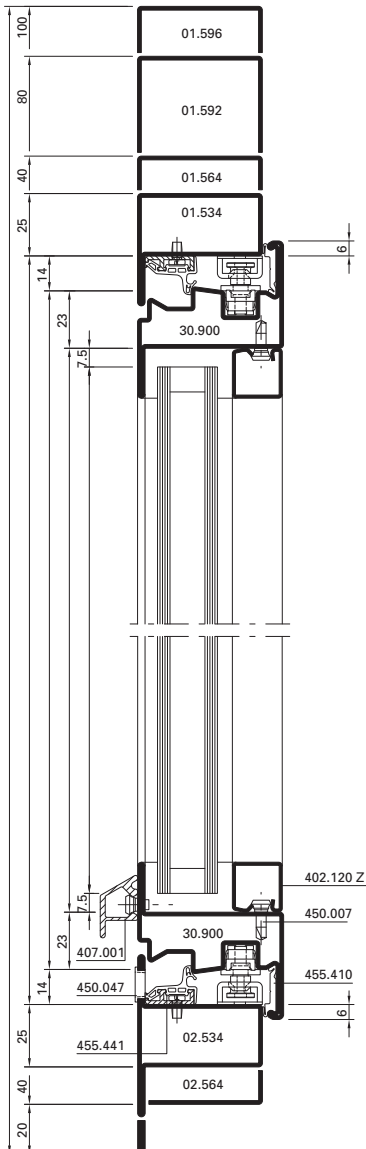

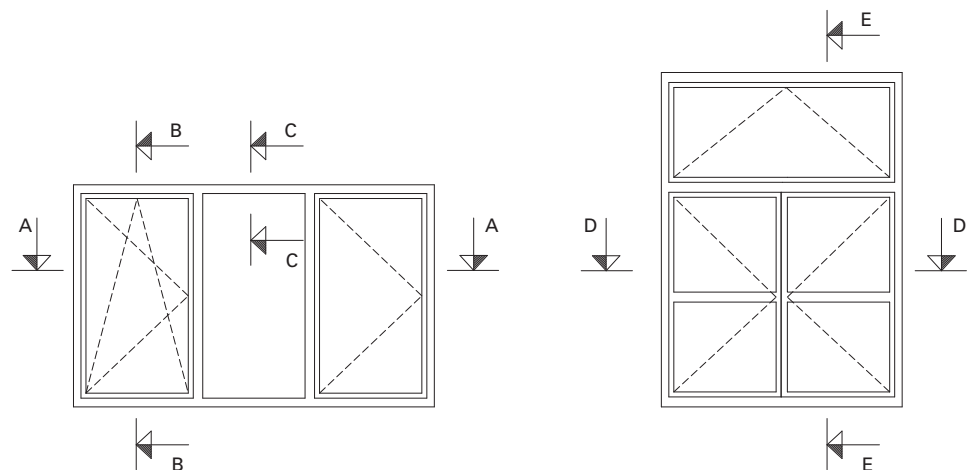
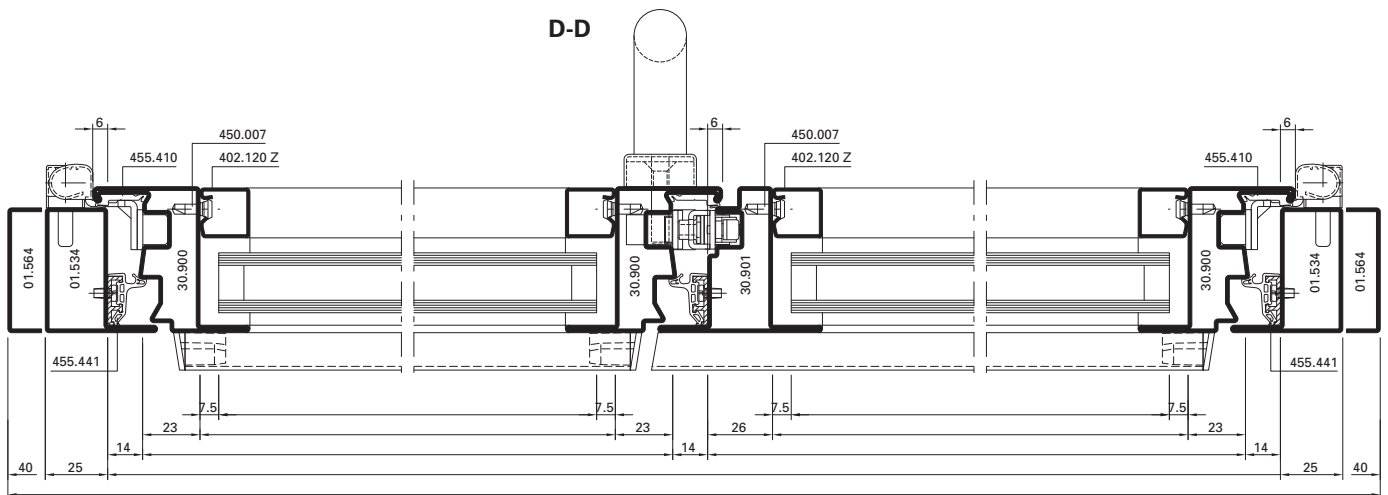
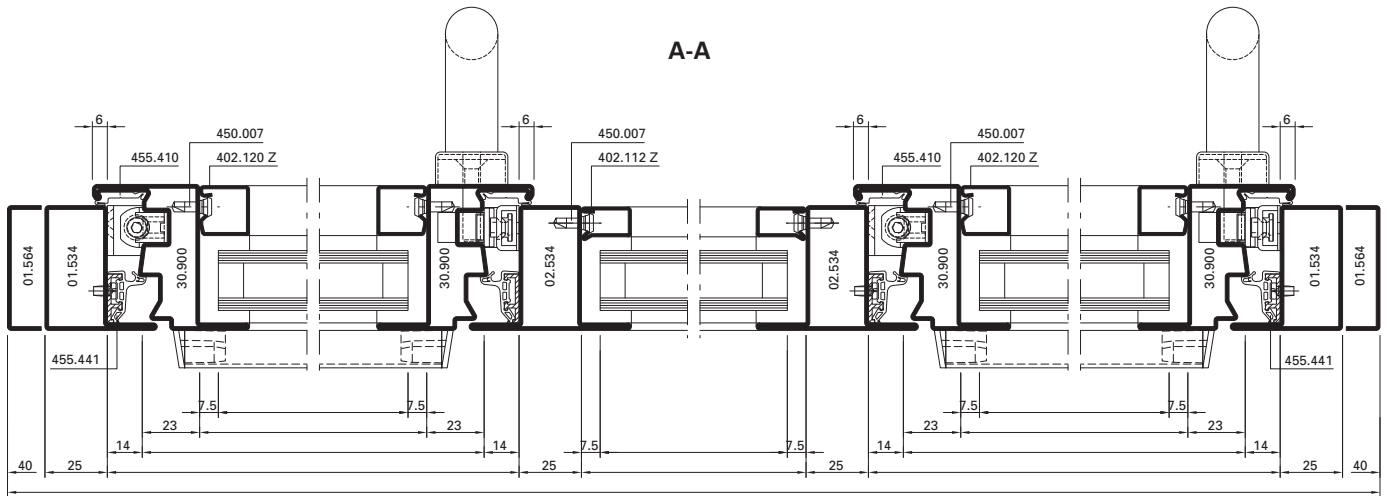

C-C

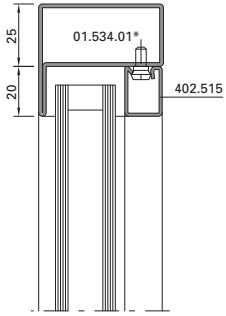

E-E

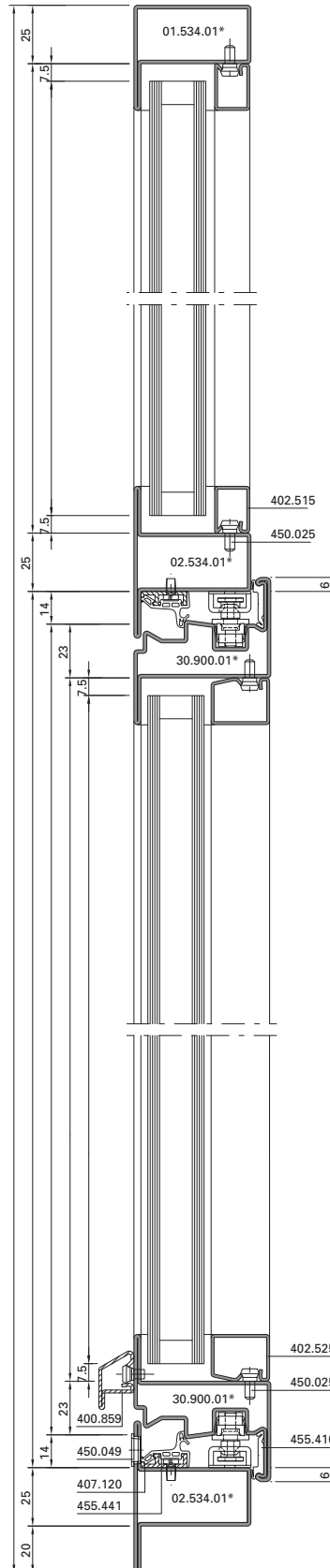

B-B

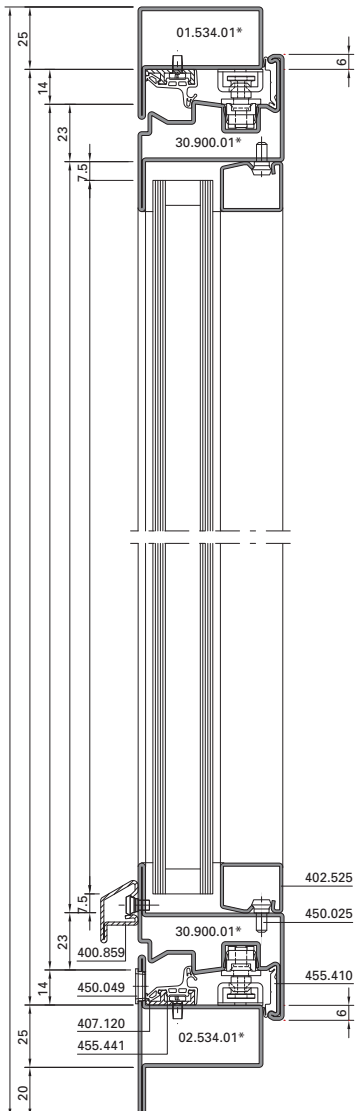

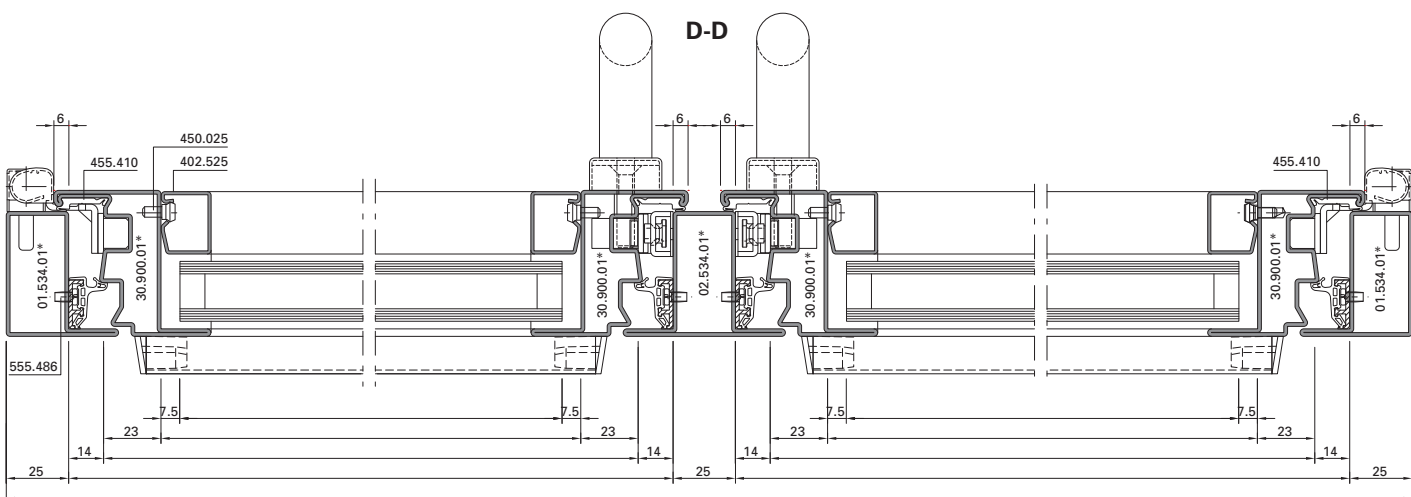
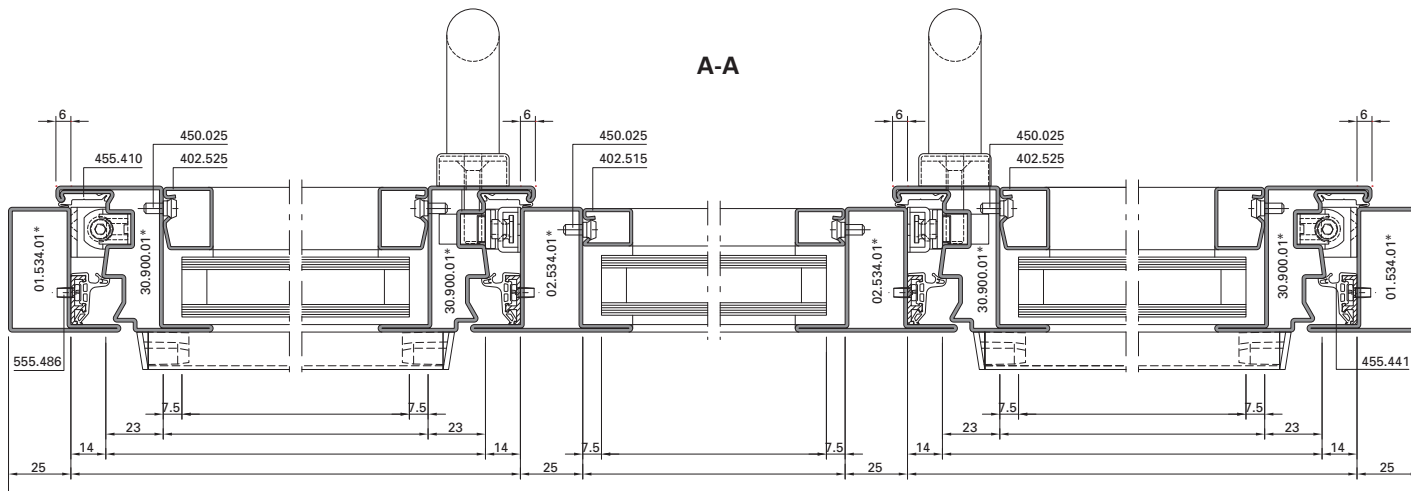

* Edelstahl-Ausführung
 siehe Seite 16

* Version en acier inox,
 voir la page 16

* For the stainless steel design,
 see page 16

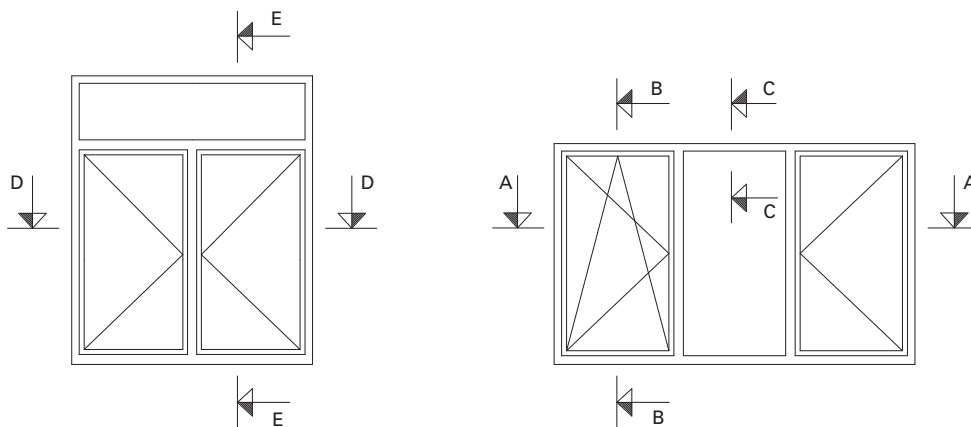

Glasleisten-Varianten im Massstab 1:2

Variantes de parcloses à l'échelle 1:2

Glazing bead options on scale 1:2

Jansen-Economy 50 Fenster

Jansen-Economy 50 fenêtres

Jansen-Economy 50 windows

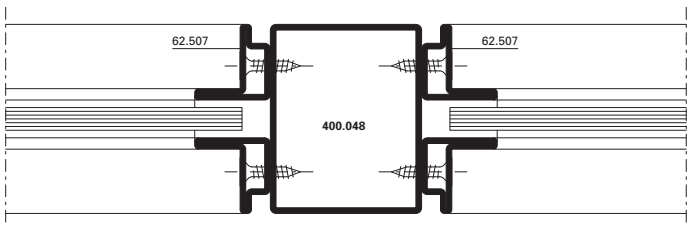
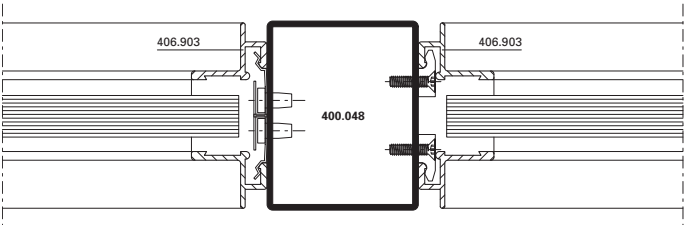
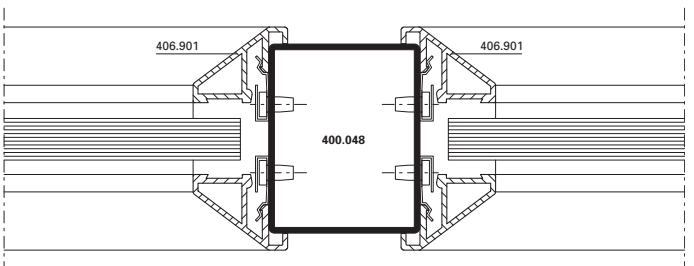
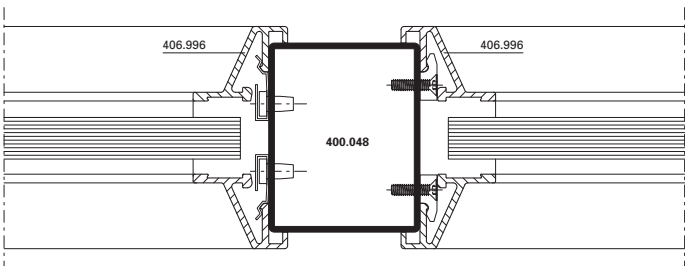
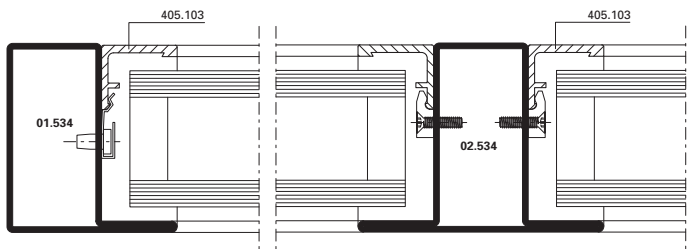
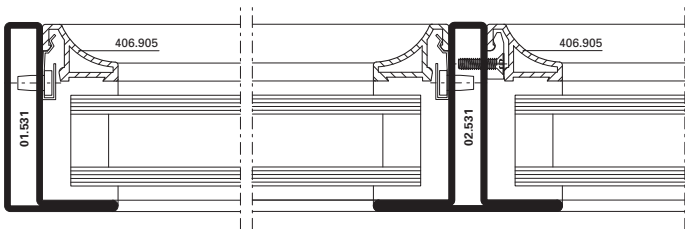
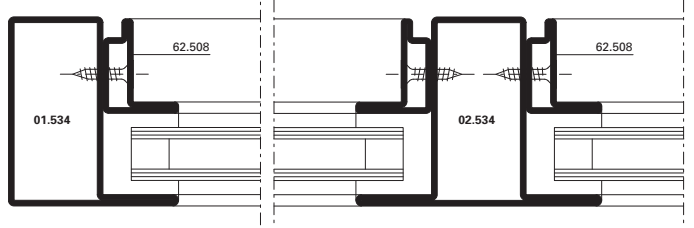
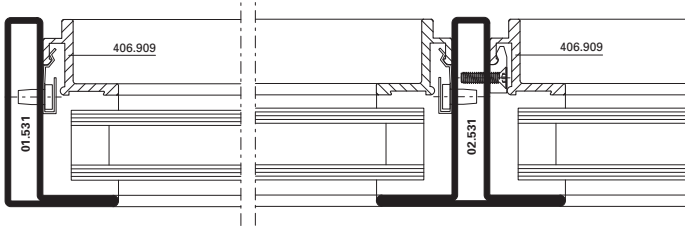

Platzbedarf
 Standard-Fensterbeschlag

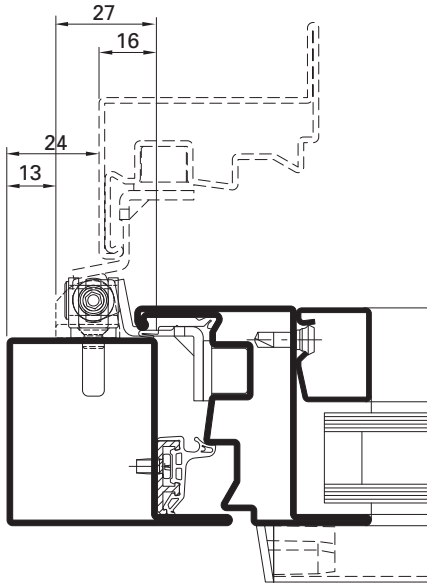

Espace nécessaire
 Ferrure de fenêtre standard

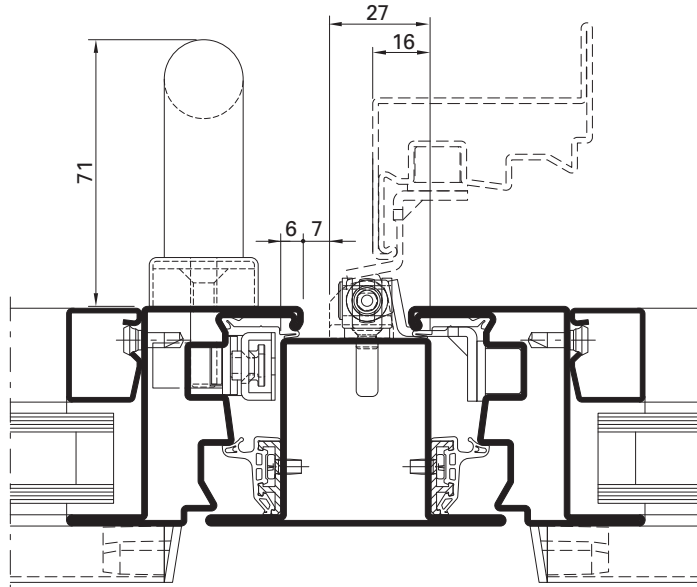

Space required
 Standard window fitting

Platzbedarf
 Verdeckt liegender Fensterbeschlag

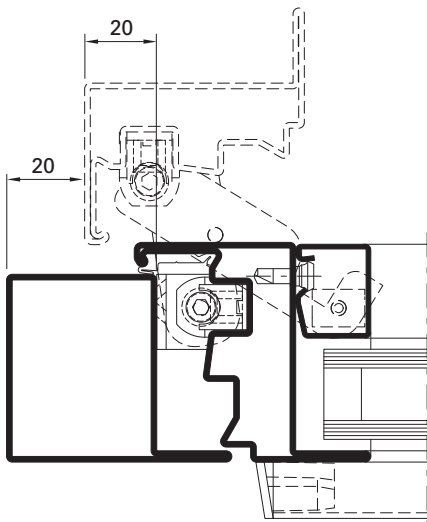

Espace nécessaire
 Ferrure de fenêtre non apparente

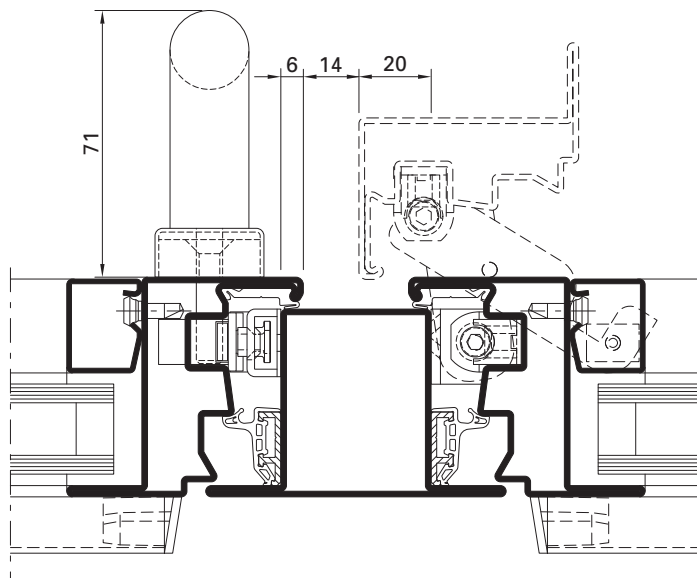

Space required
 Concealed window fitting

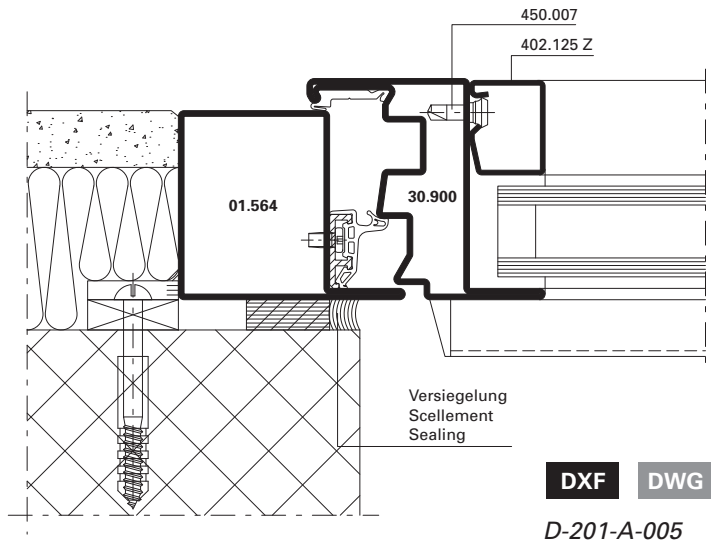
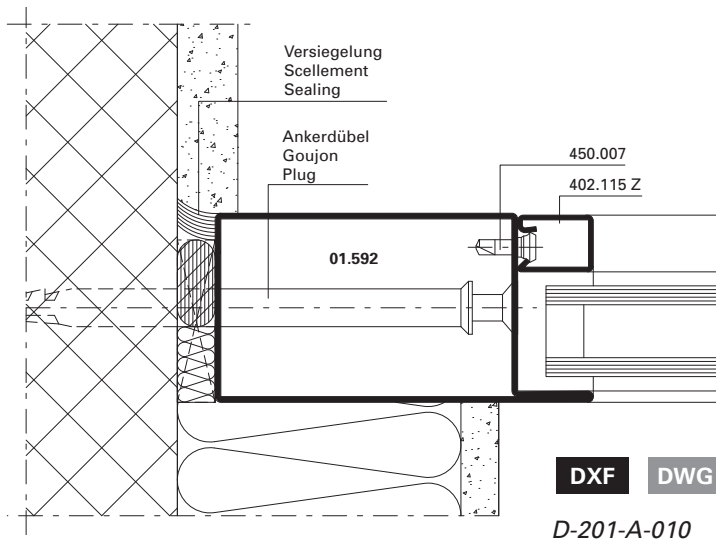
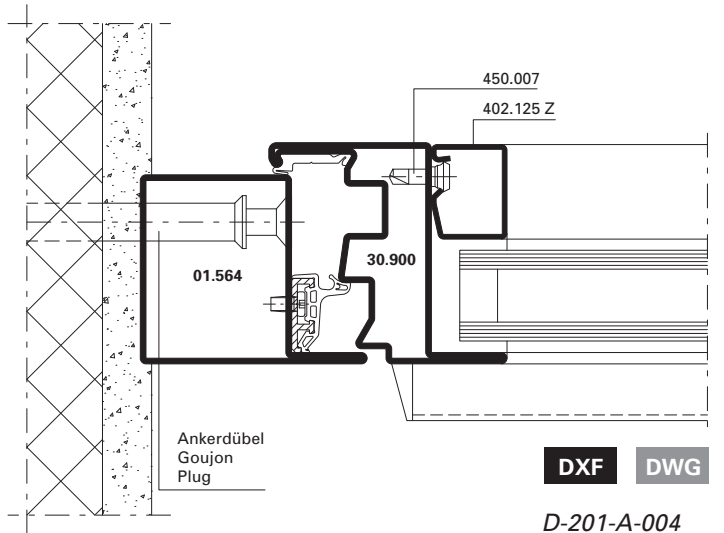
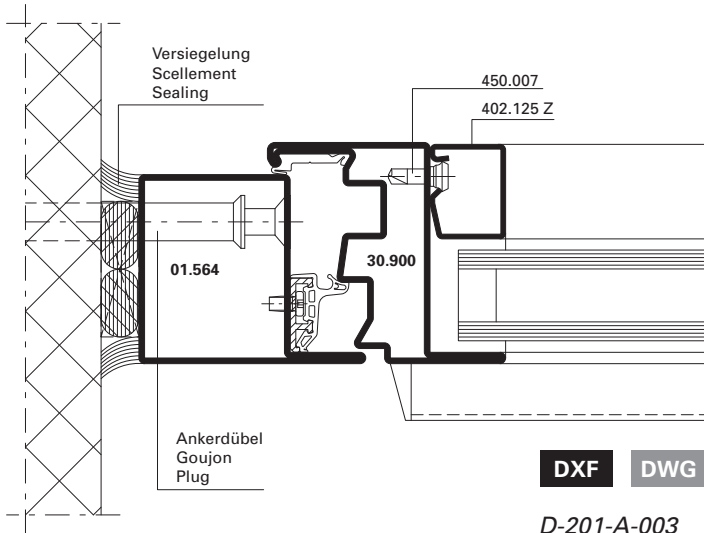
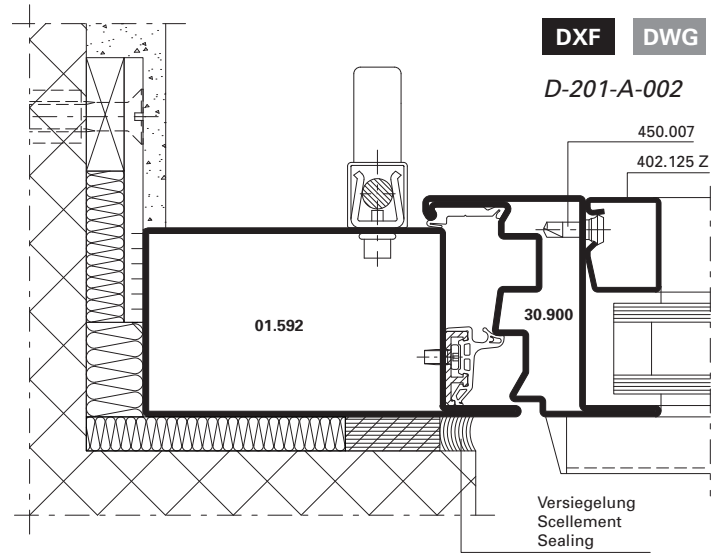
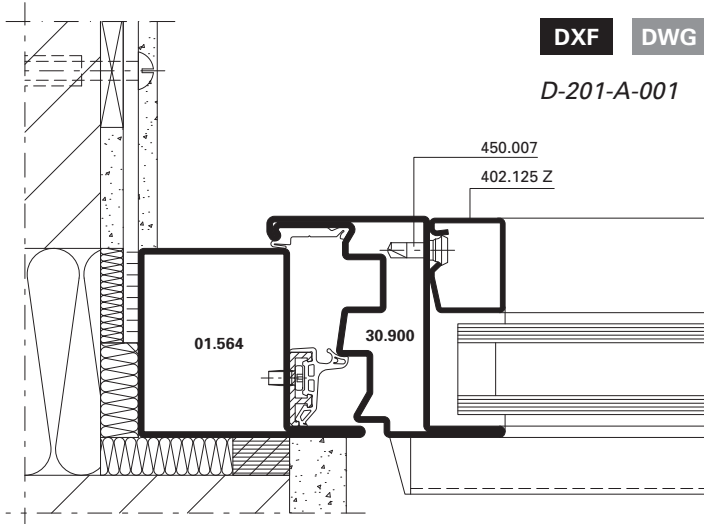

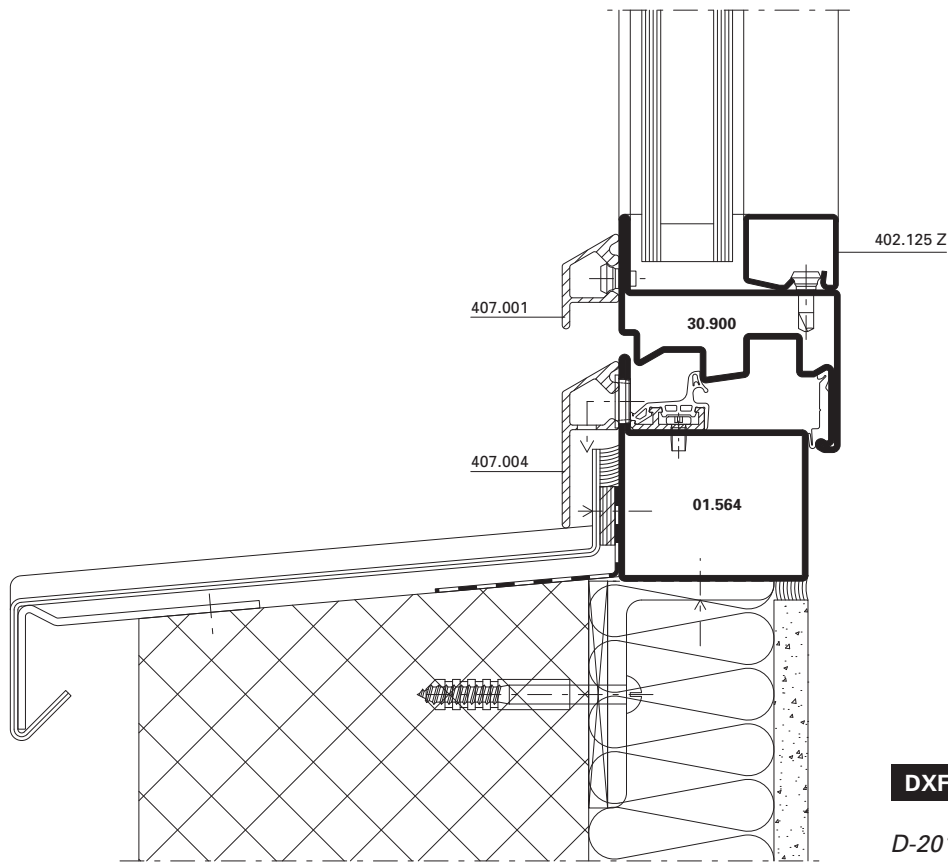

DXF DWG

D-201-A-006

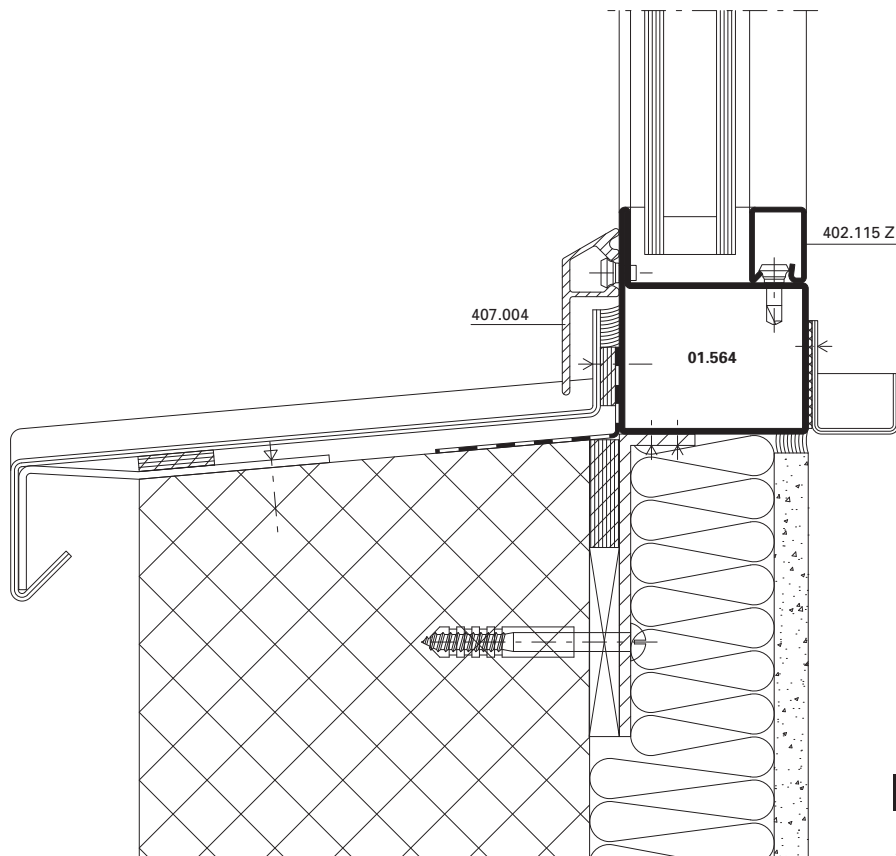

DXF DWG

D-201-A-007

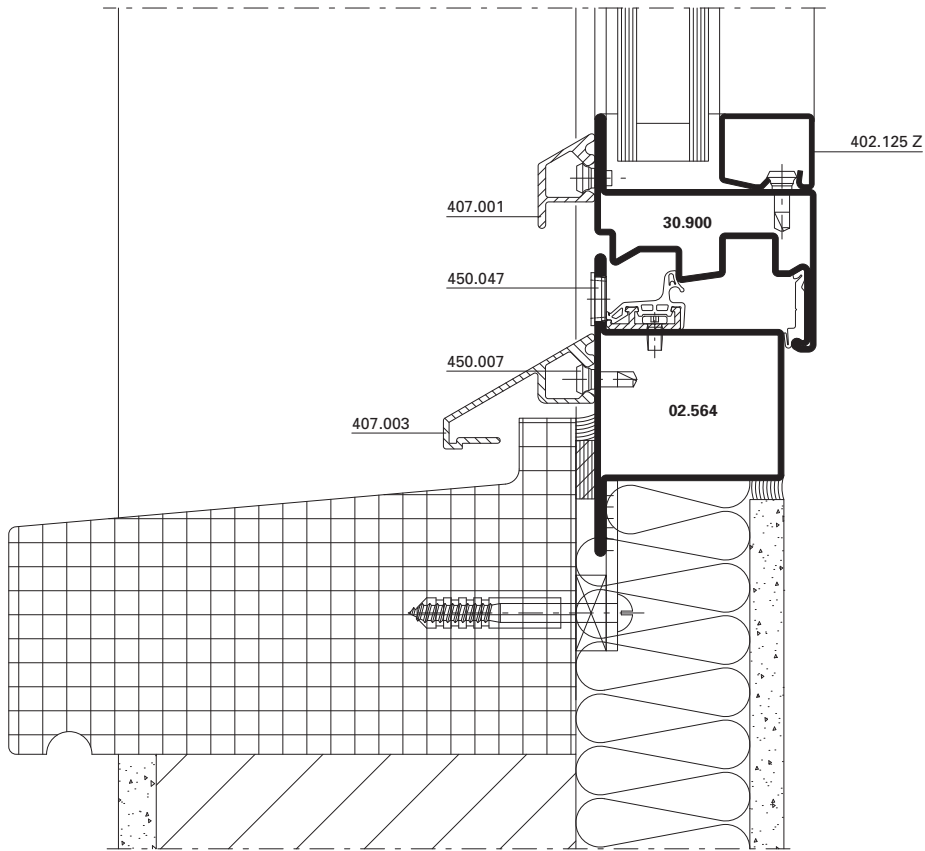

DXF DWG

D-201-A-008

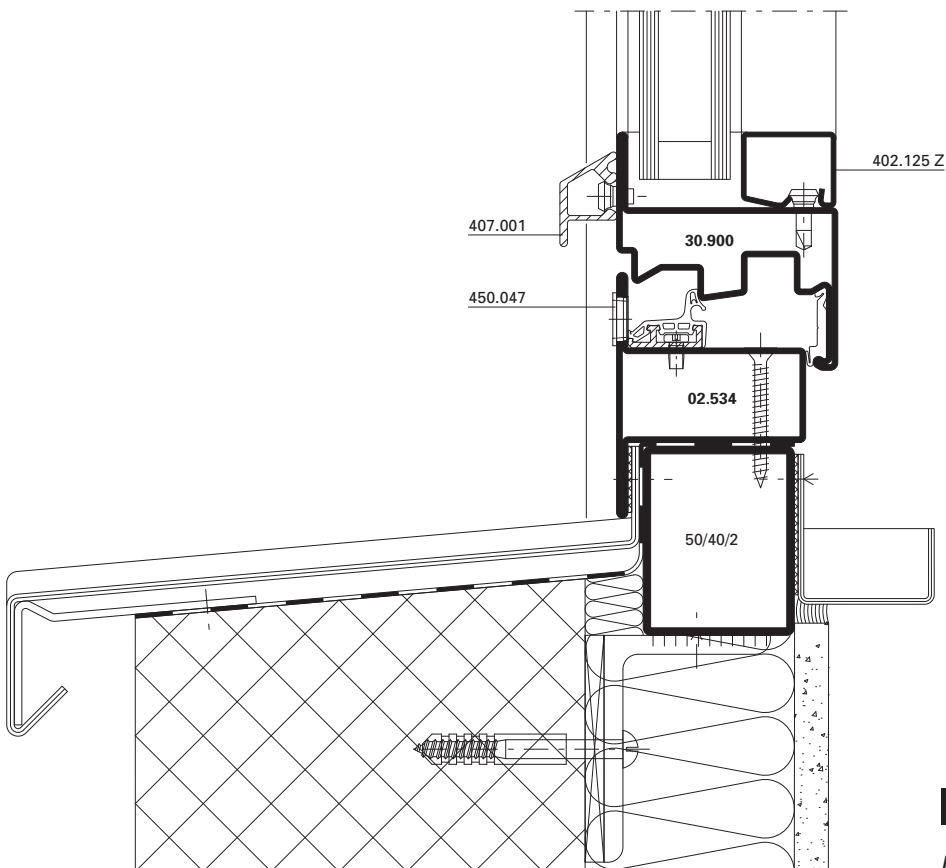

DXF DWG

D-201-A-009

Inhaltsverzeichnis	Sommaire	Content	
Massbezeichnungen	Dimensions cotées	Measurement descriptions	136
U _f -Werte	Valeurs U _f	U _f values	138
Leistungswerte Fenster aus Stahl und Edelstahl	Caractéristiques de performances Fenêtres en acier et acier Inox	Performance values windows made of steel and stainless steel	143
CE Kennzeichnung	Marquage CE	CE marking	144

Massbezeichnungen

Dimensions cotées

Measurement descriptions

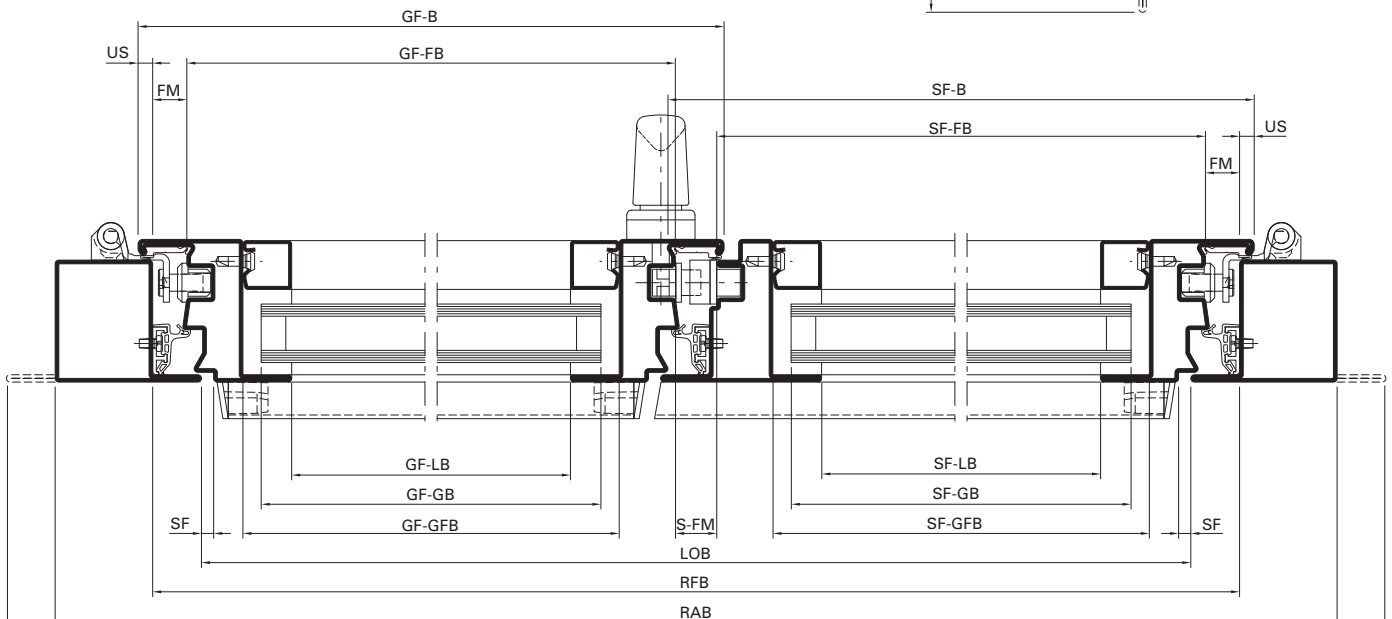
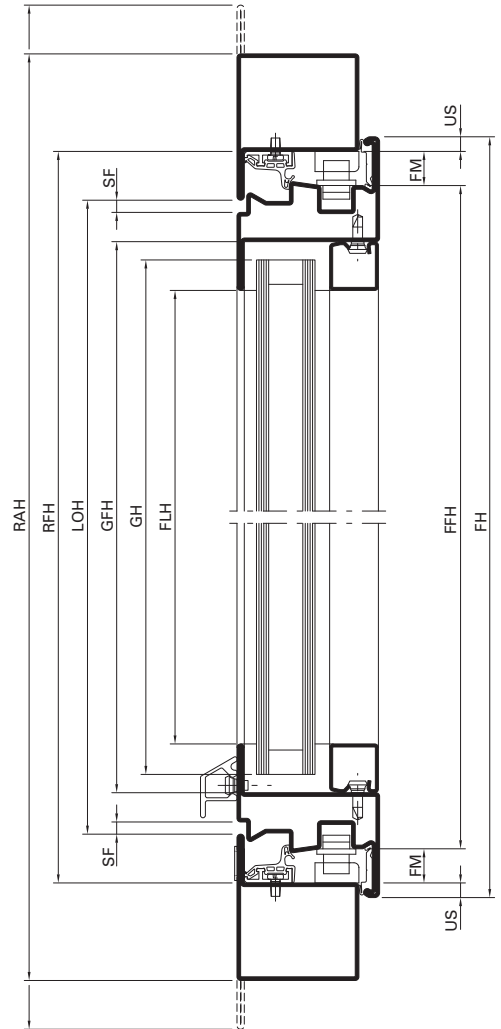
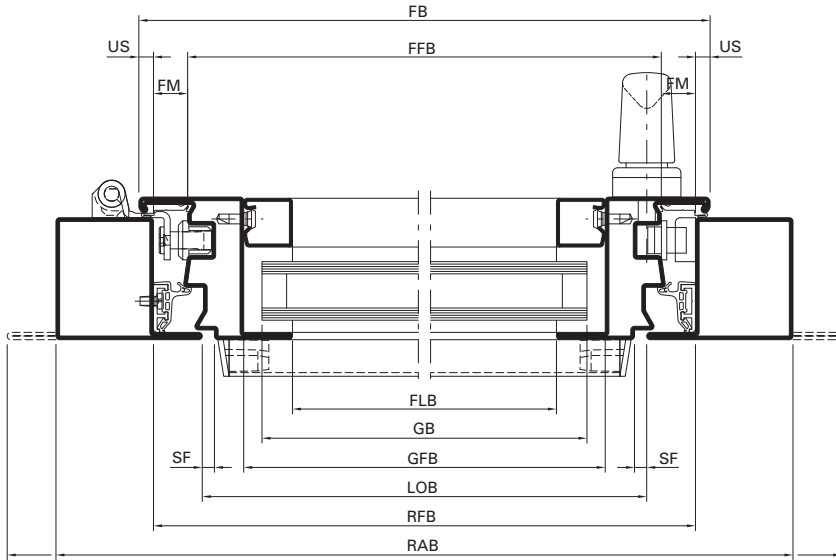

Massbezeichnungen

Dimensions cotées

Measurement descriptions

US	Überschlag	US	Recouvrement	US	Overlap
FM	Falzmass	FM	Dimension de la feuillure	FM	Rebate
SF	Schattenfuge	SF	Joint négatif	SF	Shadow gap
FH	Flügelhöhe	FH	Hauteur du vantail	FH	Vent height
FFH	Flügelfalzhöhe	FFH	Hauteur de feuillure du vantail	FFH	Vent rebate height
FLH	Flügel-Lichtmasshöhe	FLH	Hauteur vide lumière du vantail	FLH	Clear height dimension of vent
FB	Flügelbreite	FB	Largeur du vantail	FB	Vent width
FFB	Flügelfalzbreite	FFB	Largeur de feuillure du vantail	FFB	Vent rebate width
FLB	Flügel-Lichtmassbreite	FLB	Largeur vide lumière du vantail	FLB	Clear width dimension of vent
GH	Glashöhe	GH	Hauteur du verre	GH	Glass height
GFH	Glasfalzhöhe	GFH	Hauteur de feuillure du verre	GFH	Glazing rebate height
GB	Glasbreite	GB	Largeur du verre	GB	Glass width
GFB	Glasfalzbreite	GFB	Largeur de feuillure du verre	GFB	Glazing rebate width
LOH	Lichte Öffnungshöhe	LOH	Hauteur vide lumière	LOH	Clear opening height
RFH	Rahmenfalzhöhe	RFH	Hauteur de feuillure du dormant	RFH	Frame rebate height
RAH	Rahmnaussenhöhe	RAH	Hauteur extérieur du dormant	RAH	External frame height
LOB	Lichte Öffnungsbreite	LOB	Largeur vide lumière	LOB	Clear opening width
RFB	Rahmenfalzbreite	RFB	Largeur de feuillure du dormant	RFB	Frame rebate width
RAB	Rahmnaussenbreite	RAB	Largeur extérieur du dormant	RAB	External frame width
GF-B	Gangflügel-Breite	GF-FB	Largeur du vantail de service	GF-B	Access vent width
GF-FB	Gangflügel-Falzbreite	GF-FB	Largeur de feuillure du vantail de service	GF-FB	Access vent rebate width
GF-LB	Gangflügel-Lichtmassbreite	GF-LB	Vide lumière du vantail de service	GF-LB	Clear width dimension of access vent
GF-GB	Gangflügel-Glasbreite	GF-GB	Largeur du verre du vantail de service	GF-GB	Glass width of access vent
GF-GFB	Gangflügel-Glasfalzbreite	GF-GFB	Largeur de feuillure du verre du vantail de service	GF-GFB	Glazing rebate width of access vent
SF-B	Standflügel-Breite	SF-B	Largeur du vantail semi-fixe	SF-B	Secondary vent width
SF-FB	Standflügel-Falzbreite	SF-FB	Largeur de feuillure du vantail semi-fixe	SF-FB	Rebate width of secondary vent
SF-LB	Standflügel-Lichtmassbreite	SF-LB	Vide lumière du vantail semi-fixe	SF-LB	Clear width dimension of secondary vent
SF-GB	Standflügel-Glasbreite	SF-GB	Largeur du verre du vantail semi-fixe	SF-GB	Glass width of secondary vent
SF-GFB	Standflügel-Glasfalzbreite	SF-GFB	Largeur de feuillure du verre du vantail semi-fixe	SF-GFB	Glazing rebate width of secondary vent
S-FM	Stulpflügel-Falzmass	S-FM	Dimension de la feuillure fenêtre à deux vantaux	S-FM	Double vent rebate

U_f-Werte (EN 10077-2)

Valeurs U_f (EN 10077-2)

U_f values (EN 10077-2)

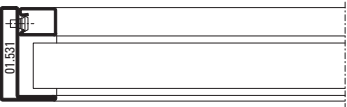
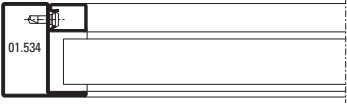
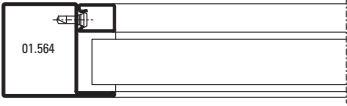
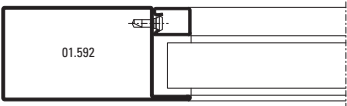
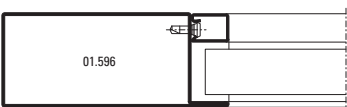
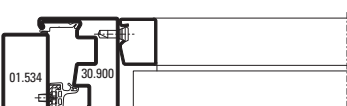
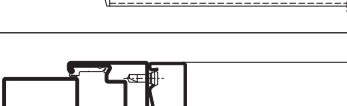
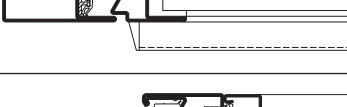
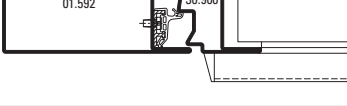
	Füllelementstärken Elements de remplissages Infill elements > 24 mm
	7,4 W/m²K
	6,5 W/m²K
	6,0 W/m²K
	5,2 W/m²K
	4,8 W/m²K
	5,9 W/m²K
	5,9 W/m²K
	5,6 W/m²K
	5,3 W/m²K

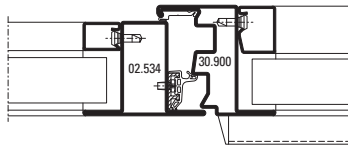
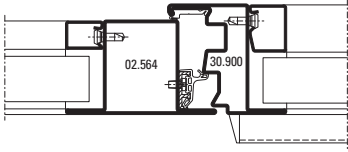
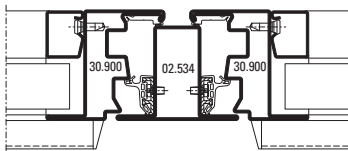
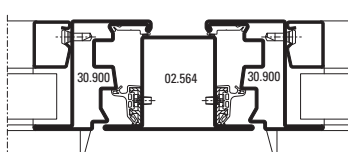
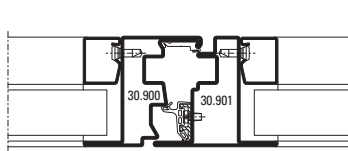
	Füllelementstärken Elements de remplissages Infill elements > 24 mm
	6,6 W/m²K
	6,3 W/m²K
	6,3 W/m²K
	6,2 W/m²K
	6,2 W/m²K

Die Werte gelten für Nassverglasung
 Les valeurs sont valable pour vitrage à mastic
 The values are valid for glazing with sealing

U_f-Werte (EN 10077-2)

Valeurs U_f (EN 10077-2)

U_f values (EN 10077-2)

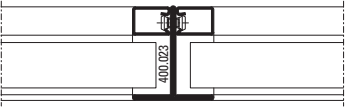
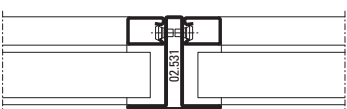
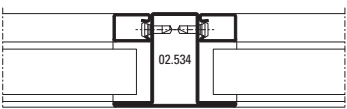
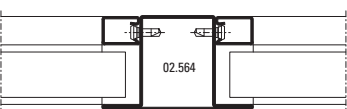
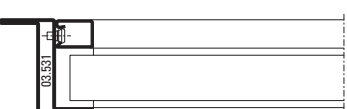
	Füllelementstärken Elements de remplissages Infill elements > 24 mm
	7,2 W/m²K
	7,2 W/m²K
	6,7 W/m²K
	6,1 W/m²K
	5,7 W/m²K

Die Werte gelten für Nassverglasung
 Les valeurs sont valable pour vitrage à mastic
 The values are valid for glazing with sealing

U_f-Werte (EN 10077-2)

Valeurs U_f (EN 10077-2)

U_f values (EN 10077-2)

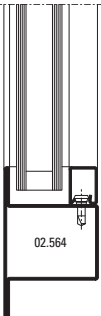
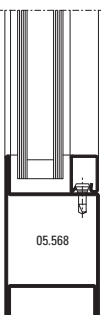
 <p>Füllelementstärken Elements de remplissages Infill elements > 24 mm</p>	
	6,0 W/m ² K
	5,3 W/m ² K

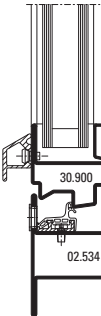
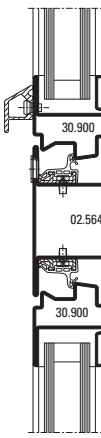
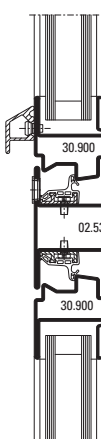
 <p>Füllelementstärken Elements de remplissages Infill elements > 24 mm</p>	
	5,9 W/m ² K
	6,2 W/m ² K
	6,3 W/m ² K

Die hier dargestellten U_f-Werte basieren auf internen Berechnungen (EN ISO 10077-2), welche mit Prüfnachweisen vom ift Rosenheim korrelieren.

Les valeurs U_f ici illustrées se basent sur des calculs internes (EN ISO 10077-2) en corrélation avec les preuves d'essai de l'ift Rosenheim.

The U_f values illustrated here are based on internal calculations (EN ISO 10077-2), which correlate with test certificates from ift Rosenheim.

**U_f-Werte Edelstahl-Profile
 (EN 10077-2)**

**Profils acier Inox valeurs U_f
 (EN 10077-2)**

**Stainless steel profiles U_f values
 (EN 10077-2)**

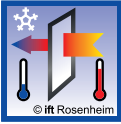
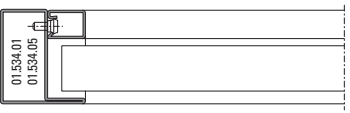
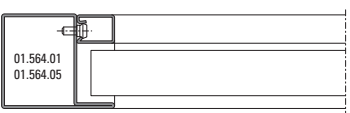
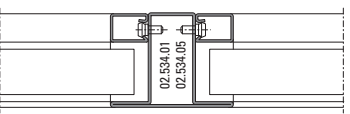
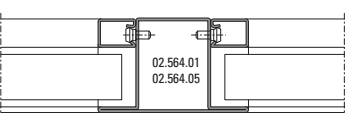

	Füllelementstärken Elements de remplissages Infill elements > 24 mm
	5,4 W/m ² K
	4,9 W/m ² K
	5,4 W/m ² K
	4,8 W/m ² K

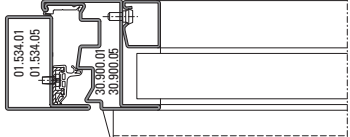
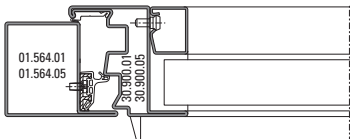
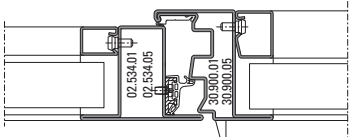
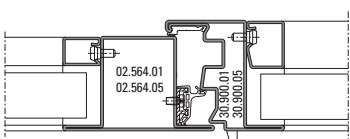
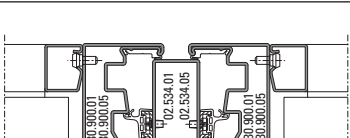
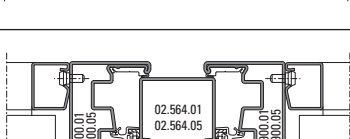

	Füllelementstärken Elements de remplissages Infill elements > 24 mm
	5,3 W/m ² K
	5,1 W/m ² K
	5,5 W/m ² K
	5,2 W/m ² K
	5,3 W/m ² K
	5,2 W/m ² K

Die Werte gelten für Nassverglasung
 Les valeurs sont valable pour vitrage à mastic
 The values are valid for glazing with sealing

**U_f-Werte Edelstahl-Profile
 (EN 10077-2)**

**Profils acier Inox valeurs U_f
 (EN 10077-2)**

**Stainless steel profiles U_f values
 (EN 10077-2)**



	<p>Füllelementstärken Elements de remplissages Infill elements > 24 mm</p>
	<p>5,4 W/m²K</p>
	<p>4,2 W/m²K</p>
	<p>5,3 W/m²K</p>

Leistungswerte
 Fenster aus Stahl und Edelstahl

Caractéristiques de performances
 Fenêtres en acier et acier Inox

Performance values
 Windows made of steel and stainless steel

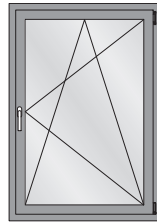





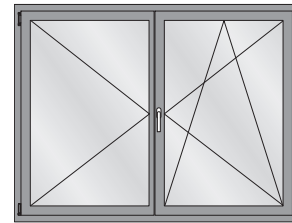

FFB = 1080 mm
 FFH = 2380 mm

Max. Fläche:
 Surface max.:
 Max. surface:
 2,3 m²



FFB = 2100 mm
 FFH = 2380 mm

Max. Fläche:
 Surface max.:
 Max. surface:
 2,3 m²

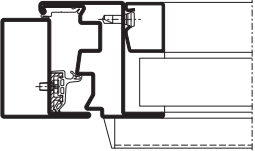
	 EN 12208	 EN 12207	 EN 12210	 EN 12208	 EN 12207	 EN 12210
	Klasse E900* Classe E900* Class E900*	Klasse 4* Classe 4* Class 4*	Klasse C4* Classe C4* Class C4*	Klasse E750 Classe E750 Class E750	Klasse 4 Classe 4 Class 4	Klasse C3 Classe C3 Class C3
Größenänderungen Variations dimensionnelles Size changes	-100%	-100%	-100%	-100%	-100%	-100%

*Die Werte gelten auch für
 Festverglasungen

*Les valeurs sont valable aussi
 pour vitrages fixe

*The values are valid also for
 fixed lights

 EN ISO 140-3	Schallschutz R_w (C , C_{tr}) (dB) Isolation phonique R_w (C , C_{tr}) (dB) Sound insulation R_w (C , C_{tr}) (dB)	bis R_w 43 dB (-2; -5) jusqu'à R_w 43 dB (-2; -5) up to R_w 43 dB (-2; -5)
---	---	--

CE Kennzeichnung und Leistungserklärungen

Alle nötigen Unterlagen und Anleitungen zur CE-Kennzeichnung finden Sie unter

www.extranet.jansen.com

Ebenfalls finden Sie unter dieser Adresse alle Leistungserklärungen unserer Beschläge.

JANIssoft

JANIssoft ermöglicht die Planung, Kalkulation und Konstruktion von Jansen Systemen für Fenster, Türen und Fassaden in 2D sowie 3D. Mit der neuen Version können Planer und Verarbeiter Angebote und Bestellungen mit den entsprechenden Detailzeichnungen und Berechnungen einfach erstellen. Dank der optimierten Softwarefunktionen lässt sich der Prozess von der Arbeitsvorbereitung über die Fertigung noch effizienter gestalten.

Online-Zugriff

extranet.jansen.com/bestellkatalog
Über diesen Link haben Sie direkten Zugriff auf die einzelnen Kapitel des Bestellkatalogs in Form von PDFs und können die darin verlinkten detaillierten CAD-Zeichnungen (DWG- und DXF-Dateien) gratis downloaden.

Voraussetzung ist Ihre Registrierung im Jansen Extranet.

Erklärung

DXF

DWG

Sie können die Zeichnungen in den Formaten DXF und/oder DWG herunterladen. Klicken Sie auf das entsprechende Icon und der Download erfolgt.

Der Hinweis Artikelbibliothek bedeutet, dass Sie mit einem Klick die gesamte Artikelbibliothek des entsprechenden Systems herunterladen (Profile, Glasleisten, Zubehör etc.).

CAD-Beschlagsartikel finden Sie aufgrund der grossen Datenmenge per Klick auf einen separaten Link im Extranet.

Marquage CE et déclarations de performance

Tous les documents et instructions relatifs au marquage CE se trouvent sur le site

www.extranet.jansen.com

Vous trouverez également à cette adresse toutes les déclarations de performance de nos ferrures.

JANIssoft

JANIssoft permet l'étude, le calcul et la construction de systèmes Jansen en 2D et 3D pour les fenêtres, les portes et les façades. La nouvelle version permet aux projeteurs et aux transformateurs d'établir facilement des offres et des commandes avec les plans de détail et les calculs. Des préparatifs du travail à la commande de la machine, le processus peut être coordonné de manière encore plus efficace grâce aux fonctions optimisées du logiciel.

Accès en ligne

extranet.jansen.com/catalogue
Ce lien vous donne un accès direct aux différents chapitres du catalogue de commande au format PDF et vous permet de télécharger gratuitement les dessins DAO (fichiers DWG et DXF) détaillés mis en lien qu'il contient.

Vous devez pour cela être enregistré dans l'Extranet Jansen.

Explication

DXF

DWG

Vous pouvez télécharger les dessins aux formats DXF et/ou DWG. Cliquez sur l'icône correspondante et le téléchargement s'effectuera.

L'indication Bibliothèque des articles signifie que vous téléchargez la totalité de la bibliothèque des articles du système donné (profilés, parclozes, accessoires etc.).

En raison de la grande quantité de données, vous trouverez les articles de ferrure DAO en cliquant sur un lien séparé de l'Extranet.

CE marking and declarations of performance

You can find all the necessary documents and instructions on CE marking at

www.extranet.jansen.com

At this address you can also find all declarations of performance for our fittings.

JANIssoft

JANIssoft allows Jansen systems for windows, doors and façades to be planned, calculated and designed in 2D and 3D. Using the new version, developers and fabricators can easily create quotations and orders with the corresponding detailed drawings and calculations. Thanks to optimised software functionality, the procedure from process planning to fabrication can be made even more efficient.

Online access

extranet.jansen.com/ordercatalogue
Via this link, you can enjoy direct access to the individual chapters of the order manual in the form of PDFs and download the detailed CAD drawings linked to them (DWG and DXF files) free of charge.

To do so, you are required to register for the Jansen Extranet.

Explanation

DXF

DWG

You can download the drawings in DXF and/or DWG format. Click on the relevant icon to begin the download.

The item "Article library" means that you download the entire article library for the corresponding system with one click (profiles, glazing beads, accessories etc.).

Due to the large volume of data, you will find CAD fittings articles by clicking on a separate link in the Extranet.

Verarbeitungs-Hinweise
Indications d'usage
Assembly instructions

Jansen-Economy 50 Fenster
Jansen-Economy 50 fenêtres
Jansen-Economy 50 windows

**Bedienungs-, Pflege- und
Wartungsanleitung siehe
Dokumentation 598.461**

**Instructions d'emploi,
d'entretien et de maintenance
voir documentation 598.468**

**Operating and maintenance
instructions see
documentation 598.467**

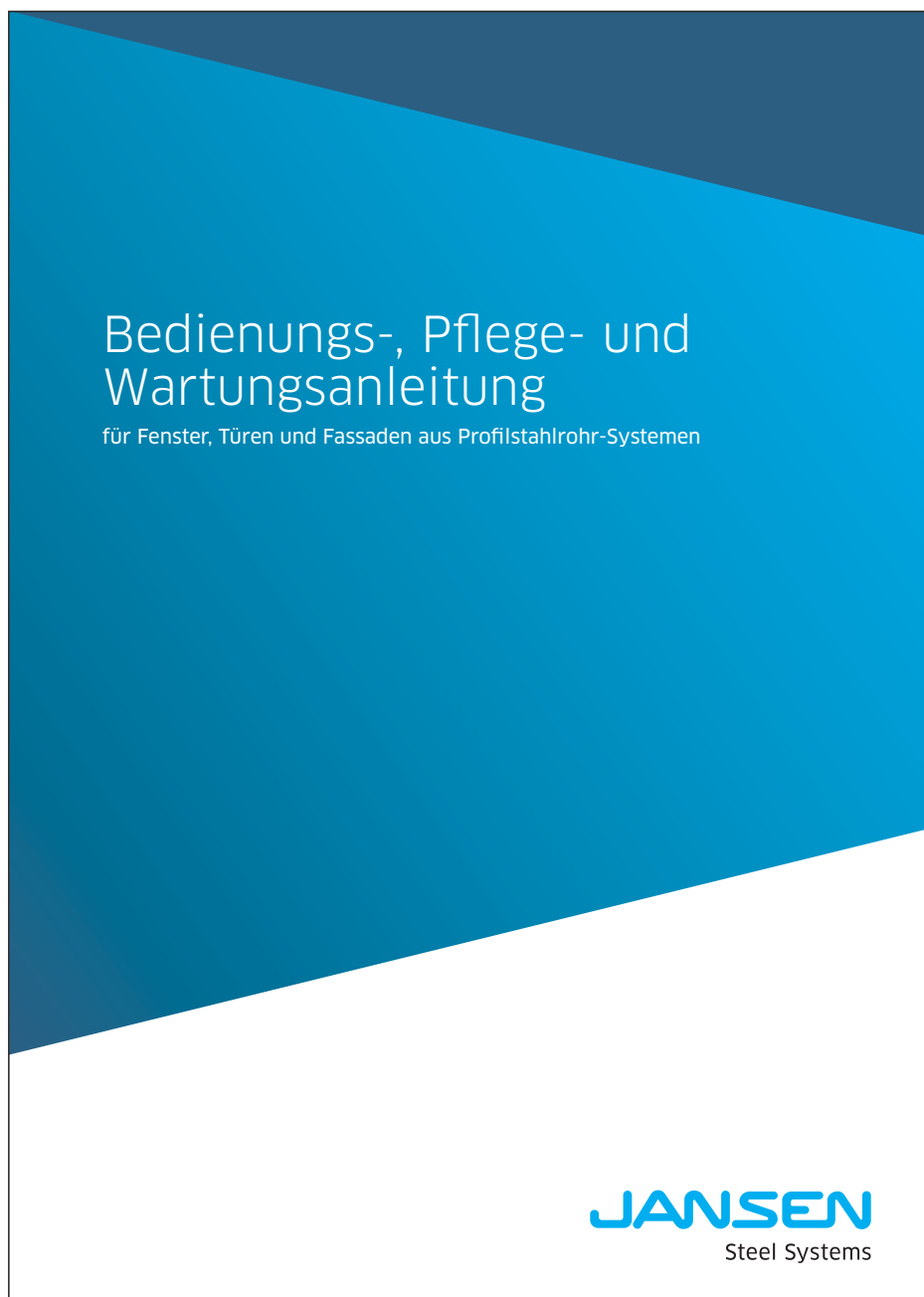

Jansen AG

Steel Systems
Industriestrasse 34
9463 Oberriet
Schweiz
jansen.com

JANSEN
Configure to Inspire