



Doors & windows

Non-insulated profile systems
made from steel and stainless steel

Strong views. Not insulated, but fully functional.

Doors and windows symbolise openness and provide a way in for people, light and air. But they also protect from external influences. The individual requirements for thermal insulation and sound reduction or burglar and bullet resistance determine how doors and windows are to be constructed.

The non-insulated profile systems from Jansen for windows and doors in steel or stainless steel are suitable for use in parts of a building in which there are thermal insulation requirements to fulfil and therefore no insulating properties are required.

The door and window systems of the Jansen Economy series are suitable for dry and wet glazing and are economical and flexible in use. With their minimal basic depths, the complete systems can even be flush-fitted in narrow constructions and still guarantee maximum stability. The door systems are also available with easy-access thresholds.

The range includes the following profile series:

- Jansen-Economy 50 doors (steel and stainless steel): with a basic depth of 50 mm, suitable for flush-fitted single and double-leaf doors and fixed glazing.
- Jansen-Economy 60 doors (steel): with a basic depth of 60 mm, suitable for large, flush-fitted single and double-leaf door constructions and fixed glazing.
- Jansen Economy 50 windows (steel and stainless steel): with a basic depth of 50 mm, suitable for side-hung, turn/tilt, double and bottom-hung vents.

The Jansen Economy systems have successfully passed the tests laid down in the product standard EN 14351-1.

On this basis, manufacturers can label windows and external doors with the CE mark which is obligatory throughout the EU.



Jansen-Economy Doors and windows



Elegant solutions for every requirement

This profile series is characterised by its simple profile geometry, slender structures and maximum stability. This means streamlined production and economical installation. Single and double-leaf doors, with moving and/or fixed glazing toplights and side lights: constructions with Jansen-Economy 50 and 60 offer potential for creative solutions to

meet any building requirements. The Jansen-Economy 50 and Jansen-Economy 60 door constructions have an impressive flush-fitted design, continuous shadow gaps inside and outside, and a double rebate gasket. An automatic seal or rebate gasket can be fitted around the threshold if required.



Jansen-Economy 60 anti-finger-trap doors: Safety and design perfectly combined

The rounded half profiles minimise the risk of injury at the secondary closing edge. This then prevents crushing and shearing points as per DIN 18650. With maintenance-free, high-performance hinge bushes, Jansen-Economy 60 anti-finger-trap doors are particularly suitable for buildings with high frequency use by the public, e.g.

shopping centres, schools or hospitals. Jansen-Economy anti-finger-trap doors meet the product standard EN 14351-1 for external doors and are CE certified. The anti-finger-trap doors are compatible with the Janisol profile range. Integrated door closers and automatic side-hung door drives can also be installed.



Jansen-Economy windows – en vogue with a slimline look

With a basic depth of just 50 mm (or 58.5 mm) for the vent profile, Jansen-Economy 50 is also suitable for window vents: side-hung, turn/tilt, double or bottom-hung vents. Fully-tested, system-specific fittings are available for all opening types,

complemented by attractive window handles in aluminium or stainless steel. Jansen-Economy 50 window constructions have a centre gasket in the area around the window rebate plus a rebate gasket on the room side.



Example of Jansen-Economy 50 doors

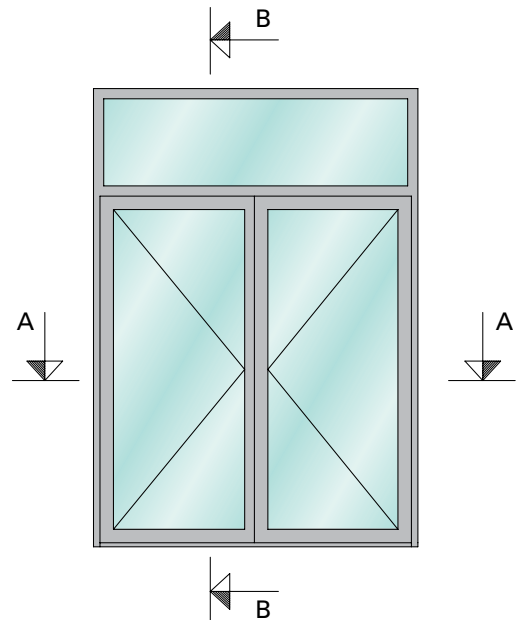
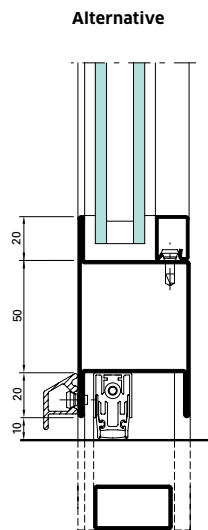
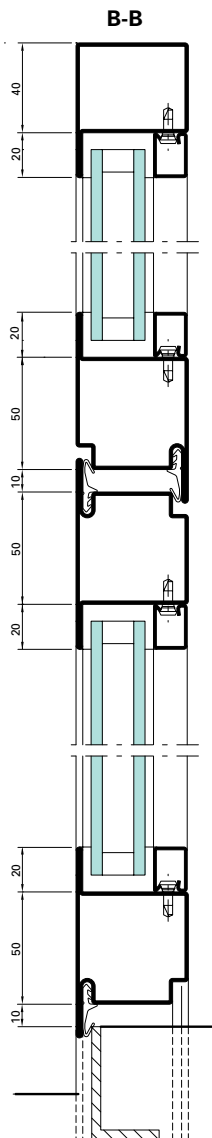
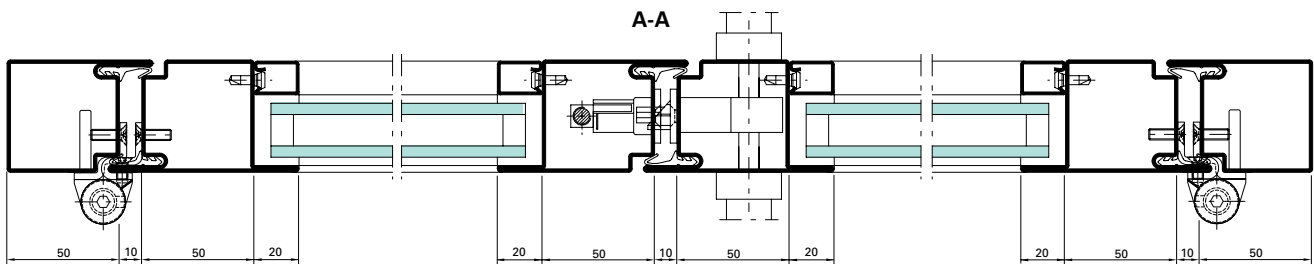

Example of Jansen-Economy 50 windows

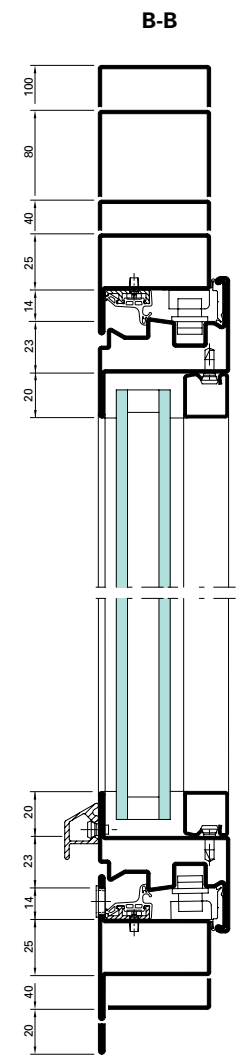
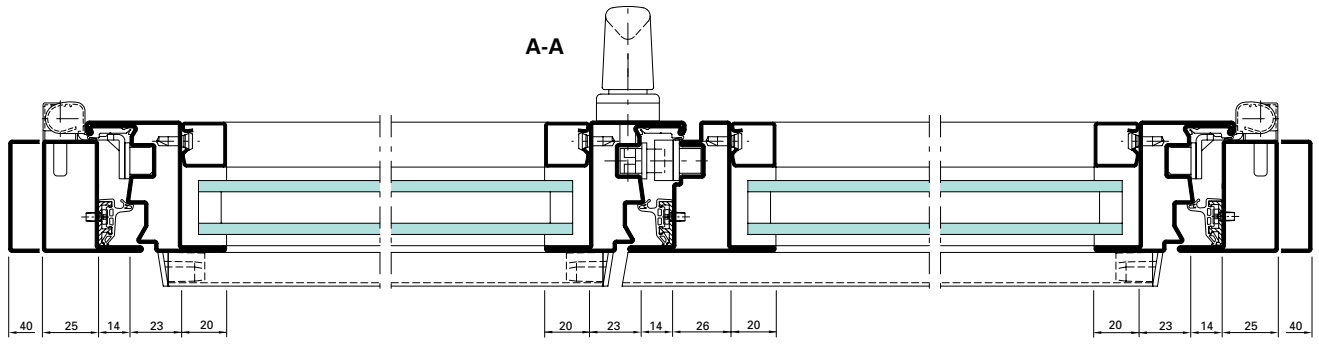

Verdeckt liegender Fensterbeschlag

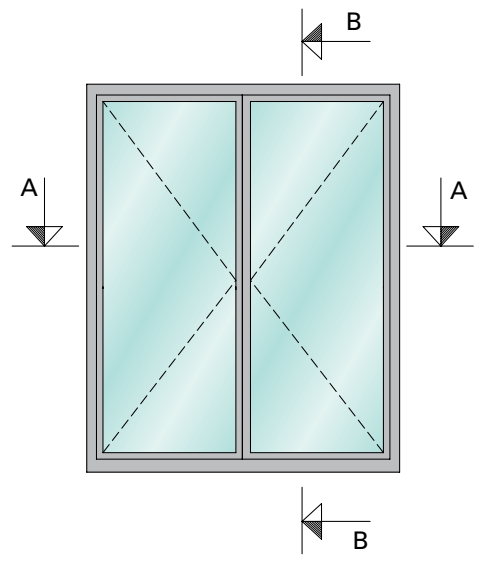
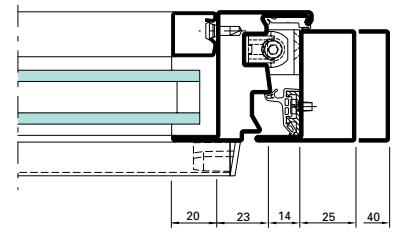



Jansen-Economy 50 Stainless steel



The perfect choice for every requirement

Jansen-Economy 50 stainless steel profiles are now available in two different qualities. Both modern materials 1.4404 (AISI 316L) and 1.4307 (AISI 304L) are based on the latest findings in steel research. They are specially tailored to architectural and functional requirements in normal or in aggressive atmospheres. Use specific to requirements affords significant optimisation of material

costs. Profile shapes and basic depths are identical to Jansen-Economy steel profiles. This makes it easy for the developer to combine the profile series and for the fabricator to use identical accessories.

An attractive range of stainless steel fittings has been added to the comprehensive range of products for windows and doors.

Material 1.4307 (AISI 304L) is preferred for normal, non-aggressive atmospheres without chlorine and salt concentrations:

- In a rural environment
- In residential and industrial areas
- Indoors

Material 1.4404 (AISI 316L) is also resistant to atmospheres containing chloride and salt. It is therefore particularly suitable for use:

- In industrial areas
- In coastal areas
- In areas with strict hygiene requirements
- Near roads (with a salt load)



Example of Jansen-Economy 50 stainless steel doors

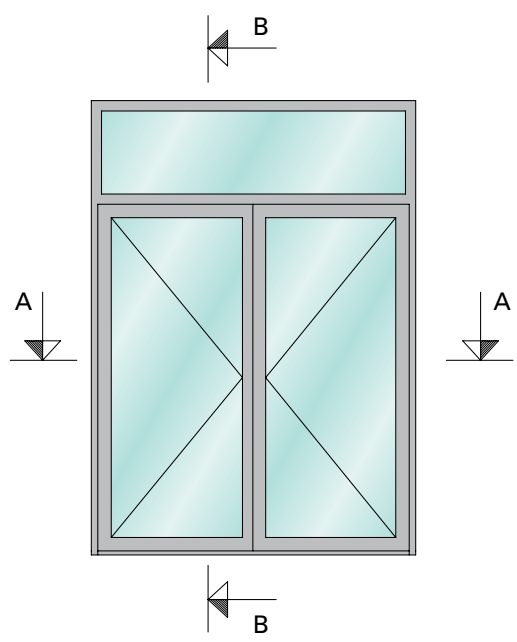
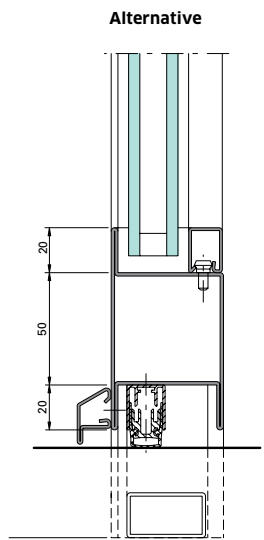
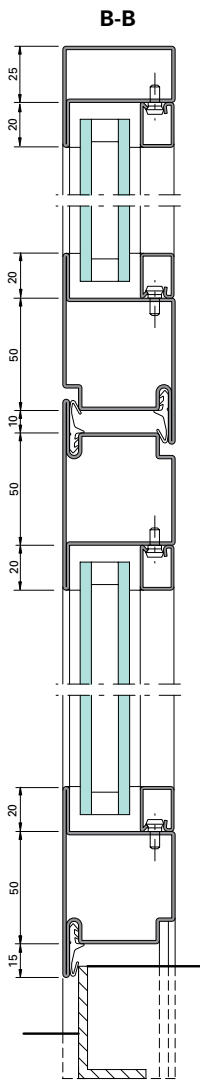
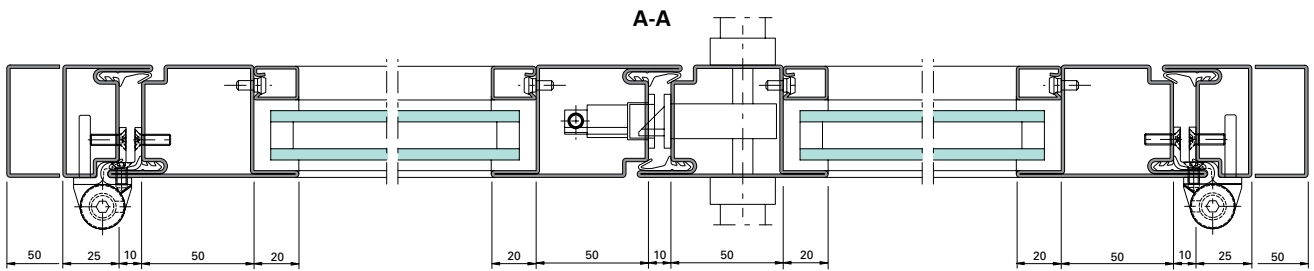

Example of Jansen-Economy 50 stainless steel windows

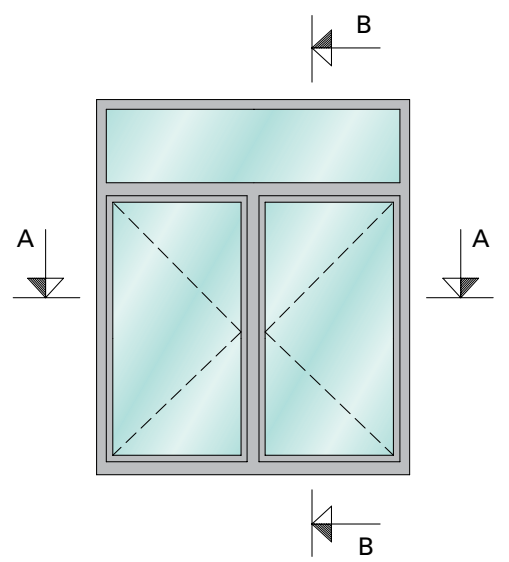
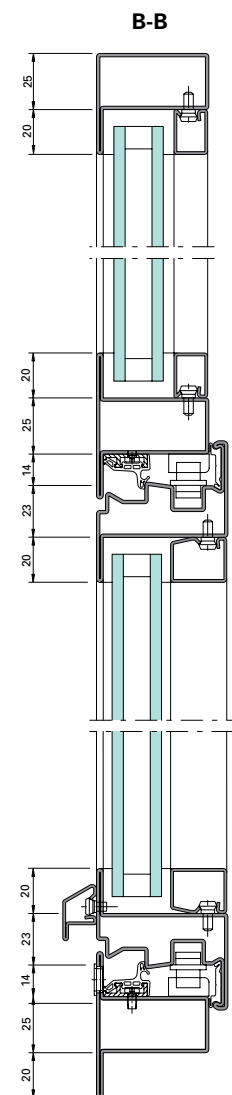
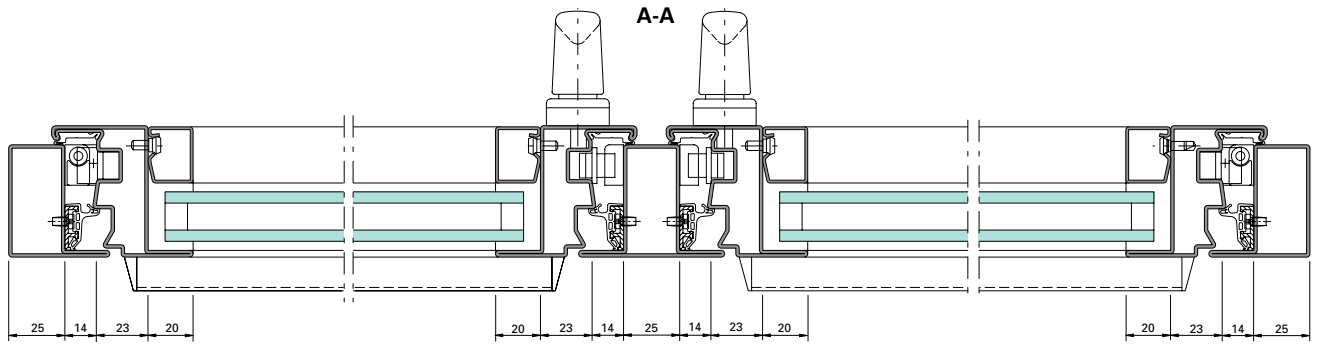

Profile range

Jansen-Economy 50

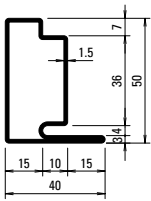

30.006
30.006 Z
[30.006.01](#)
[30.006.03](#)
[30.006.05](#)
[30.006.07](#)

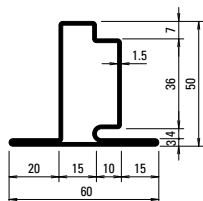

30.106
30.106 Z
[30.106.01](#)
[30.106.03](#)
[30.106.05](#)
[30.106.07](#)

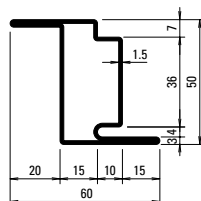

30.406
30.406 Z
[30.406.01](#)
[30.406.03](#)
[30.406.05](#)
[30.406.07](#)

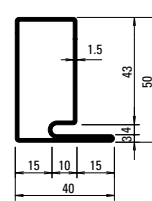

30.021
30.021 GV+GC

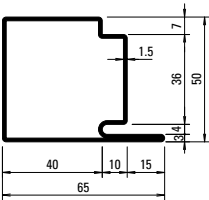

30.007
30.007 Z
[30.007.01](#)
[30.007.03](#)
[30.007.05](#)
[30.007.07](#)

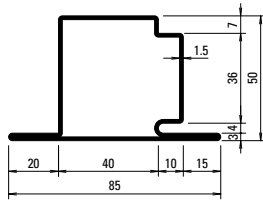

30.107
30.107 Z
[30.107.01](#)
[30.107.03](#)
[30.107.05](#)
[30.107.07](#)

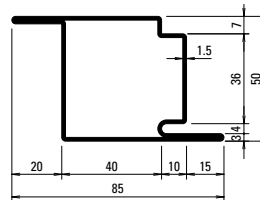

30.407
30.407 Z
[30.407.01](#)
[30.407.03](#)
[30.407.05](#)
[30.407.07](#)

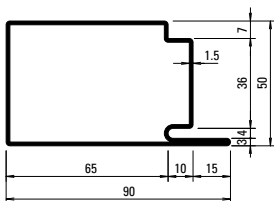

30.008
30.008 Z

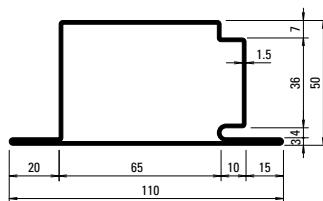

30.108
30.108 Z

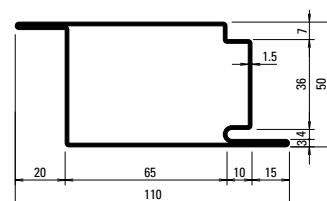

30.408
30.408 Z

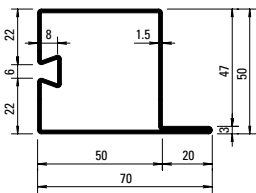

32.388
32.388 Z

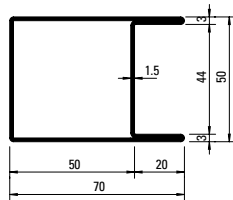

04.568
04.568 Z

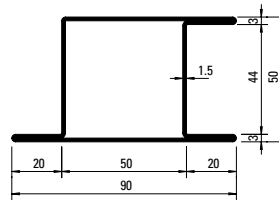

05.568
05.568 Z
05.568.01
05.568.03
05.568.05
05.568.07

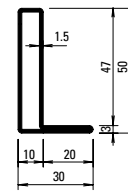

01.531
01.531 Z

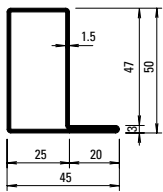

01.534
01.534 Z
01.534.01
01.534.03
01.534.05
01.534.07

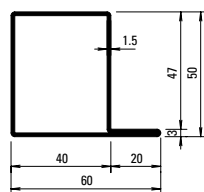

01.564
01.564 Z
01.564.01
01.564.03
01.564.05
01.564.07

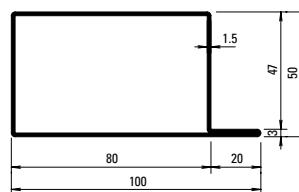

01.592
01.592 Z

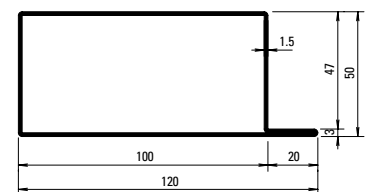

01.596
01.596 Z

Z = made from hot-dip galvanised astrip

GV+GC = outside galvanised and yellow chromated

01 = Stainless steel, bright, material 1.4404 (AISI 316L)

03 = Stainless steel polished, grain 220-240 material 1.4404 (AISI 316L)

05 = Stainless steel, bright, material 1.4307 (AISI 304L)

07 = Stainless steel polished, grain 220-240 material 1.4307 (AISI 304L)

Profile range

Jansen-Economy 50

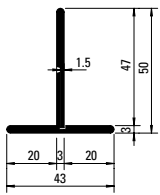

400.023
400.023 Z

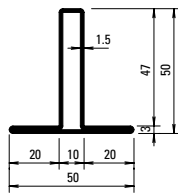

02.531
02.531 Z

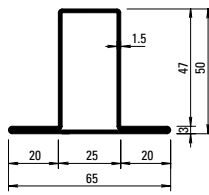

02.534
02.534 Z
02.534.01
02.534.03
02.534.05
02.534.07

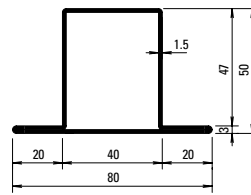

02.564
02.564 Z
02.564.01
02.564.03
02.564.05
02.564.07

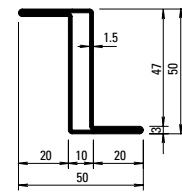

03.531
03.531 GV+GC

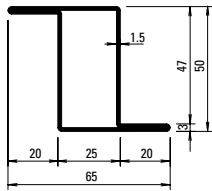

03.534
03.534 Z
03.534.01
03.534.03
03.534.05
03.534.07

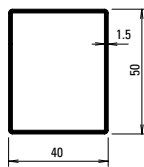

400.048
400.048 GV+GC

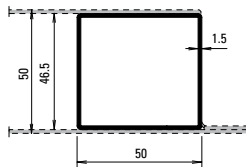

400.049
400.049 GV+GC

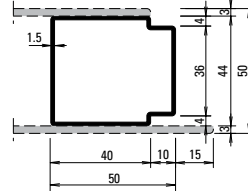

81.009
81.009 GV+GC

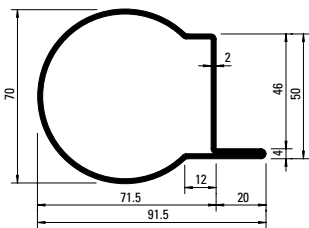

60.153
60.153 GV+GC

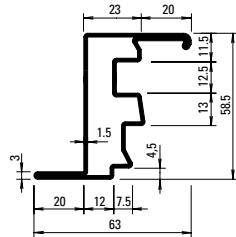

30.900
30.900 Z
30.900.01
30.900.03
30.900.05
30.900.07

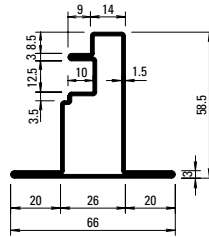

30.901
30.901 GV+GC

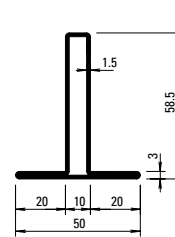

02.636
02.636 GV+GC



Profile range Jansen-Economy 60

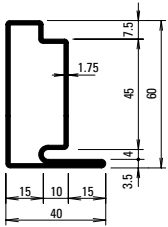

30.018
30.018 Z

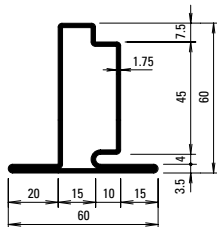

30.118
30.118 Z

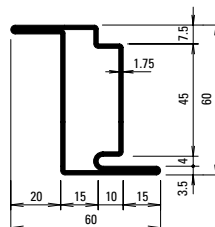

30.418
30.418 Z

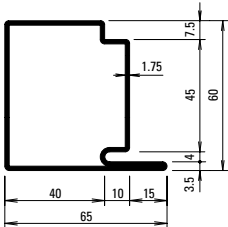

30.019
30.019 Z

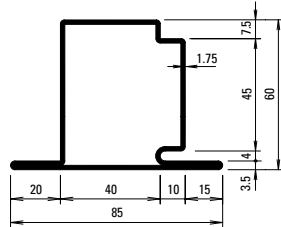

30.119
30.119 Z

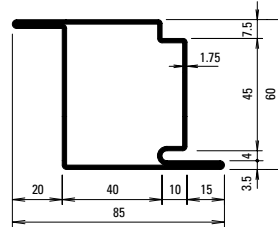

30.419
30.419 Z

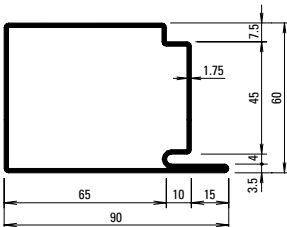

30.017
30.017 Z

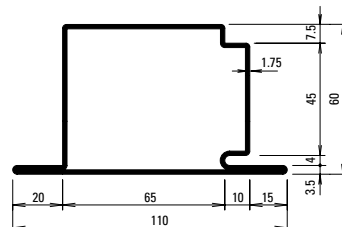

30.117
30.117 GV+GC

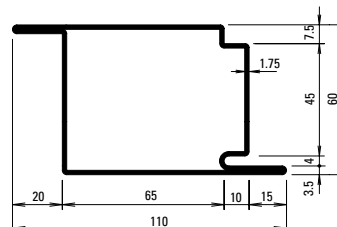

30.415
30.415 GV+GC

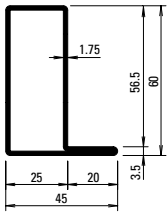

01.634
01.634 Z

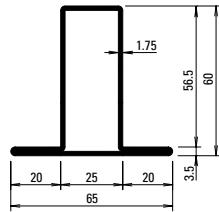

02.634
02.634 Z

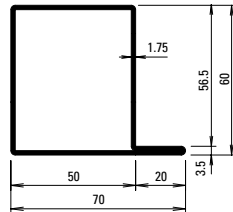

01.684
01.684 Z

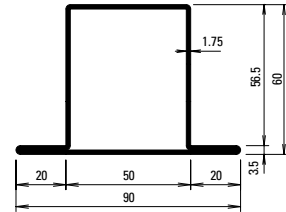

02.684
02.684 Z

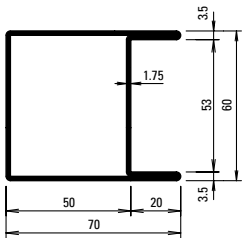

04.637
04.637 Z

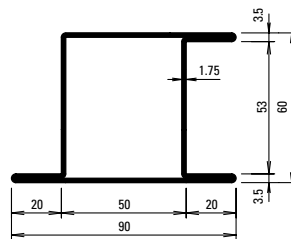

05.637
05.637 Z

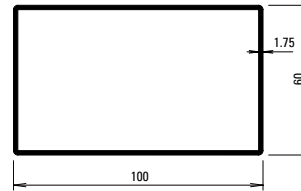

400.051
400.051 GV+GC

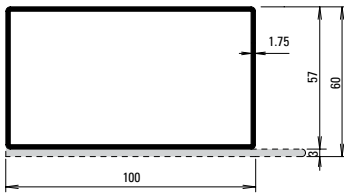

400.050
400.050 GV+GC

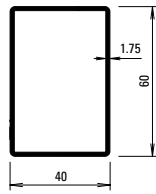

400.052
400.052 GV+GC

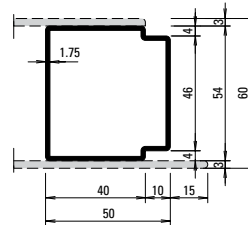

81.010
81.010 GV+GC

Z = made from hot-dip
galvanised astrip

GV+GC = outside galvanised and
yellow chromated

Jansen-Economy 60 Folding wall



Steel folding wall

This folding wall is based on the non-insulated Jansen-Economy 60 system. Flexible in use, the folding wall system can be used as a room divider as well as for outside areas, and can be inward or outward-opening. A compatible range of fittings and accessories ensures proper, smooth and quiet operation.

A range of designs is available for the threshold. Depending on the size and loading, profiles with a face width of 25 mm or 50 mm can be used. The load-bearing capacity of the top running gear is up to 200 kg, which in turn permits leaf weights of up to 100 kg.



Example of Jansen-Economy 60 folding wall

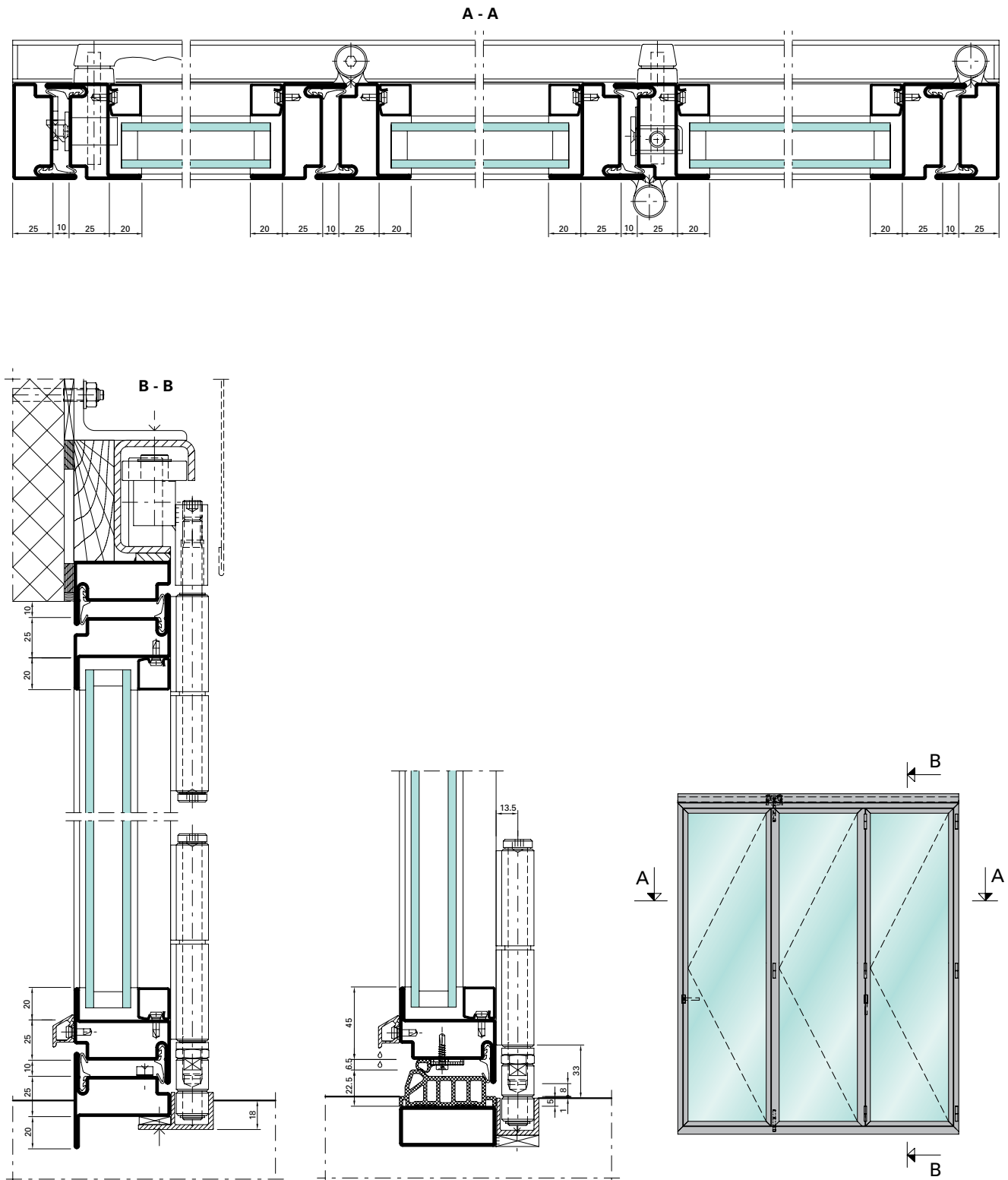

Folding and sliding doors

Manual and automatic



For folding and sliding doors, Jansen provides a coordinated range of profiles with basic depths of 50, 60 and 80 mm, as well as accessories and fittings to meet all requirements. The folding doors can be rebated behind, in or in front of the opening. They can be designed as inward or outward-opening doors, and with virtually any leaf division. Sliding doors come into their own when a space-saving design is required. Infill

panels or glass infills can be used to meet increased demands for high-quality products.

The range of profiles and gaskets is suitable for both manually and automatically operated door systems. The complementary fittings are also fully tested and guarantee a long service life with reliable, quiet and smooth operation.

Jansen folding doors have been tested in accordance with EN 13241-1 together with drives from Gilgen, a leading drive technology company. In this way, we provide our partners with the necessary prerequisites for CE marking, which is a legal requirement for both manual and automatic doors.

Profile range

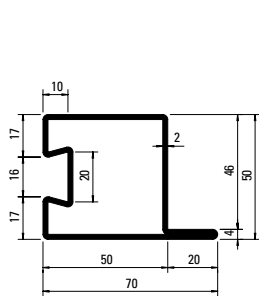

32.373

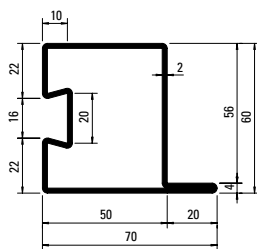

32.374

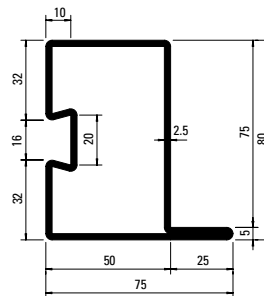

32.382

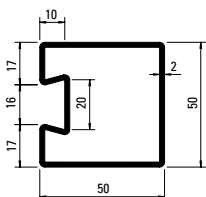

76.731

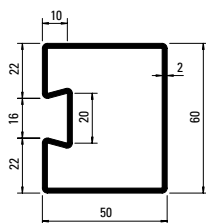

76.732

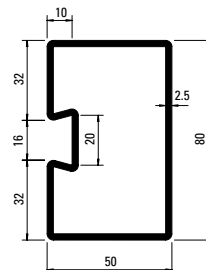

76.733

Example of folding doors

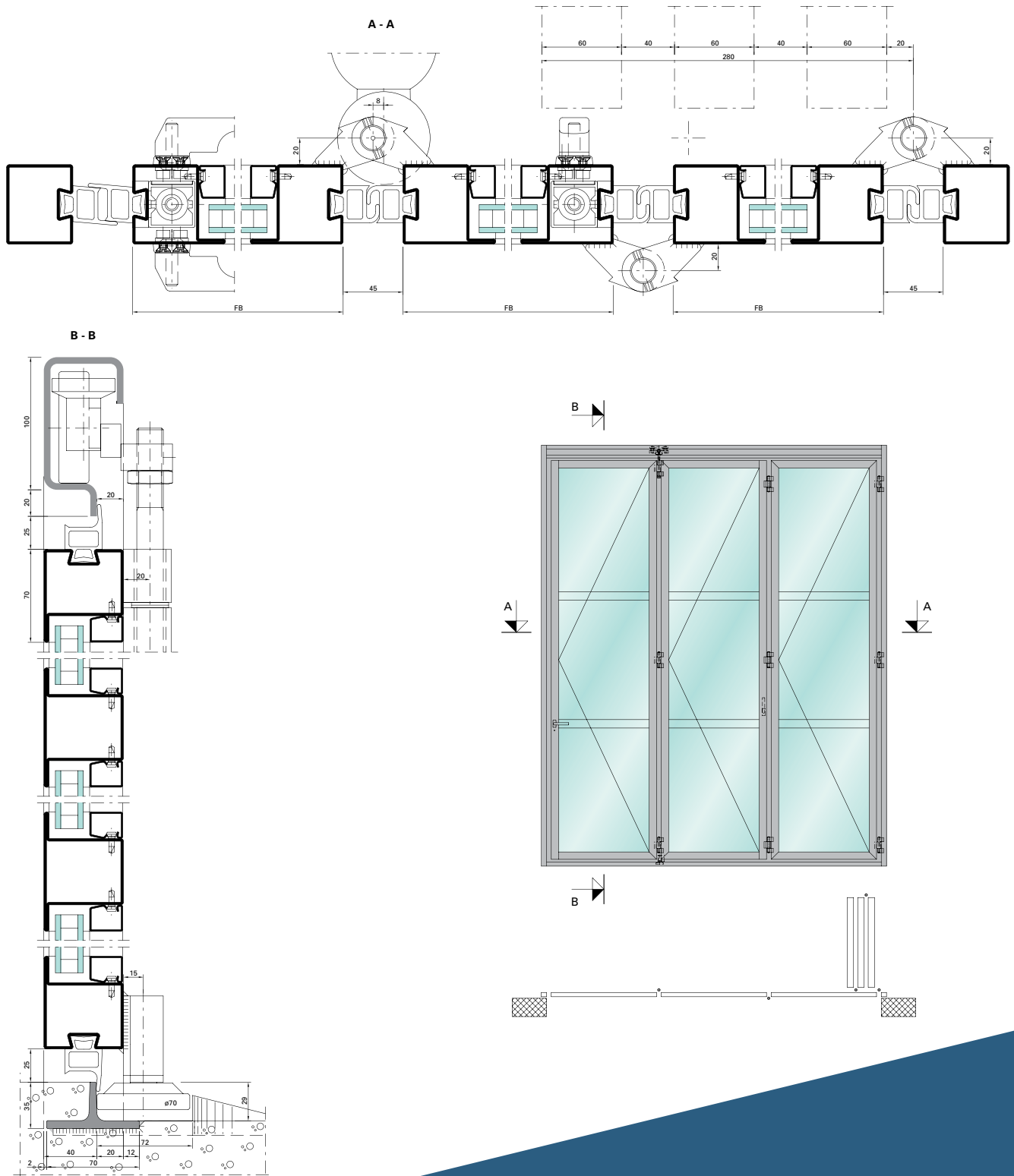



Standard profiles

Doors and windows

The comprehensive range of profiles with basic depths of 40, 50, 60 and 80 mm opens up design options for doors and windows. Functional and attractive single and double-vent designs are possible, with side sections and toplights, as curved doors or swing doors. With fixed glazing, the excellent structural properties of steel are clear to see. They allow slender frame dimensions and torsion-resistant units, even for large constructions.

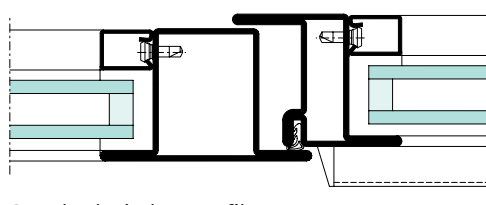

Standard window profiles

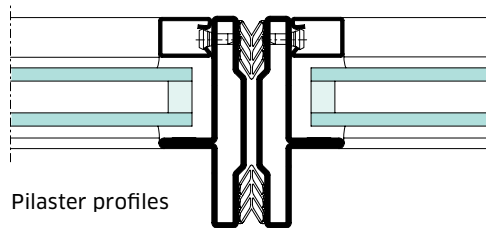

Pilaster profiles

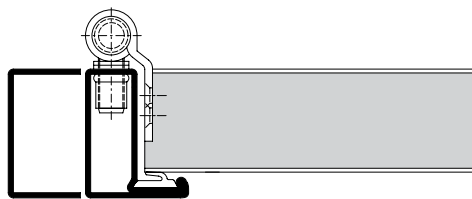

Frame doors

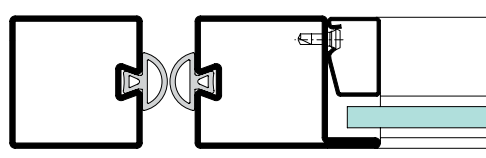

Swing doors

Profile range

Standard profiles 50 mm

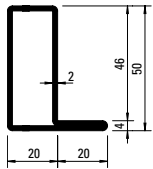

01.535

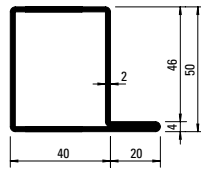

01.565

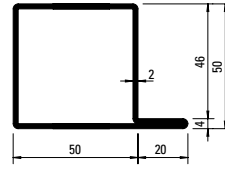

01.570

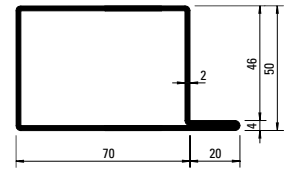

01.590

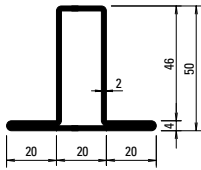

02.535

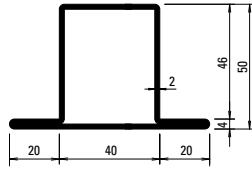

02.565

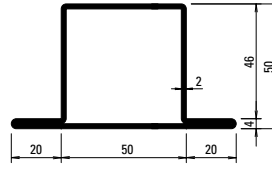

02.570

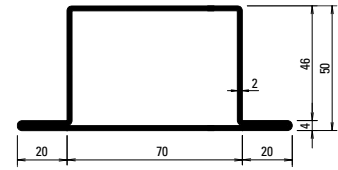

02.590

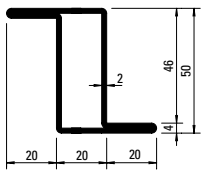

03.535

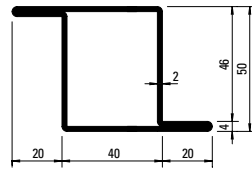

03.565

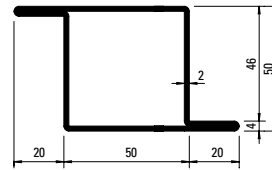

03.570

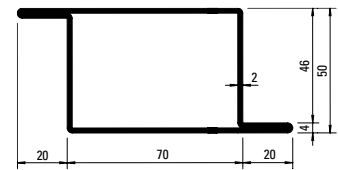

03.590

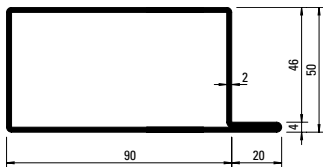

01.587

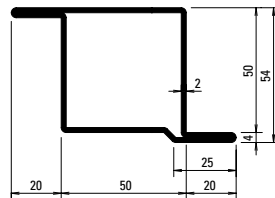

13.570

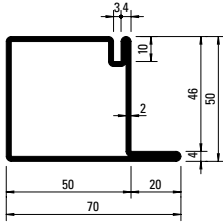

30.030

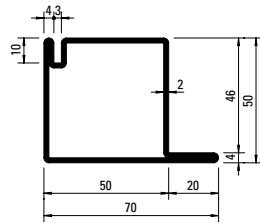

30.050

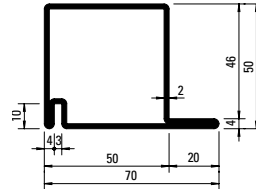

30.085

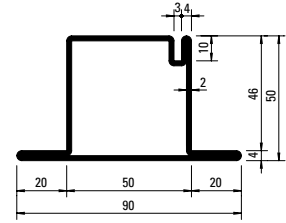

30.235

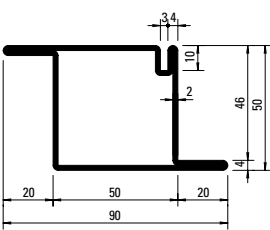

30.265

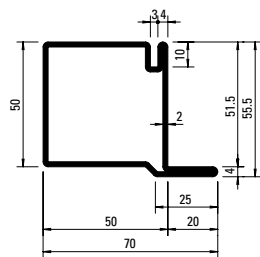

30.430

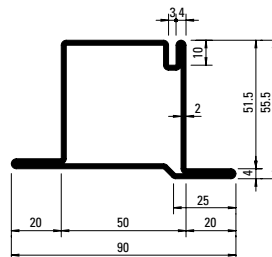

30.628

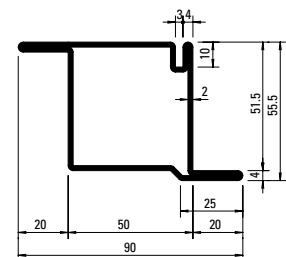

30.465

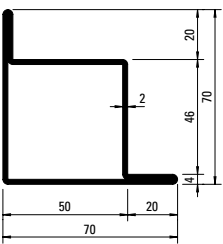

06.570

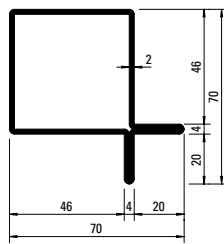

07.570

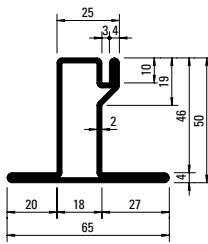

30.600

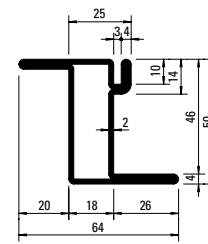

30.620

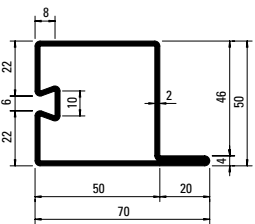

32.366

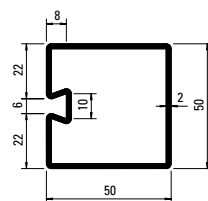

76.726

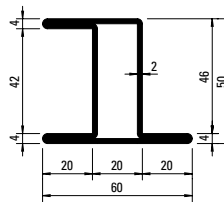

05.535

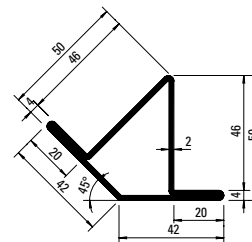

61.410

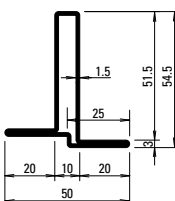

12.530

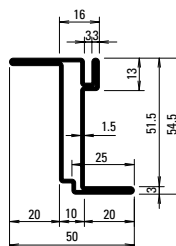

30.611

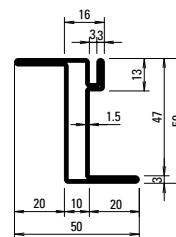

30.612

Profile range

Standard profiles 50 mm

Frame doors

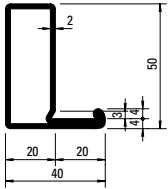

32.109

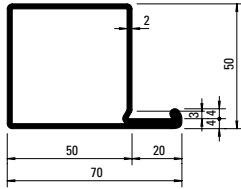

32.042

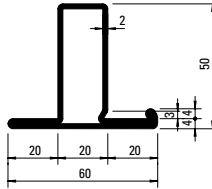

32.085

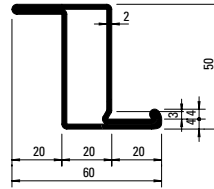

32.105

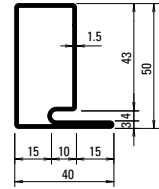
30.021
30.021 GV+GC

Pilaster profiles

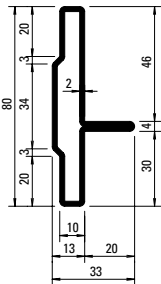

20.060

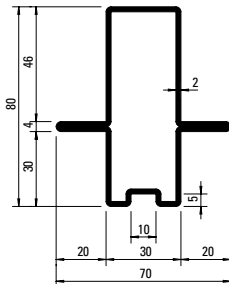

23.380



Example of doors and windows

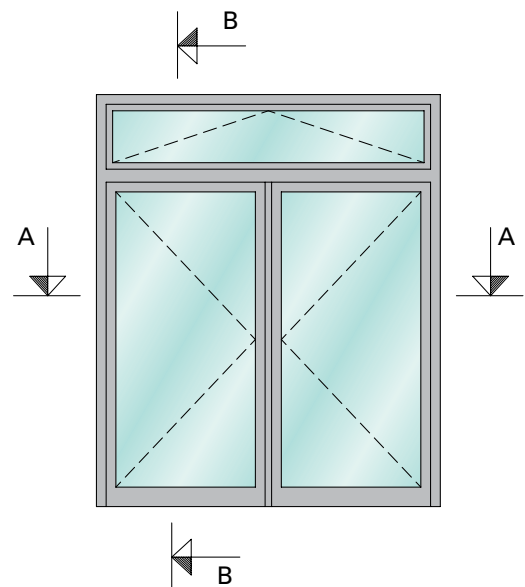
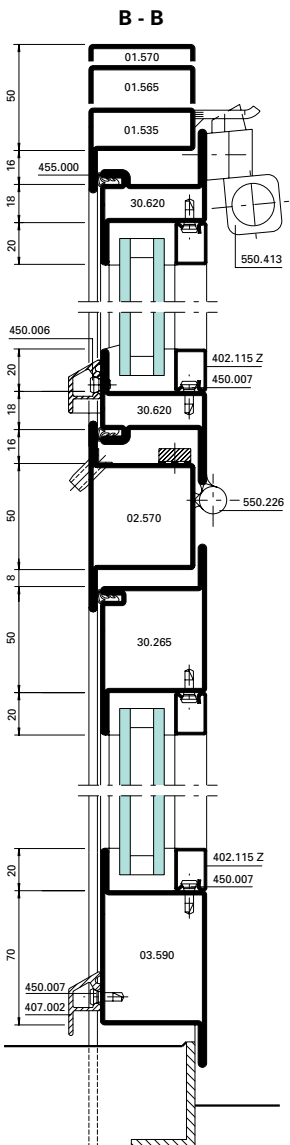
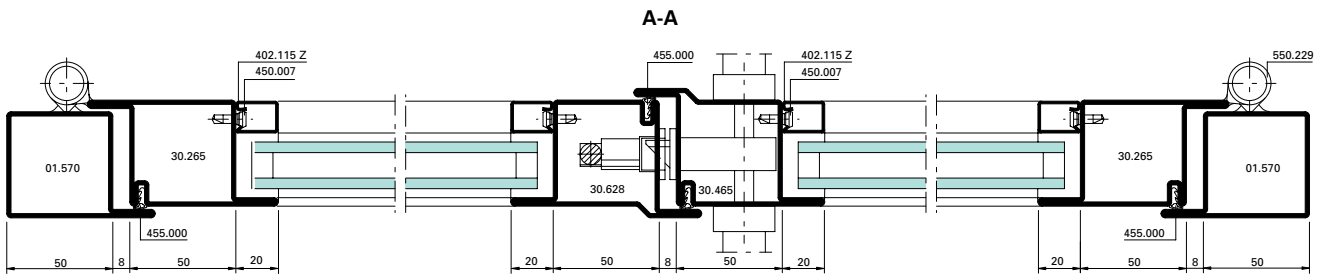

Example of frame doors and pilaster profiles

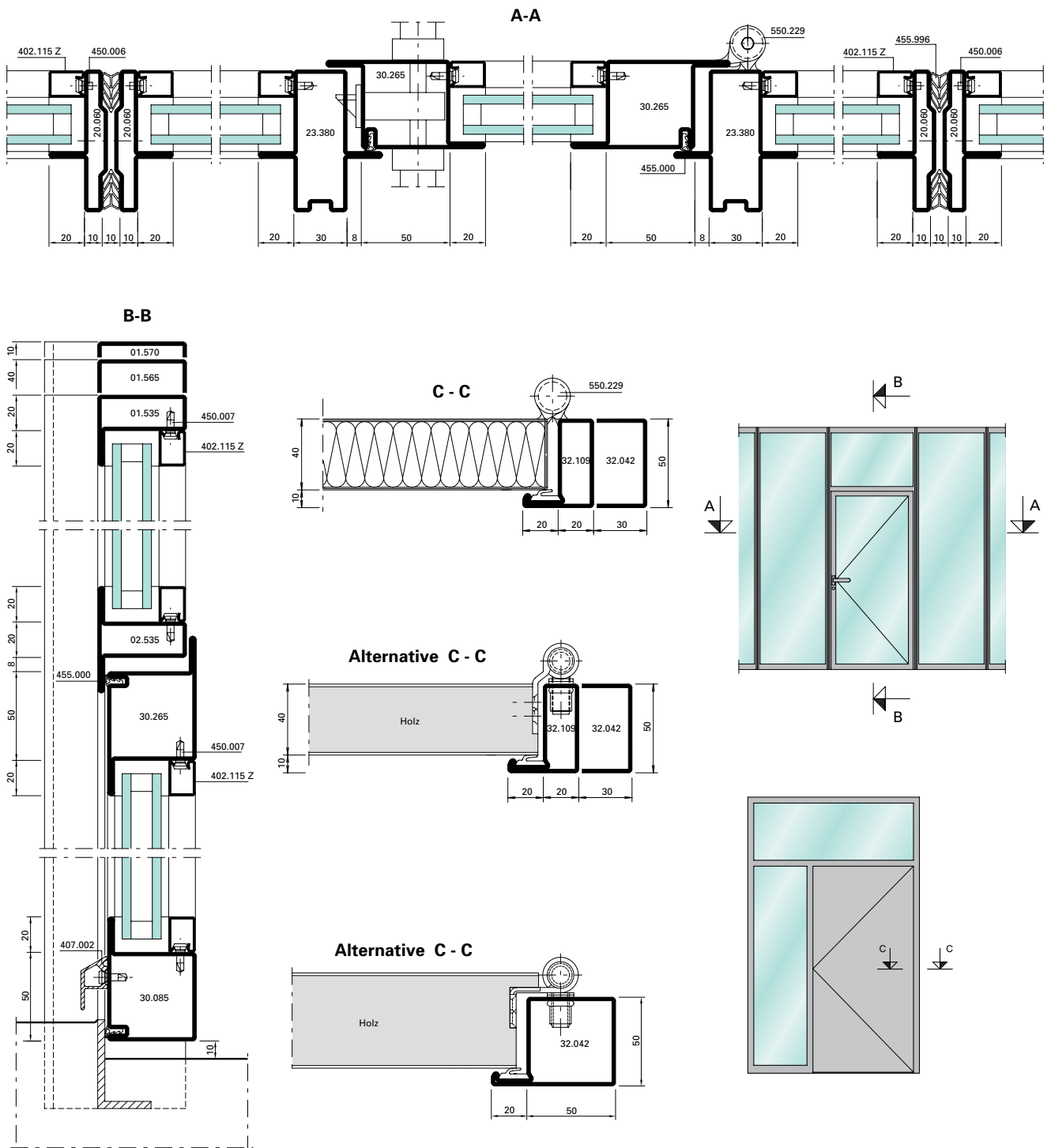

Personal Profiles

Attractive and economical

Laser-welded combinations

Here is a series of examples of different combinations of Jansen system profiles with add-on steel tubes or drawn flat steel.

These lightweight steel profiles provide architects and designers with a range of creative possibilities for the design and construction of doors, windows and façade units. Use our configurator to help you create your own personal profile quickly and easily.

Personal profiles give the developer greater freedom:

- In design and function thanks to the practical modular system
- Joins existing profiles using state-of-the-art laser welding technology
- Individual, standard add-on profiles
- Continuous welding and an even, barely visible welded seam

Personal profiles make steel systems attractive and economical

- Efficient processing thanks to high degree of precision
- Economical production even for small quantities
- No tooling costs for new profile combinations
- Simplifies procurement and production planning for the metal fabricator





Glazing beads

Steel and aluminium

Steel glazing beads made of hot-dip galvanised strip (length 6 m)

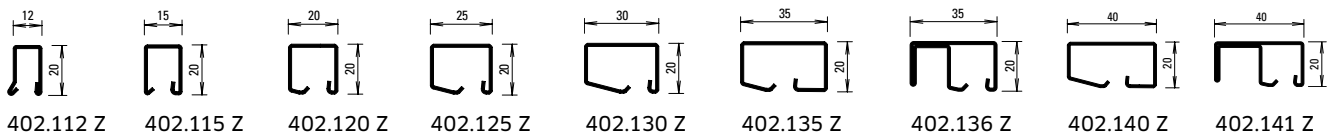

Stainless steel glazing beads (length 6 m)

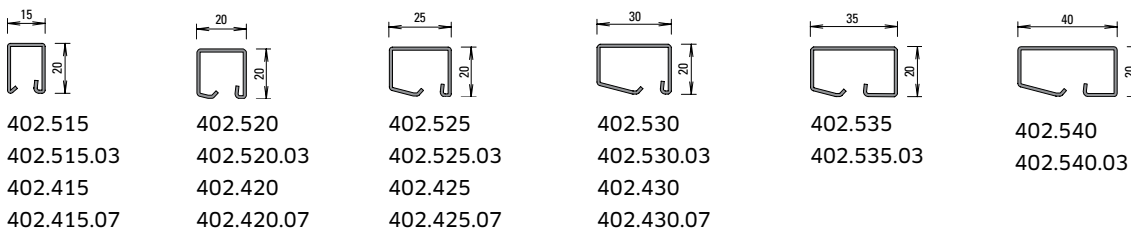

Aluminium glazing beads (length 6 m)

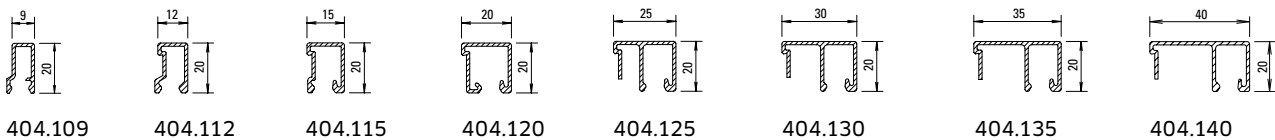

Angle contour steel glazing beads (length approx. 6 m)

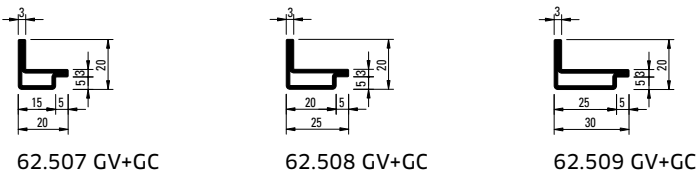

Aluminium glazing beads (length 6 m)

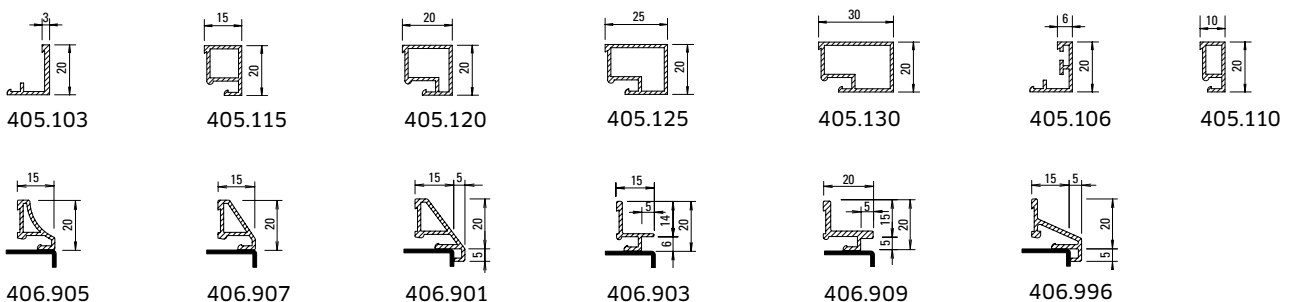





System versatility: for every application

Systems	Windows	Doors	Façades	Fixed glazings	Partition walls	Conservatories	Fire protection	Thermal insulation	Safety	System specifications
Janisol/Janisol Primo Basic depth of doors 60 mm Basic depth of windows 60/64 mm	◆	◆		◆	◆	◆		◆	◆	Doors and windows CE tested, anti-finger-trap door, folding wall, burglar resistance RC3 and bullet resistance, steel and stainless steel
Janisol HI Basic depth of doors 80 mm Basic depth of windows 90 mm	◆	◆		◆	◆	◆		◆	◆	Doors and windows CE tested, Minergie tested, highly insulated, windows RC3
Janisol Arte Basic depth 60 mm	◆			◆	◆	◆		◆		Windows CE tested, inward and outward opening windows, very slim face widths
Janisol 2 Basic depth 60 mm/70 mm		◆		◆	◆		◆	◆	◆	Doors and fixed glazings, fire resistant tested EI30, smoke protection, burglar resistance, steel and stainless steel
Janisol C4 Basic depth 70 mm		◆		◆	◆		◆	◆		Doors and fixed glazings, fire resistant tested EI60 and EI90, smoke protection
VISS TV Face width 50/60 mm			◆	◆	◆			◆	◆	Mullion-transom construction for vertical glazings, dry glazing, CE tested, burglar resistance RC4 and bullet resistance
VISS TVS Face width 50/60 mm			◆	◆	◆			◆	◆	Mullion-transom construction for vertical and roof glazings, dry glazing, CE tested, burglar resistance RC4 and bullet resistance
VISS Fire Face width 50 mm			◆	◆			◆			Mullion-transom construction for vertical and roof glazings, tested for fire resistance to E90/EI90
VISS SG Face width 50/60 mm			◆	◆	◆			◆		Structural Glazing façade based on the tried-and-tested VISS system
VISS Basic / VISS I _{tra}			◆	◆				◆	◆	Construction for steel and stainless steel façades for mounting on any support
Jansen-Economy 50 Basic depth of doors 50 mm Basic depth of windows 50/58,5 mm	◆	◆		◆	◆		◆		◆	Doors and windows CE tested, anti-finger-trap door, fire resistant tested E30, smoke protection, burglar resistance, steel and stainless steel
Jansen-Economy 60 Basic depth 60 mm		◆		◆	◆		◆		◆	Doors CE tested, anti-finger-trap door, fire resistant tested E30, smoke protection, burglar resistance and bullet resistance
Standard profiles Basic depth 40, 50, 60, 80 mm	◆	◆		◆	◆					Steel profile series for double action doors, frame doors and pilaster profiles
Folding and sliding doors Basic depth 50, 60, 80 mm										Steel profiles for folding and sliding doors, automatic or manual folding, CE tested

Jansen AG

Steel Systems
Industriestrasse 34
9463 Oberriet
Schweiz
jansen.com

JANSEN
Configure to Inspire